

TECHNICAL MANUAL

**OPERATOR'S, ORGANIZATIONAL, DIRECT SUPPORT, AND
GENERAL SUPPORT MAINTENANCE MANUAL
(INCLUDING REPAIR PARTS AND SPECIAL TOOLS LIST)**

**GRAPHICAL DISPLAY SYSTEM,
TEKTRONIX TYPE 561 SERIES**

**This copy is a reprint which includes current
pages from Change 1.**

HEADQUARTERS, DEPARTMENT OF THE ARMY

OCTOBER 1972

NOTE

This manual is an authentication of the manufacture's commercial literature which, through usage, has been found to cover the data required to operate and maintain this equipment. Since the manual was not prepared in accordance in with military specifications, the format has not been structured to considered level of maintenance nor to include a formal section on depot overhaul standards.

This manual contains copyrighted information. Reproduced by permission of Tektronix, Incorporated. All rights reserved.

**OPERATOR'S ORGANIZATIONAL, DIRECT SUPPORT AND
GENERAL SUPPORT MAINTENANCE MANUAL,
INCLUDING REPAIR PARTS AND SPECIAL TOOLS LIST:
GRAPHICAL DISPLAY SYSTEM
TEKTRONIX TYPE 561 SERIES (NSN 4931-0(1-910-8164)
Current as of 16 April 1986**

TM 9-6625-963-14-1, 11 October 1972, is changed as follows:

1. Remove old pages and insert new pages as indicated below. New or changed material is indicated by a vertical bar in the margin of the page.

Remove pages

0 -1 and 0 -2
12 - 1 through 12 - 11

Insert pages

0 -1 and 0 -2
12 - 1 through 12 - 16

2. File this change sheet in front of the publication for reference purposes.

By Order of the Secretary of the Army:

JOHN A. WICKHAM, JR.
General, United States Army
Chief of Staff

Official:

R. L. DILWORTH
Brigadier General, United States Army
The Adjutant General

Distribution:

To be distributed in accordance with DA Form 12-34C, Block No. 319, requirements for calibration procedures publications.

CHANGE
NO. 1



HEADQUARTERS
DEPARTMENT OF THE ARMY
WASHINGTON, D.C. 20 MARCH 1975

**OPERATOR'S, ORGANIZATIONAL, DIRECT SUPPORT,
AND SUPPORT MAINTENANCE MANUAL,
INCLUDING REPAIR PARTS AND SPECIAL TOOLS LIST:
GRAPHICAL DISPLAY SYSTEM, TEKTRONIX
TYPE 561 SERIES (NSN 4931-00-910-8164)**

Current as of 11 September 1974

TM 9-6625-963-14-1, 11 October 1972, is changed as follows:

1. The title is changed to read as shown above.
2. Remove old pages and insert new pages as indicated below. New or changed material is indicated by a vertical bar in the margin of the page.

Remove pages

i and ii

Insert pages

i and ii
12-1 through 12-11

3. File this change sheet in front of the publication for reference purposes.



**OPERATOR'S ORGANIZATIONAL, DIRECT SUPPORT, AND
GENERAL SUPPORT MAINTENANCE MANUAL**

**INCLUDING REPAIR PARTS SPECIAL TOOL LIST
GRAPHICAL DISPLAY SYSTEM,**

TEKTRONIX TYPE 561 SERIES

(NSN 4931-00-910-8164)

		Page
SECTION	0	INTRODUCTION.....0-1
	1	CHARACTERISTICS RM561A..... 1-1
	1A	TYPE R561B SPECIFICATION 1-1A
	2	OPERATING INSTRUCTIONS RM561A.....2-1
	2A	OPERATING INSTRUCTIONS R561B 2-1A
	3	CIRCUIT DESCRIPTION RM561A3-1
	3A	CIRCUIT DESCRIPTION R561B 3-1A
	4	MAINTENANCE RM561A4-1
	4A	MAINTENANCE R561B 4-1A
	5	PERFORMANCE CHECK RM561A.....5-1
	5A	PERFORMANCE CHECK VIRGULE MAINTENANCE CALIBRATION R561B..... 5-1A
	6	MAINTENANCE CALIBRATION RM561A.....6-1
		PARTS LIST ABBREVIATIONS..... 7-0.1
	7	ELECTRICAL, PARTS LIST.....7-1
	8	MECHANICAL, PARTS LIST8-1
	9	DIAGRAMS9-1
	10	PREVENTIVE MAINTENANCE INSTRUCTIONS.....10-1
	11	RACKMOUNTING.....11-1
	12	REPAIR PARTS LIST12-1
Appendix	A	REFERENCES..... A-1
	B	BASIC ISSUE ITEMS LIST AND ITEMS TROOP INSTALLED OR AUTHORIZED LIST..... B-1
	C	MAINTENANCE ALLOCATION CHART C-1

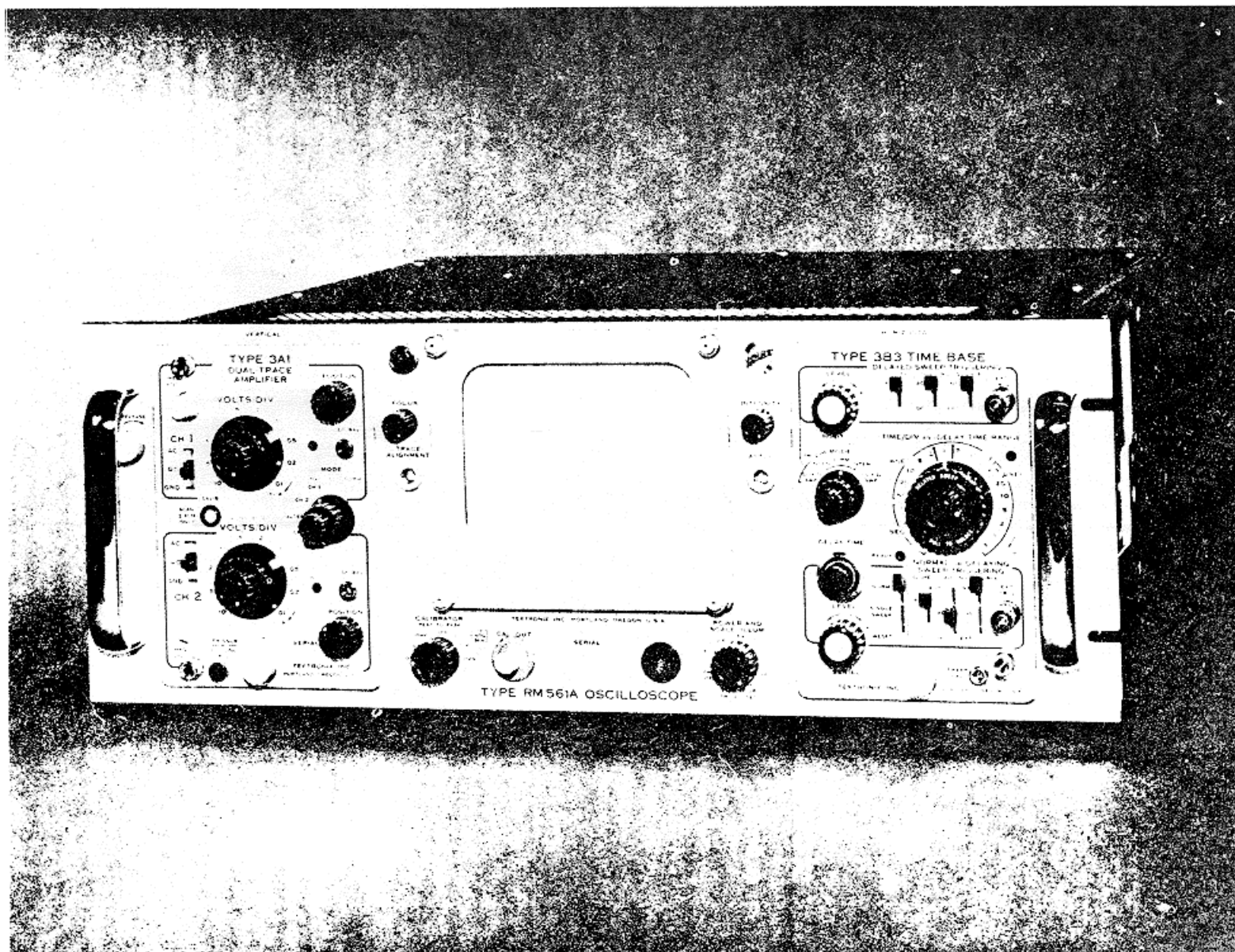

Figure 1-1A. Type RM561A Oscilloscope

SECTION 0

INTRODUCTION

Scope

The manual includes installation and operation instructions and covers organizational, direct support (DS), and general support (GS) maintenance. It describes Graphical Display System, Tektronix Type 561 Series. The basic issue items list appears in appendix B. Appendix 'B' is current as of 1 September 1972.

Indexes of Publications

DA Pam 310-4. Refer to the latest issue of DA Pam 310-4 to determine if there are any new editions, changes, or additional publications pertaining to the equipment.

DA Pam 310-7. Refer to DA Pam 310-7 to determine whether there are Modification Work Orders (MWO) pertaining to the equipment.

Forms and Records

Reports of Maintenance and Unsatisfactory Equipment. Use equipment forms and records in accordance with instructions given in TM 38750.

Report of Packaging and Handling Deficiencies (DD Form 6). Fill out and forward DD Form 6 as prescribed in AR 700-8 (Army), NAVSUP Pub 378 (Navy), AFR 71-41 (Air Force), and MCO P4030.29 (Marine Corps).

Discrepancy in Shipment Report. Fill out and forward Discrepancy in Shipment Report (SF 361) as prescribed in AR 55-38 (Army), NAV SUPINST 4610.33 (Navy), AFM 7-18 (Air Force), and MCO P4610.19A (Marine Corps).

Reporting of Equipment Publication Improvements. The reporting of errors, omissions, and recommendations for improving this publication by the individual user is encouraged. Reports should be submitted on DA Form 2028 (Recommended Changes to Publications) and forwarded direct to: Commander, U. S. Army TMDE Support Group, ATTN: AMXTM-LML, Redstone Arsenal, AL 35898-5400.

Change 2 0-1

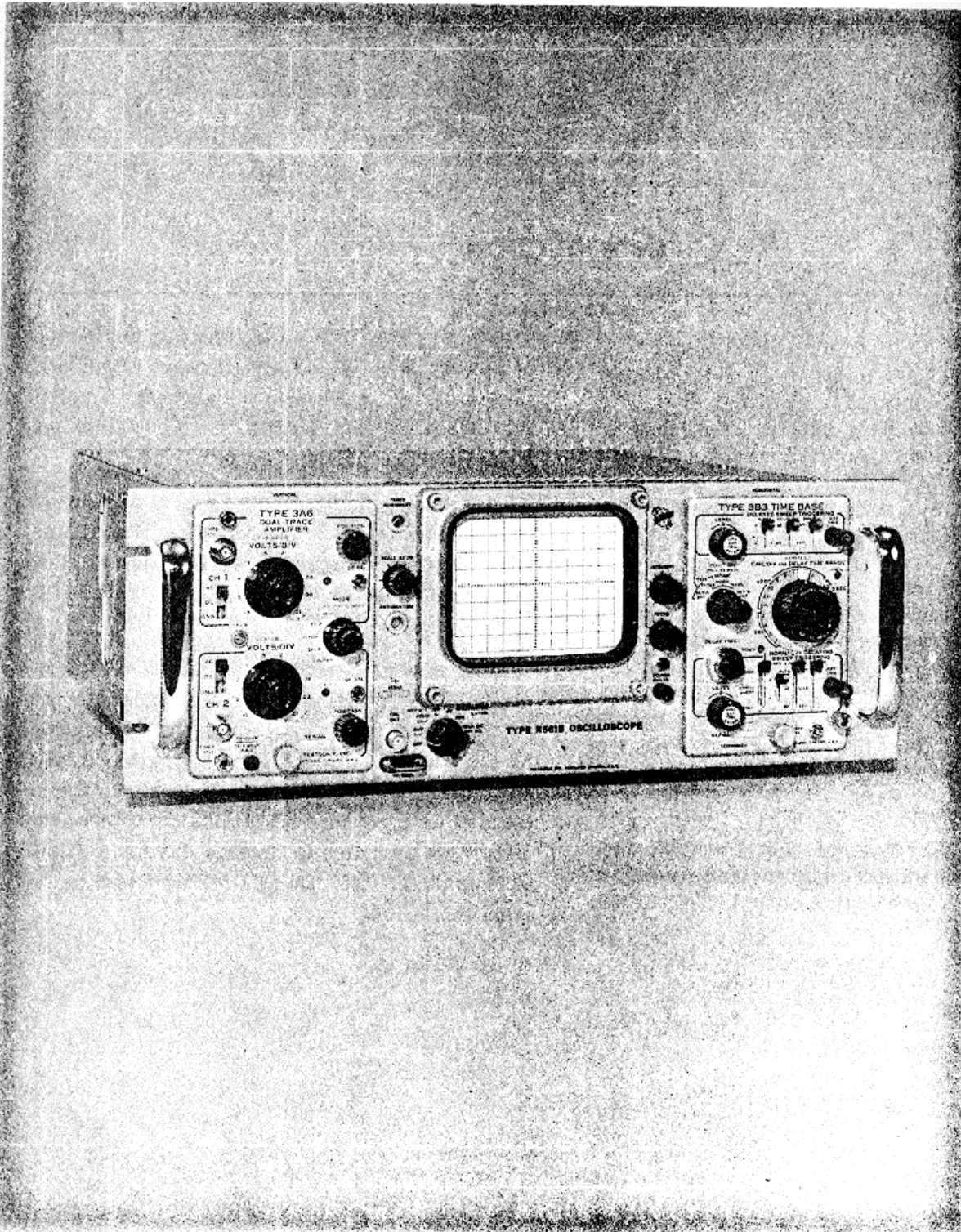

Fig. 1-1. Type R561B Oscilloscope.

SECTION 1

CHARACTERISTICS RM561A

General Information

The Tektronix Type RM561A Oscilloscope is essentially an indicator unit with provision for two plug-in units. The plug-in unit in the right-hand opening controls the horizontal (X-axis) deflection, and the plug-in unit in the left-hand opening controls the vertical (Y-axis) deflection. The plug-in units can be selected from any of the Tektronix '2' Series or '3' Series groups to provide the desired oscilloscope performance.

Cathode-Ray Tube

Type - T5032-31-1 (rectangular ceramic-envelope).

Phosphor-P31.

Unblanking - Deflection type, dc-coupled, with grid intensification.

Graticule - Variable edge lighted "no parallax" internal graticule. Marked in 8 vertical and 10 horizontal divisions with each major division divided into 5 minor divisions on centerlines.

Accelerating voltage - 3.5 kv.

Useable viewing area - 8 divisions vertical by 10 divisions horizontal.

Deflection meters - 18.5 to 20.5 volts per centimeter vertical, and 17.5 to 19.3 volts per centimeter horizontal.

Calibrator

Waveform - Square waves at line frequency.

Output voltage - 1 millivolt to 100 volts, peak-to-peak, in 6 steps. The 1 v position provides an output of 0.1 volt into 50 ohms.

Accuracy - Peak-to-peak amplitude within 3% of indicated voltage.

Rise-time - Typically 5 microseconds.

Power Supplies

Electronically regulated for stable operation with normal line voltage variations and widely varying loads. The low voltage supplies hold regulation within $\pm 1\%$ of value.

Line voltage requirements - 105 to 125 volts, or 210 to 250 volts, rms, 50 to 60 cps, single-phase ac.

Fuse requirements - 3-amp slow-blowing type for 117 volts, 1.25-amp slow-blowing type for 234 volts.

Ventilation

Forced air cooled. Automatic-resetting thermal cutout interrupts instrument power if internal temperature exceeds about 123° F.

Construction

Aluminum-alloy chassis.

Photo-etched anodized front panel.

Weight - 30-1/2 pounds, indicator unit only.

Dimensions - see Dimension Drawing at rear of manual.

SECTION 1A

TYPE R561B SPECIFICATION

Introduction

The Type R561B Oscilloscope is compatible with Tektronix 2-Series and 3-Series plug-in units (see following table and Section 2 for exceptions); thus, it can be used in a variety of applications including differential, multi-trace, wide-band, delayed sweep, sampling and spectrum analysis.

This instrument will perform to the specifications listed in this section in a laboratory environment with ambient temperature range between 0°C and +50°C, except as indicated. Warm-up time for rated accuracy is 5 minutes (certain plug-ins may require additional warmup time). The Performance Check instructions outlined in Section 5 provide a convenient method of checking the performance of this instrument.

**ELECTRICAL CHARACTERISTICS
DISPLAY**

Characteristics	Performance
Plug-in Compatibility	2- and 3-Series plug-ins, except the 3S6, 3T6, 385 (horizontal only)
CRT Type	Electrostatic deflection
Graticule Area	8 x 10 cm
Phosphor	P31
Typical CRT Accelerating Voltage	3.5 kV

EXTERNAL INPUTS AND OUTPUTS

CRT Cathode Input (AC Coupled) Low - 3 dB Frequency	1.8 kHz or less
Z Axis Modulation	10 V or less (P-P) gives useful intensity variation
Maximum Input Voltage	150 V
Calibrator Output Voltages Into High Impedance (1 M Ω or greater)	+4 mV, +40 mV, +0.4 V, +40 V (ground to peak) square wave and 40 VDC (within 1-1/2%, +20°C to +30°C; 2%, 0°C to +50°C
Into 50.0 Ω	+2mV, +20mV, +0.2V (ground to panel) square wave (within 1-1/2%, +20°C to +30°C; 2%, 0°C to +50°C
Current Loop	10mA DC or 10mA (P-P) square wave (within 1-1/2%, +20°C to +30°C; 2%, 0°C to +50°C

(A)

Frequency	1 kHz within 1%
Duty Factor	48% to 52%
Rise-time and Fall-time	1 μ s or less at all voltages with load capacitance of 100pF or less, except 40 V, 2.5 μ s or less at 40 V with load capacitance at 100 pF or less

POWER SUPPLY

Line Voltage	115 VAC	230 VAC
Low	90 V to 110 V	180 V to 220 V
Medium	104 V to 126 V	208 V to 252 V
High	112 V to 136 V	224 V to 272 V
Line Frequency Range	48 Hz to 66 Hz	
Maximum Power Consumption at 115 VAC, 60 Hz	186 W, 2.02 A	

ENVIRONMENTAL CHARACTERISTICS

Characteristics	Performance
Temperature Non-operating Operating	-40°C to +65°C 0°C to +50°C
Altitude Non-operating Operating	To 50,000 feet To 15,000 feet

PHYSICAL

Finish	Lacquered aluminum panels. Anodized aluminum front panel
Dimensions	
Height	\cong 7 inches
Width	\cong 19 inches
Length	\cong 20-1/2 inches

Accessories

Standard accessories supplied with the Type R561B are listed on the last pullout page of the Mechanical Parts List illustrations. For optional accessories available for use with this instrument, see the current Tektronix, Inc. catalog.

SECTION 2 OPERATING INSTRUCTIONS RM561A

Introduction

Before operating the Type RM561A Oscilloscope, be sure that the instrument will cool properly, the proper line voltage is used and the crt deflection potentials are correct. Function of front-panel controls and operating considerations are given in this section.

Cooling

A fan at the rear of the Type RM561A provides cooling. The entire fan assembly is in a snap-in mounting that can be mounted to exhaust air at the rear of the instrument or draw air in at the rear and blow it throughout the instrument. Direction of air flow can be changed to meet the operating conditions.

The Type RM561A can operate in ambient temperatures up to 50°C. If the instrument overheats, the thermal cutout turns off the power. When the internal temperature drops to a safe operating level, power is automatically restored. If wired for 117-volt operation, the fan will continue to operate when the thermal cutout opens. On 234-volt operation, power for the fan is turned off when the thermal cutout opens.

Line Voltage

The Type RM561A can be wired for either 117-volt or 234-volt operation. It will operate properly between 105 and 125 volts when wired for 117-volt operation and between 210 and 250 volts when wired for 234-volt operation. Converting from one operating voltage to the other requires a change in the power transformer primary connections, fan connections, fuse and line cord plug. Figs. 2-1 and 2-2 indicate the transformer primary and fan connections for

117-volt and 234-volt operation. A 3-amp slow-blow type fuse is required for 117-volt operation and a 1.25-amp slow-blow type fuse is required for 234-volt operation.

Front Panel Controls

The POWER ON switch and SCALE ILLUM. control permit turning the instrument power on or off and provide adjustment of the brightness of the graticule markings.

The FOCUS control adjusts the trace or spot focus.

The ASTIG. control is used in conjunction with the FOCUS control, to assure proper focus over the entire crt display.

The INTENSITY control adjusts the crt display brightness.

The ALIGNMENT control permits electronic alignment of the crt trace to match the horizontal graticule markings.

The 7-position CALIBRATOR switch determines the peak-to-peak amplitude of the signal at the CAL. OUT connector. It also turns the Calibrator on or off.

Rear Panel Controls

The CRT CATHODE SELECTOR switch permits the operator to select either (1) internal DUAL-TRACE CHOPPED BLANKING to remove dual-trace chopped mode switching transients from the crt display, or (2) Z-axis intensity modulation by external signals.

Operation

Operation of the Type RM561A Oscilloscope with two plug-in units in place is much the same as that of a Tektronix oscilloscope with corresponding vertical and horizontal deflection systems built into the main frame. The plug-in

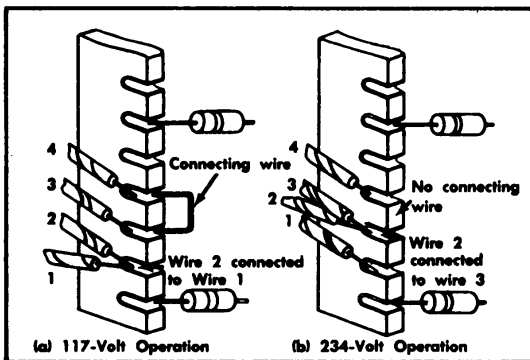

Fig. 2-1. Power transformer primary connections for operation at (a) 117 volts or (b) 234 volts.

(A)(A)

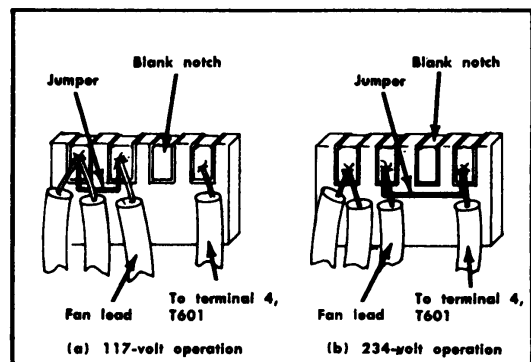

Fig. 2-2. Fan terminal strip located near thermal cutout. (a) 117 volts, (b) 234 volts.

Operating Instructions--Type RM561A

units are the vertical and horizontal deflection systems; their outputs connect directly to the deflection plates of the cathode-ray tube. The plug-in units can be selected to give the Type RM561A Oscilloscope the degree and type of performance required for a particular application.

The controls and switches on the Type RM561A affect the display; however, the plug-in units determine the major characteristics of the system.

Calibrator Output

The Calibrator output signal of the Type RM561A provides a convenient signal source for setting the gain of an amplifier plug-in unit or the basic timing of a time-base plug-in unit. The 1 V position also provides a 0.1 volt amplitude signal when connected to a 50-ohm system. This is very useful for calibrating sampling plug-in units. See the plug-in unit Instruction Manual for complete adjustment procedure.

In addition to these applications, the Calibrator output signal can be used as a convenient square-wave signal source for other applications.

NOTE

When using the Calibrator output signal as a signal source for a system sharing a common ground with the Type RM561A (including plug-ins used in the instrument) be sure that the outer conductor of the CAL. OUT connector is connected to the chassis (or ground). Otherwise, the current through the Calibrator ground resistor, R899, may cause an incorrect Calibrator output signal.

CRT CATHODE SELECTOR Switch

The CRT CATHODE SELECTOR switch provides two modes of operation; CHOPPED BLANKING for dual-trace amplifier plug-ins and EXT CRT CATHODE for intensity modulation of the display.

The CRT CATHODE SELECTOR switch should be left in the CHOPPED BLANKING position except when external intensity modulation is used. For normal operation the shorting plug should connect the EXT CRT CATHODE jack to ground. Remove the plug for Z-axis modulation:

Display Combinations

The plug-in unit in the right opening of the Type RM561A controls the horizontal (X-axis) deflection of the crt beam. The unit in the left opening controls the vertical (Y-axis) deflection.

Conventional Display. To obtain the conventional display of a horizontal sweep with vertical deflection by the input signal, insert a time-base plug-in unit in the right-hand opening and

an amplifier unit in the left. If a vertical sweep is desired with the input signal displayed horizontally, reverse the plug-ins. However, in this manner, the sweep retrace will not be blanked. Retrace blanking is provided only when a time-base unit is inserted in the right side of the Type RM561A.

X-Y Display. To obtain an X-Y display, insert amplifier plug-in units in both plug-in openings. Plug-in units with equal characteristics should be used.

Intensity Modulated Display. The crt beam can be intensity modulated, (Z-axis modulated) by applying a signal to the EXT CRT CATHODE jack on the rear panel. Depending on the setting of the INTENSITY control, the crt beam can be turned on with a negative pulse, or off with a positive pulse.

To intensity modulate the display remove the shorting strap from between the EXT CRT CATHODE and GND jacks. Set the CRT CATHODE SELECTOR switch to the EXT CRT CATHODE position and apply the modulating signal to the EXT CRT CATHODE jack.

Changing Plug-in Units

Before inserting a plug-in unit into the Type RM561A Oscilloscope, make sure the latching bar (bottom front) is not pointing down., Then, push the plug-in unit all the way into the opening. Turn the aluminum knob at the bottom center of the unit clockwise until it is tight. To remove the unit, turn the knob counterclockwise several turns and pull the unit out of the plug-in compartment.

CAUTION

Although most plug-in units can be inserted or removed without damage when the power is on, best protection is provided for all units by turning the power off before changing units.

Different plug-in units apply slightly different dc voltages to the crt deflection plates. The Type RM561A crt has higher horizontal deflection sensitivity than vertical deflection sensitivity. Also, changing one plug-in unit can affect the accuracy of the other unit installed. Therefore, if one or both of the units are replaced, check the gain of both units. If a plug-in needs adjustment, follow the directions in the applicable Instruction Manual to adjust gain or sweep timing.

When the plug-in units are changed, the FOCUS and ASTIG, controls on the Type RM561A may need readjustment.

The Type RM561A can be operated with only one plug-in unit if desired. For example, moving film recording may be used in place of a sweep plug-in unit. To operate with only one plug-in unit, it will be necessary to elevate the unconnected crt deflection plates to about +170 to +210 volts dc vertical or +150 to +180 volts dc horizontal. This will provide proper action of the FOCUS and ASTIG. controls.

(A)(A)

SECTION 2A OPERATING INSTRUCTIONS R561B

Introduction

To effectively use the Type R561B, the operation and capabilities of the instrument must be understood. This section of the manual describes the operation of the front- and rear-panel controls and connectors, and gives first time and general operating information.

Rack-mounting

Complete information for rack-mounting installation of the Type R561B is given on the Rack-mounting fold-out pages at the back of this manual.

Line Voltage

The Type R561B can be operated from either a 115-volt or a 230-volt nominal line-voltage source. The Line Voltage Selector assembly on the rear panel converts the instrument from one operating range to the other. In addition, this assembly changes the primary connections of the power transformer to allow selection of one of three regulating ranges. The assembly also includes two fuses to provide the correct protection for the instrument; both fuses are connected for 230-volt nominal operation, and only one fuse is connected for 115-volt nominal operation. Use the following procedure to obtain the proper line voltage and regulating range settings of the Line Voltage Selector.

1. Disconnect the instrument from the power source.
2. Loosen the two captive screws which hold the cover onto the voltage selector assembly; then pull to remove the cover.
3. To convert from 115 volts nominal to 230 volts nominal line voltage, pull out the Voltage Selector switch bar (see Fig. 2-1); turn it around 180° and plug it back into the remaining holes. Change the line-cord power plug to match the power-source receptacle or use a 115- to 230-volt adapter.
4. To change regulating ranges, pull out the Range Selector switch bar (see Fig. 2-1); slide it to the desired position and plug it back in. Select a range which is centered about the average line voltage to which the instrument is to be connected (see Table 2-1).
5. Re-install the cover and tighten the two captive screws.
6. Before applying power to the instrument, check that the indicating tabs on the switch bars are protruding through the correct holes for the desired nominal line voltage and regulating range.

CAUTION

Damage to the instrument may result from incorrect Line Voltage Selector settings.

(A)

TABLE 2-1
Regulating Ranges

Range Selector Switch Position	Regulating Range, 115-Volts Nominal	230-Volt Nominal
LO (switch bar in left holes)	90 to 110 volts	180 to 220 volts
M (switch bar in middle holes)	104 to 126 volts	208 to 252 volts
HI (switch bar in right holes)	12 to 13 volts	224 to 272 volts

Operating Temperature

The Type R561B can be operated where there ambient air temperature is between 0°C and +50°C. The instrument can be stored in ambient temperatures between -40°C and +65°C. After storage at a temperature beyond the operating limits, allow the chassis temperature to come within the operating limits before power is applied.

A fan at the rear of the Type R561B provides forced air cooling of the instrument. For proper circulation of air the instrument should normally be operated with the top and bottom covers in place. Do not block or restrict the air flow through the instrument.

A thermal cutout provides thermal protection and disconnects the power to the instrument if the internal temperature exceeds a safe operating level. This device will automatically reapply power when the temperature returns to a safe level.

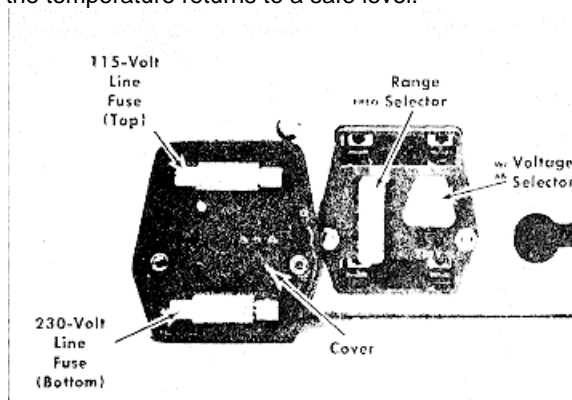

Fig. 2-1. Line Voltage Selector assembly on the rear panel (shown with cover removed).

Operating Instructions--Type R561B

SELECTION OF PLUG-IN UNITS

General Information

The Type R561B is designed to use Tektronix 2-series and 3 series amplifier and time-base plug-in units for amplifying the vertical input signal and producing the time-base sweep. The use of plug-in permits the selection of display modes, bandwidth, sensitivity and number of inputs so that the oscilloscope performance can be changed to meet changing measurement needs.

NOTE

Programmable plug-in Types 3S6 and 3T6 are not compatible with the Type R561B. However, the capability of these plug-ins is available (without programmability) with Types 3S5 and 3T5. Use the Type 3B5 in the right-hand (horizontal) compartment only. Refer to the instruction manual of the plug-in unit for specific information.

To install a plug-in unit in the Type R561B, push it all the way in to the plug-in compartment, then turn the locking knob (at the bottom of the front panel) clockwise until it is tight. To remove the unit, turn the knob counterclockwise until the latch releases, then pull the unit out.

The accuracy of measurements made with the Type R561B depends on the calibration of the plug-in units used. Since the plug-in units drive the deflection plates directly, each unit must be adjusted to match the deflection sensitivity of the particular CRT that it drives. Therefore, the gain or sweep timing adjustment must be checked each time a plug-in unit is changed. On most units, gain or timing calibration is made with a front-panel screwdriver adjustment. (Sampling units require special adjustment procedures.) Refer to the plug-in unit instruction manual for the required procedure. Since the various plug-in units present different output voltage levels to the deflection plates, the FOCUS and ASTIGMATISM controls will also require re-adjustment.

Plug-in units can be changed without turning off the instrument power, but it is recommended that the power be turned off while the change is made.

Either or both of the plug-in units can be operated on special extension cables for troubleshooting. For normal operation, power, the units must be installed in the oscilloscope. If the instrument is operated with the plug-in units on extension cables, the high-frequency response and fast sweep rates will be affected.

Display Combinations

The plug-in unit in the left plug-in compartment controls the vertical (Y-axis) deflection of the CRT beam, and the unit in the right plug-in compartment controls the horizontal (X-axis) deflection. The following paragraphs discuss some of the display combinations that can be obtained.

Time-Base Displays. To produce a conventional time-base, or Y-T display, an amplifier plug-in unit is used in the vertical (left) plug-in compartment and a time-base plug-in unit is used in the horizontal (right) plug-in compartment.

If a vertical sweep is desired with the input signal displayed horizontally, the time-base unit is inserted in the left compartment

and the amplifier unit in the right compartment. However, if a vertical sweep is used, there is no retrace blanking, no chopped blanking multi-trace displays and the delaying-sweep intensification does not operate because these circuits are associated with the horizontal (right) plug-in compartment.

X-Y Displays. Two amplifier units may be used to produce either a single or a multiple X-Y display (for example, for phase comparison measurement). Plug-in units with equal phase shift will produce an accurate X-Y display; however, for high-frequency X-Y operation, use of two units of the same type is recommended. Careful factory adjustment of deflection-circuit capacitance to a standard value in the Type R561B minimizes the high-frequency phase-shift between two plug-in units of the same type. For multiple X-Y displays, both synchronization and automatic pairings are provided for some amplifier units. Refer to the instruction manual of the plug-in unit to be used.

Multi-Trace Displays. The use of a dual-trace or multi-trace amplifier unit permits almost simultaneous viewing of two or more signals. For a multi-trace amplifier unit with single channel trigger capability ("Channel 1 Trigger"), the trigger signal is applied through the Type R531B to the trigger circuit in the time-base unit. This permits triggering from a single input signal and the CRT display shows the time relationship between the various signals. When using a plug-in without single-channel triggering, an external trigger is recommended to establish time relationship in multi-trace displays. In chopped mode, the multi-trace blanking pulses from the amplifier unit are applied internally through the Type R561 B to the CRT cathode to blank the CRT beam while it is switched from one channel to another (with the amplifier unit in the left compartment and the time-base unit in the right compartment, and with the rear panel CRT CATHODE SELECTOR switch in the CHOPPED BLANKING position).

Delayed Sweep. A delayed-sweep time-base unit is convenient for detailed viewing of pulse-train segments that occur a relatively long time after the maximum-amplitude (triggering) portion of the signal. The portion of the pulse train to be displayed by the delayed sweep may be intensified on the delaying-sweep display. A delayed-sweep unit that has a calibrated time delay can also be used for making very accurate (within 1%) time measurements

Raster Generation. A raster display can be presented by using two time-base units, one in each compartment. Intensity modulation can be achieved through the Z-axis of the CRT by applying the signal to the EXT INPUT connector on the rear panel and setting the CRT CATHODE SELECTOR to the EXT INPUT position.

Sampling. The apparent bandwidth of the oscilloscope can be increased to as much as one Gigahertz through the use of sampling plug-in units. A sampling time-base unit must be used with a sampling amplifier unit in the Type R561 B in order to produce the sampling display (even for X-Y operation). Generally, sampling and conventional plug-in units cannot be used together in the oscilloscope. However, Type 3S1 and 3S2 sampling amplifiers do have limited compatibility with conventional time-base units and the Type 3T5 sampling time-base unit can generate a real-time staircase sweep usable with conventional amplifiers.

Spectrum Analysis. Spectrum analyzer plug-in units can be used in conjunction with conventional time-base units

to produce a spectral display (a graph of the relative amplitude distribution as a function of frequency).

FUNCTIONS OF CONTROLS AND CONNECTORS

A brief description of the function or operation of the front- and rear-panel controls and connectors follows. See Fig. 2-2 for locations.

Front Panel

ASTIGMATISM (Screwdriver adjustment)	Used in conjunction with FOCUS control to obtain a well-defined display.
FOCUS Control	Used to optimize focus.
INTENSITY Control	Controls display brightness.
TRACE ALIGNMENT (Screwdriver adjustment)	Permits alignment of the trace with respect to the horizontal graticule lines.
SCALE ILLUM Control	Varies illumination of the graticule grid lines.
POWER Switch	Used to apply or remove instrument input power.
POWER Indicator	Lamp bulb which indicates that AC power is applied to the instrument.
CALIBRATOR Switch	Provides selection of one of several values of square wave voltage or a calibrated DC voltage. A calibrated DC or square wave current can also be selected.
CAL OUT Connector	BNC connector at which calibrator output voltage is available.
10 mA Current Loop	Convenient means for calibrating current probes.

Rear Panel

CRT CATHODE SELECTOR Switch	Permits selection of normal CRT operation, chopped blanking (blanking of the between-channel switching transients when using multi-channel plug-in units in the chopped mode) and external CRT cathode input (permitting intensity modulation of the CRT by an external signal).
-----------------------------	--

EXT INPUT Connector	BNC connector by which an external signal can be applied to the CRT cathode.
Line Voltage Selector	Provides quick method of changing transformer taps to allow instrument to operate over a wide range of line voltages.
Horizontal and Vertical Connector Holes	Permit installation of auxiliary inputs and outputs through rear panel.

FIRST TIME OPERATION

The following procedure, using normal single-channel time-base mode, will demonstrate the basic operation of this instrument and its plug-in units.

1. Install a 2-Series or 3-Series amplifier plug-in unit in the vertical (left) plug-in compartment and a 2-Series or 3-Series time-base plug-in unit in the horizontal (right) plug-in compartment. Lock the plug-in units in place with their locking screws.
2. Set the POWER switch to the off position (pushed in).
3. Connect the power cord from the Type R561B to the proper line voltage.

NOTE

The LINE VOLTAGE SELECTOR assembly on the rear panel should be checked to be sure the Voltage Selector and Range Selector switch bars are in the proper positions for the line voltage applied.

4. Set the instrument controls as follows:

Type R561B

INTENSITY	Counterclockwise
FOCUS	Centered
SCALE ILLUM	Counterclockwise
ASTIGMATISM (Screwdriver adjustment)	Centered
CALIBRATOR	4 V
CRT CATHODE SELECTOR (rear panel)	NORM

Amplifier Unit

(For example: Type 3A6)

Position	Centered
Mode	Normal (Channel 1)
Volts/Div	2
Variable (Volts/Div)	Calibrated
Input Coupling	DC

Time-Base Unit

(For example: Type 3B3)

Position	Centered
Time/Div	.5 ms
Variable (Time/Div)	Calibrated
Magnifier	Off
Sweep Mode	Normal

(A)

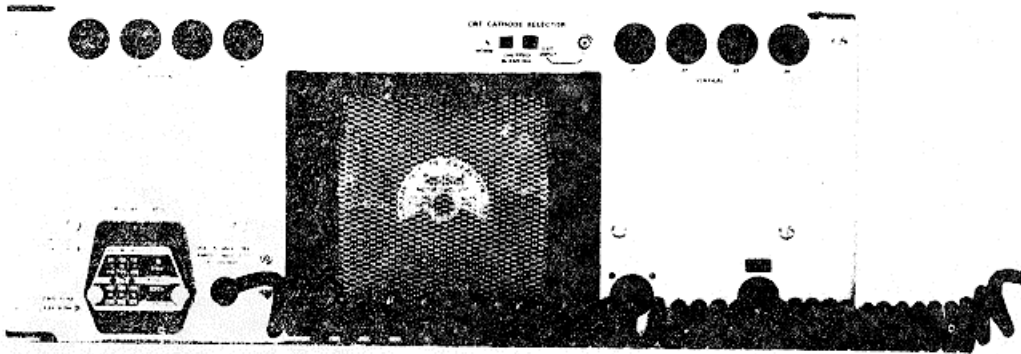
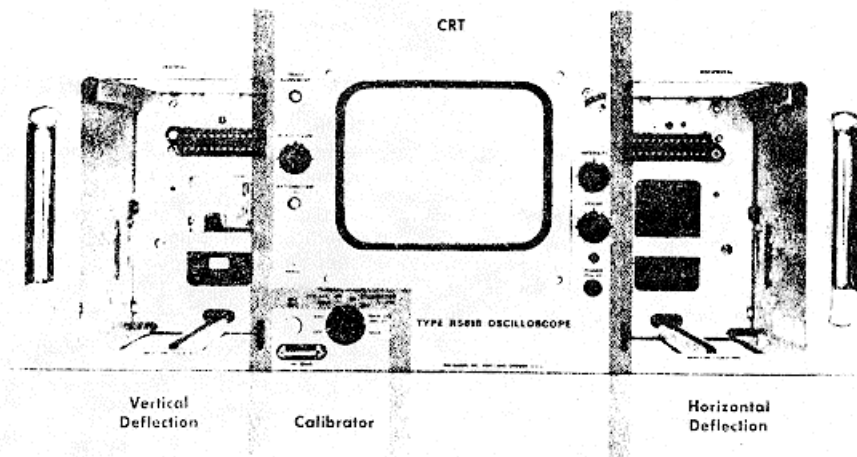

Fig. 2-2. Front-and rear-panel controls and connectors.

(A)

Operating Instruction--Type R561B

Normal-Single Sweep	Normal
Level	Free run (clockwise)
Triggering Source	Internal
Slope	+
Coupling	Auto

5. Connect a patch cord from the CAL OUT connector to the Channel 1 input connector of the amplifier plug-in unit.

6. Set the POWER switch to ON (pulled out) and allow a few minutes for warm up.

7. Adjust the INTENSITY control to obtain a display of moderate brightness. The amplifier unit Position control may have to be adjusted to position the free running trace on the CRT screen. Do not turn the intensity higher than is necessary for adequate observation of the display.

8. Trigger the display by adjusting the time-base Level control.

9. Set the SCALE ILLUM control so the graticule illumination is approximately equal to the intensity of the display.

10. Adjust the time-base Position control to position the start of the trace at the left edge of the graticule.

11. Adjust the FOCUS and ASTIGMATISM controls for a sharp well-defined display over the entire trace length. (If a focused display cannot be obtained, see Astigmatism Adjustment later in this section under General Operating Information.)

12. Adjust the TRACE ALIGNMENT screwdriver adjustment to align the display with the graticule lines.

13. Check the gain and DC balance of the amplifier unit and the timing adjustment (Sweep Cal) of the time-base unit as given in the instruction manuals for those units before making any voltage or time measurements. (In this demonstration, the calibrator waveform should be displayed as two divisions per cycle and two divisions in amplitude.)

GENERAL OPERATING INFORMATION

General

Refer to the amplifier unit manual for the following: Compensation of probes, selection and use of input cables, coupling and attenuation, and measurement of input signal voltage and phase (X-Y). Refer to the time-base unit manual for selection of triggering sources and coupling, and for measurements of time intervals, frequency and phase (linear measurement).

Scale Illumination

The CRT graticule is edge-lighted by three small lamps at the bottom. The lighting can be adjusted to suit the ambient light conditions by means of the SCALE ILLUM control. Rotating the control clockwise increases the brightness of the graticule scale markings.

Intensity Control

The setting of the INTENSITY control may affect the correct focus of the display. Slight adjustment of the FOCUS control may be necessary when the intensity level is changed.

(A)

Do not leave a bright, sharply focused spot on the CRT screen for a prolonged period. An excessively bright stationary spot may damage the CRT phosphor.

Astigmatism Adjustments

For most displays, the trace can be adequately focused using only the front-panel FOCUS control. However, whenever a large change is made in the beam intensity (to offset large changes in sweep rates or triggering repetition rates), or when plug-in units are changed, adjustment of the ASTIGMATISM control may also be required for a sharp display.

To check for proper setting of the ASTIGMATISM adjustment, slowly turn the FOCUS control through the optimum setting with a signal displayed on the CRT screen. If the ASTIGMATISM adjustment is correctly set, the vertical and horizontal portions of the trace will come into sharpest focus at the same position of the FOCUS control.

To set the ASTIGMATISM adjustment, use the following procedure:

1. Connect a 4 V Calibrator signal to the vertical input and set the corresponding Volts/Div switch to present 2.5 divisions of vertical deflection.

2. Set the Time/Div switch .2 ms.

3. Adjust the INTENSITY control so that the rising portion of the display can be seen.

4. Alternately adjust the FOCUS and ASTIGMATISM controls so that the horizontal and vertical portions of the display are equally focused.

Graticule

The graticule of the Type R561B is marked with eight vertical and 10 horizontal divisions. Each division is one centimeter square. In addition, each major division is divided into five minor divisions on the center vertical and horizontal lines. With the vertical gain and horizontal timing calibrated to the graticule, accurate measurements can be made from the CRT. The illumination of the graticule lines can be varied with the SCALE ILLUM control.

Trace Alignment Adjustment

If a free-running trace is not parallel to the horizontal graticule lines, set the TRACE ALIGNMENT adjustment as follows: position the trace to the center horizontal line, and adjust the TRACE ALIGNMENT adjustment so the trace is parallel with the horizontal graticule lines.

1 kHz Calibrator

The 1 kHz Calibrator provides a convenient source of square waves of known amplitude at an accurate frequency of one kilohertz. The output square-wave voltages available at the CAL OUT connector are 4 mV, 40 mV, 0.4 V, 4 V and 40V. The loading of a terminated 50 Ω system at the CAL OUT connector will provide output square-wave voltages of 2 mV, 20 mV and 0.2 V. A constant 40-volt DC level is also provided.

Operating Instructions--Type R561 B

The current link provides 10 milliamperes, available as either DC or a square-wave current signal, which can be used to check and calibrate current probe systems. This current signal is obtained by clipping the probe around current loop. The arrow indicates conventional current (i.e., positive to negative).

Intensity (Z-Axis) Modulation

Intensity modulation can be used to relate other voltage information to the display signal without changing the shape of the waveform. The modulating signal is AC-coupled to the CRT cathode through the rear-panel EXT INPUT connector and the CRT CATHODE SELECTOR switch. With the INTENSITY

control set correctly, a positive excursion will dim or blank the CRT beam, and a negative excursion will brighten the beam (see Section 1 for amplitudes).

Time markers may be applied for direct time reference of the display or for establishing the sweep rate when uncalibrated deflection is used. Fast-rise pulses of short duration provide best resolution with respect to time. If the markers are not time-related to the displayed wave-form, a single sweep display is required. If sine waves are used for Z-axis modulation, the minimum usable frequency is about 250 hertz, due to AC coupling at the input. Be sure the CRT CATHODE SELECTOR is in the NORMAL position when the EXT INPUT connector is not in use, to avoid random intensity modulation from stray signals.

(A)

SECTION 3

CIRCUIT DESCRIPTION RM561A

Introduction

The Tektronix Type RM561A Oscilloscope has a low-voltage power supply circuit, a cathode-ray tube circuit, and a calibrator.

The low-voltage power supply circuit provides the regulated and unregulated power used by the instrument and the plug-in units.

The crt circuit has the necessary controls and input facilities needed to give a sharp trace of useable intensity.

Two negative high-voltage power supply outputs are used for the cathode, focus element, and control grid of the crt.

The calibrator produces amplitude-calibrated square waves.

LOW-VOLTAGE POWER SUPPLY

The low-voltage power supply circuits have regulated outputs of -100, -12.2, +125, and -300 volts, and unregulated output of +420 volts. These circuits use silicon diode rectifiers and series-regulators. Each regulator circuit has a vacuum tube (or transistor, in the case of the -12.2-volt supply) in series with the load. This tube's series plate resistance (and current) is controlled to maintain a constant voltage drop across the load. For example, if the load increases the series tube plate resistance decreases to pass more current to the load. If the load decreases it passes less current. In both cases, the voltage across the load remains the same.

The -100-, +125-, and +300-volt regulated supplies require shunt resistors when supplying more current than can be handled by the series tube. A shunt allows some of the load current to bypass the supply-series-regulator tube. The size of the shunt is very important. If the shunt resistance is too high, the series tube can overheat; if the resistance is too low, the supply can fail to regulate. If a plug-in draws an amount of current that calls for a supply shunt, the correct shunt resistance is located in that plug-in unit. When the unit is plugged into the Type RM561A, the shunt is connected around the series regulator tube. The plug-in portion of the shunt is always in series with a resistor located in each power supply circuit.

Power for the Type RM561A Oscilloscope and its plug-in units is supplied through the power transformer T601. The two primary windings of T601 are connected in parallel for 117-volt operation, or in series for 234-volt operation, as shown on the schematic diagram.

- 100 Volt Supply

Reference voltage for the -100-volt supply is established by the gas diode, V609. The constant voltage drop across V609 establishes a fixed potential of about --85 volts at the grid of V634B. Voltage at the grid of V634A is established by the divider R616, R617, and R618. The difference in voltage between the two grids of V634 determines the plate current of V634A. Plate current of V634A determines the base voltage of transistor Q624 which in turn determines the grid voltage of the series tube, V627.

The series tube plate resistance changes to hold the load voltage constant. R616, -100 VOLTS adjustment, determines the percentage of the total divider voltage applied to the grid of V634A and thus controls the output voltage. When this control is properly adjusted, the output is exactly -100 volts.

Should the output voltage tend to change because of a change in input voltage or a change in load current, the potential at the grid of V634A will change a proportional amount. Any change at the grid of V634A is amplified by V634A and Q624 and applied to the grid of V627. The resulting grid change at V627 will cause its plate resistance to change in the direction needed to bring the output back to --100 volts. C616 improves the response of the regulator to sudden changes in output voltage R628 is part of the series tube shunt. connected by some plug-in units.

+ 125-Volt Supply

The -100-volt supply serves as a reference for the +125 volt supply. With the R651 end of the divider R650-R651 fixed at -100 volts, any change in the +125-volt output produces a proportional change at the grid of V654. This change is amplified and supplied to the grid of the series regulator tube, V667A. The change at the grid of V667A changes its plate resistance to bring the output voltage back to +125 volts. R656, the +125 VOLTS control, determines the percentage of total divider voltage applied to the grid of V654 and permits adjustment of the output voltage. When this control is properly adjusted, the output is exactly +125 volts. C650 improves the response of the regulator to sudden changes in output voltage. R666 is part of the series tube shunt.

+ 300-Volt Supply

The + 300-volt supply works the same as the + 125-volt supply. To supply the voltage for the + 300-volt regulator, rectified voltage from the transformer pins 21 and 22 is added to the voltage supplying the + 125-volt regulator. R676, the + 300 VOLTS control, adjusts the output voltage. The + 300-volt supply has an unregulated output of + 420-volts for the crt circuit.

- 12.2-Volt Supply

Operation of the --12.2-volt regulating circuit is essentially the same as that of the other regulating circuits, except that transistors are used instead of vacuum tubes. The base of Q734 is fixed near --12 volts by the voltage divider R731-R732 between ---100 volts and ground. Any variation of the --12.2-volt output at the emitter of Q734 is amplified by Q734 and Q744 to change the collector resistance of Q757 which is in series with the lead R730, the -12.2 VOLTS control, allows adjustment of the voltage applied to the base, of Q734 and thus the output voltage.

Circuit Description--Type RM561A

When this control is properly adjusted, the output is exactly -12.2 volts. F720 protects Q757 in case of an overload on the -12.2-volt supply.

CRT CIRCUIT

The crt circuit contains the cathode-ray tube and two high-voltage supplies (one for the crt and focus element, the other for the control grid). The circuit also contains the necessary controls and signal input facilities.

Cathode-Ray Tube

A Tektronix T5032-31-1 ceramic-envelope cathode-ray tube is used in the Type RM561A. The accelerating voltage is approximately 3500 volts, developed by about -3300 volts at the cathode and an average deflection plate voltage of about +200 volts. With this accelerating voltage, the nominal vertical and horizontal deflection factors are 19.5 and 18.4 volts per centimeter respectively.

Deflection blanking of the crt beam is used in the Type RM561A. The crt contains a special set of deflection plates, pins 6 and 7, for this purpose. Both plates are connected to +125 volts; however pin 6 is also driven by the horizontal plug-in unit.

During sweep time, or if no plug-in unit is installed, both plates rest at +125 volts and permit the electron beam to pass on to the crt phosphor. During sweep retrace, however, pin 6 is driven considerably away from +125 volts by the right-hand plug-in unit. This scatters the beam and prevents it from being displayed.

High-Voltage Supplies

Energy for both high-voltage supplies is furnished by T801. V800, the primary of T801, and the stray circuit capacitance form a Hartley oscillator which operates at about 45 kc.

The output of one secondary winding of T801, rectified by V822, provides voltage for the crt cathode and focus element. This voltage is about -3300 volts at the crt cathode, and between about -2200 and -3000 volts at the focusing element, depending on the setting of the FOCUS control. The 6.3-volt crt heater is elevated to the cathode potential by R851.

The output of the other secondary winding of T801 is rectified by V832 for the control grid. The grid voltage ranges from -3200 to -3450 volts, depending on the setting of the INTENSITY control. The reference to ground for this supply is determined by the voltage at the junction of diodes D838 and D839. The voltage at this junction, plus the setting of the INTENSITY control, determines the crt bias and therefore the intensity of the display.

Two neon bulbs, B856 and B857, keep the voltage between the grid and cathode of the crt within safe limits. If the voltage exceeds about 140 volts, the neons fire and the voltage reduces to about 120 volts.

Regulation of the -3300-volt supply is accomplished through feedback from the arm of R841. The -3450-volt supply is regulated indirectly by mutual coupling in T801. If, because of loading or a change in input voltage, the output of the -3300-volt supply changes, a proportionate change occurs at the arm of R841. This change is amplified by V814 and is coupled to the screen of V800. The resulting change in screen voltage of V800 will increase or decrease the amplitude of oscillations in V800, changing the output voltage of T801 in the direction needed to return the high voltage to the correct level. The HIGH VOLTAGE control, R841, permits adjustment of the output voltage by setting the bias on V814B.

Deflection Signals

Push-pull signals for the deflection plates appear at pins 17 and 21 of the plug-in connector. The effective deflection circuit capacitance these signals see at the connector affects the band-pass and phase shift of each plug-in unit. C760 and C761 (Interconnecting Socket diagram) are set at the factory.

Intensifying Signals

Two signals may be used to modulate the intensity of the crt display. First, intensifying signals from a two-sweep (delaying-sweep) time-base plug-in unit are applied to the grid supply through pin 14 of the right-hand Interconnecting Socket. When the overall display intensity is reduced with the INTENSITY control, positive intensifying pulses from a two-sweep time-base plug-in unit will brighten any desired portion of the display.

The ground return for the crt grid supply can be either through D838 in the case where the plug-in unit does not supply intensifying signals or through D839 to a negative voltage in the intensifying circuit of the plug-in unit. In the second case D838 is back-biased and the junction of D838 and D839 is at a low negative voltage. With the same setting of the INTENSITY control, the first case will provide a brighter display. The second case provides a slightly dimmer display due to the plug-in unit negative voltage. Intensification results when the plug-in unit positive pulse turns D839 off and the crt grid supply return again becomes D838. R837 and C837 then couple the leading edge of the intensifying pulse directly to the crt grid.

Other external intensifying signals can be fed to the crt cathode through the EXT CRT CATHODE jack. Depending on the setting of the INTENSITY control, a negative pulse of 5 volts or more will turn the crt beam on.

Crt Controls

The INTENSITY control, R833, has a range of about 250 volts to control the crt bias and permit changing the intensity of the display.

The FOCUS control, R844, adjusts the focus of the crt by varying the voltage at the focusing anode through a range from about -2200 to -3000 volts.

The ASTIG. control, R864, has a 300-volt adjustment range.

The GEOMETRY control, R865, adjusts the geometry by varying the voltage of the crt isolation shield through a range from +180 to +246 volts.

The TRACE ALIGNMENT control, R860, rotates the display so it can be aligned with the graticule.

CALIBRATOR

The calibrator for the Type RM561A Oscilloscope produces line-frequency amplitude-calibrated square waves. The 6.3-volt (approximately 18 volts peak-to-peak) ac heater voltage for V884 is supplied through C876 to the cathode of V884A. The signal at the plate of V884A is coupled to the grid of V884B to turn that tube on and off.

Regenerative feedback from the plate of V884B to the grid of V884A speeds up the switching action, and drives V884A into and out of cutoff.

The voltage present at the cathode of V884B during the time that V884B is conducting is adjusted to exactly 100 volts with the CAL. AMPL. adjustment, R871.

The voltage divider in the cathode circuit of V884B contains precision resistors to provide an output accuracy of 3% or better at the various settings of the CALIBRATOR control.

When the CALIBRATOR control is set to the IV position, there will be a 0.1-volt output when the CAL. OUT connector is terminated in 50 ohms.

(A)(A)

SECTION 3A CIRCUIT DESCRIPTION R561B

Introduction

This section of the manual contains a description of the circuitry used in the Type R561B Oscilloscope. Each circuit is described in detail using a detailed block diagram to show the interconnections between the stages in each major circuit and the relationship of the front-panel controls to the individual stages. Complete schematic diagrams are located at the rear of this manual.

LOW-VOLTAGE POWER SUPPLY

General

The Low-Voltage Power Supply circuit provides the operating power for this instrument from four regulated supplies. Electronic regulation is used to provide stable, low-ripple output voltages. Each regulated supply contains a short protection circuit to prevent instrument damage if a supply is inadvertently shorted to ground or to another supply. The voltage input stage includes the Voltage Selector Assembly which allows selection of the nominal operating voltage and regulating range for the instrument. Fig. 3-1 shows a detailed block diagram of the Low-Voltage Power Supply.

Power Input

Power is applied to the primary of transformer T1 through fuse F1, POWER switch SW1, thermal cutout TK1, Voltage Selector switch SW2 and Range Selector switch SW3. SW2 connects the split primaries of T1 in parallel for 115-volt nominal operation, or in series for 230-volt nominal operation. SW3 allows three ranges of regulation by changing the taps on the primary windings to fit different line requirements. A second fuse, F2, is connected into the circuit when SW2 is set to the 230V position to provide the correct protection for 230-volt operation.

Thermal cutout TK1 provides thermal protection by interrupting the power if the instrument overheats. When the temperature returns to a safe level, TK1 automatically closes to re-apply the power.

- 100 Volt Supply

The -100-Volt Supply provides the reference voltage for the remaining supplies. The output from the secondary of T1 is rectified by bridge rectifier D8A-D. This voltage is filtered by C9, then applied to the -100-Volt Series Regulator stage to provide a stable output voltage. The Series Regulator can be compared to a variable resistance which is changed to stabilize the output voltage. The conductance

of the Series Regulator stage is controlled by the Error Amplifier to provide the correct regulated output voltage.

The Error Amplifier consists of Q12 and Q14, which are connected as a comparator. The output at the collector of Q14 indicates any voltage variations which occur at the base of Q14 relative to the fixed voltage at the base of Q12. Zener diode D10 maintains a fixed 9-volt drop, setting the base of Q12 at about -9 volts. The base level of Q14 is determined by the voltage divider network R18-R19-R20-R21-R23. R23, the -100 Volts adjustment, allows the operating point of the Error Amplifier to be adjusted to set the output voltage of the supply at -100 volts. R13 is the emitter resistor for both comparator transistors and the current through it divides between Q12 and Q14. The output current of the Error Amplifier stage controls the conduction of the Series Regulator stage. This is accomplished as follows: Assume that the output voltage increases (becomes more negative) because of a change in load or an increase in line voltage. This negative-going voltage change at the output is applied to the base of Q14, reducing the conduction of Q14. As current through Q14 is reduced, Q24 base current increases. This results in increased Q24 collector current, increasing the voltage drop across R25 and R26 and pulling the base of Q28 negative. The emitter of Q28 follows the base; hence, the base of Q32 is also pulled negative. Reduced current through Series Regulator Q32 decreases current through the load, causing the output voltage to decrease (become less negative) to its correct level. These changes occur rapidly, and the effect is to maintain unchanged output voltage. In a similar manner, the Series Regulator and Error Amplifier stages compensate for output changes due to ripple. As will be seen in subsequent paragraphs, R33 determines the limit current for the Series Regulator stage, and thus for the load. Transients beyond the frequency range of the regulator are filtered by C31 to prevent their appearance on the output voltage.

When the power switch is activated, diode D25 provides a base current path for Q28, allowing the -100-Volt Supply to turn on first, since all the other supplies are dependent upon its output. As the -100-Volt Supply output builds up to its correct level, D25 is reverse biased and remains off during normal operation of the instrument.

The Short-Protection Amplifier stage, Q30, protects the -100-Volt Supply if the output is shorted, and also serves to limit the current demanded from the Series Regulator under excessive load. During normal operation, divider R30-R31 sets the base of Q30 to a point below the turn-on level of the transistor. When excess current is demanded from Series Regulator Q32 due to an overload or short circuit, the additional current through R33 raises the emitter of Q32 more positive. This produces a corresponding change at the base of Q32, which is connected through R30

(A)

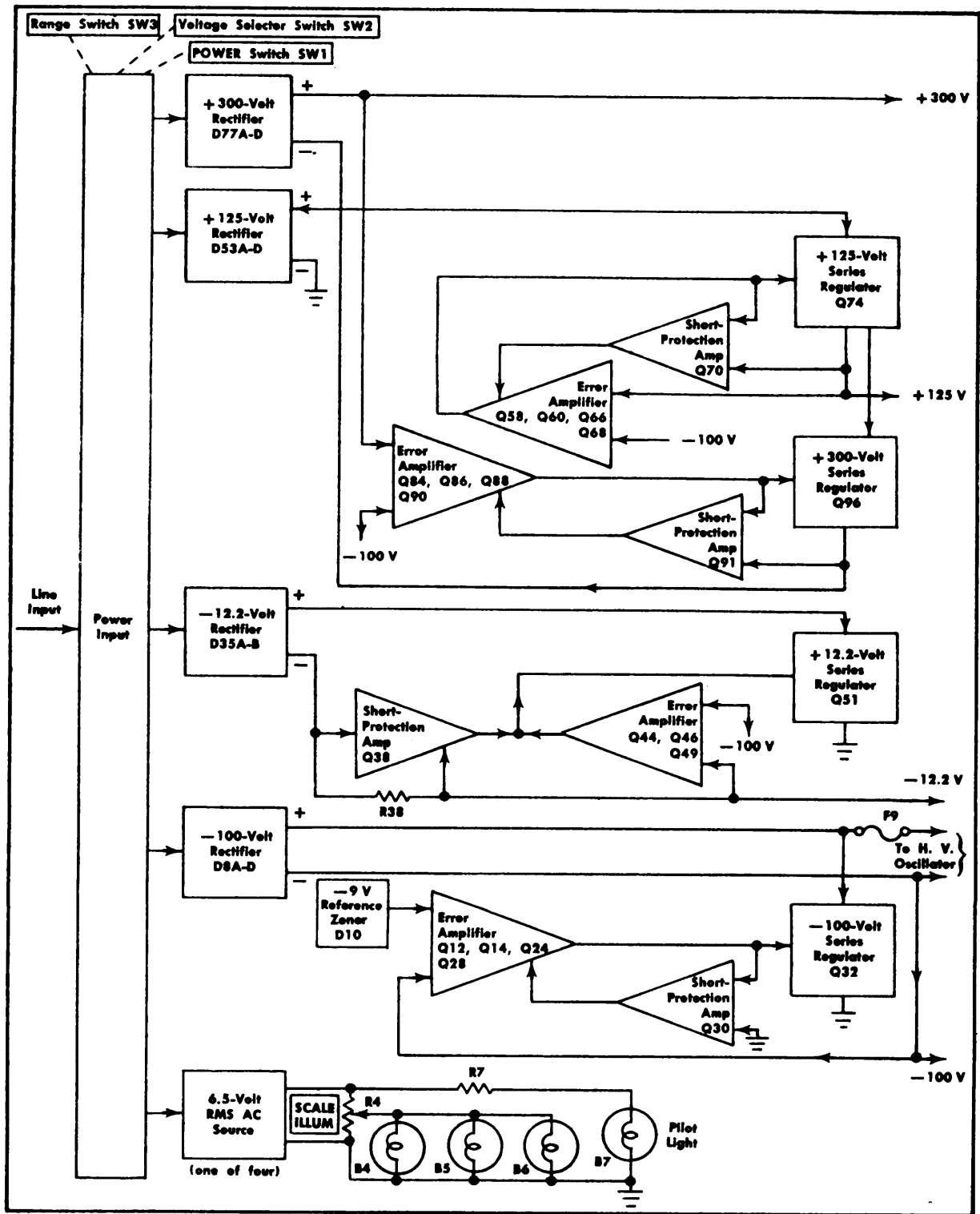

Fig. 3-1. Power Supply detailed block diagram.

to the base of Q30. This positive-going change biases Q30 into conduction. As a result, less current is available to Q28, to Q32 and to the load, thus causing the supply to lose regulation. R31 senses the decrease in load voltage and adds to increasing base current of Q30. As the collector of Q30 goes negative, conduction of Q28 and Q32 is further decreased. Thus the output current is decreased and remains low until the excessive load is removed. D19, together with divider R18-R19-R20, provides protection to the --12.2-Volt supply in the event the -100-Volt Supply is shorted to the -12.2-Volt Supply by causing the -100-Volt Supply to lose regulation, and therefore lose reference voltage for the -12.2-Volt Supply. D31 protects the -100-Volt Supply from damaging polarity reversal if it is shorted to either the +125-Volt Supply or the +300-Volt Supply.

- 12.2-Volt Supply

Rectified voltage for operation of the -12.2-Volt Supply is provided by D35A-B, filtered by C36 and applied to the -12.2-Volt Supply Series Regulator stage. Reference voltage for this supply is provided by voltage divider R42-R43 between the regulated -100-Volt Supply and ground. If the -12.2-volt output changes, a sample of the change appears at the base of Q46 as an error signal. Regulation of the output voltage is controlled by Error Amplifier Q44-Q46-Q49 and Series Regulator Q51 in a manner similar to that described for the -100-Volt Supply. Transients beyond the frequency range of the regulator are filtered by C47.

Short protection is provided by Q38 and R38. For normal operation, the emitter-base voltage of Q38 is not enough to bias it into conduction. However, when the output is shorted, the high current demanded from the -12.2-Volt Supply is drawn through R38, producing a voltage drop sufficient to forward bias Q38. Q38 collector current then produces an increased voltage drop across R40, reducing the conduction of both Q49 and Q51 to limit the output current. R39 protects Q38 from sudden current surges by limiting the base current. D47 protects the -12.2-Volt Supply from damage if it is shorted to either the +125-Volt Supply or the +300-Volt Supply.

+ 125-Volt Supply

Rectified voltage for operation of the +125-Volt Supply is provided by D53A-D, filtered by C54 and applied to the +125-Volt Supply Series Regulator stage. The +125-volt output is summed with the -100-volt reference through divider R62-R63, and the summation is applied through R61 to the base of Q60 and compared to the grounded base of Q58. If the +125-volt output changes, a sample of the change appears at the base of Q60 as an error signal. Regulation of the output voltage is controlled by Error Amplifier Q58-Q60-Q66-Q68 and Series Regulator Q74 in a manner similar to that described for the -100-Volt Supply. Transients beyond the frequency range of the regulator are filtered by C97B-C to prevent their appearance on the output voltage.

Short protection for this supply is provided by the Short-Protection amplifier stage, Q70, which functions in a manner similar to that described for Q30 in the --10Volt Supply. D62 protects the Error Amplifier from damage if the output of the +125-Volt Supply collapses or goes negative, causing C62 to

rapidly discharge and reverse bias Q60. Diode D75 protects electrolytic capacitor C97B-C and the transistors in the circuit from damaging polarity reversals in the event the +300-volt output is shored to ground or to one of the negative supplies. D76 causes the +125-Volt Supply to go into current limiting when the +300-Volt Supply is shorted to ground or to one of the negative supplies.

+ 300-Volt Supply

Rectified voltage for operation of the +300-Volt Supply is provided by D77A-D, filtered by C78 and applied from the negative side of the rectifier to the +300-Volt Supply Series Regulator stage. The +300-volt output is summed with the -100-volt reference through divider R80-R81, and the summation is applied through R83 to base of Q84 and compared to the grounded base of Q86. If the +300-volt output changes, a sample of the change appears at the base of Q84 as an error signal. Regulation of the output voltage is controlled by Error Amplifier Q84-Q86-Q88-Q90 and Series Regulator Q96 in a manner similar to that described for the -100-Volt Supply. Transients beyond the frequency range of the regulator are filtered by C97A. The load current through Series Regulator Q96 also passes through the +125-Volt Supply Series Regulator, Q74. However, this does not affect the limit current of the +125-Volt Supply.

Shorting protection for this supply is provided by the Short-Protection Amplifier stage, Q91, which functions in a manner similar to that described for Q30 in the -100-Volt Supply. D80 protects the Error Amplifier from damage if the output of the +300-Volt Supply collapses or goes negative, and D95 protects the transistors in the circuit from damaging polarity reversals in the event the +125-Volt Supply is shorted to ground or to one of the negative supplies.

6.5-Volt RMS AC Source

The four 6.5-volt RMS secondary windings of T1 provide power for the CRT heater, the plug-in heaters via J11 and J21, the pilot light, B7, and the scale illumination lights, B4, B5, and B6. Current through the scale illumination lights is controlled by the SCALE ILLUM control, R4, to change the brightness of the graticule lines.

DEFLECTION CIRCUITS

horizontal and vertical signals for deflecting the CRT beam are received through pins 17 and 21 of each plug-in unit and applied to the respective deflection plates of the CRT. The effective deflection circuit capacitance encountered by each of these signals at the plug-in connector affects the bandwidth and phase shift of the plug-in unit. Compensating capacitors C102 and C109 (shown on the Plug-In Connectors diagram) are factory-adjusted to set the effective capacitance at a standard value of 14.3 picofarads to ensure plug-in compatibility.

1 kHz CALIBRATOR

General

The 1 kHz Calibrator circuit produces a square-wave output with accurate amplitude and frequency. This output is available as a square-wave voltage at the CAL OUT connector or as a square-wave current through the 10 mA probe current

Circuit Description--Type R561B

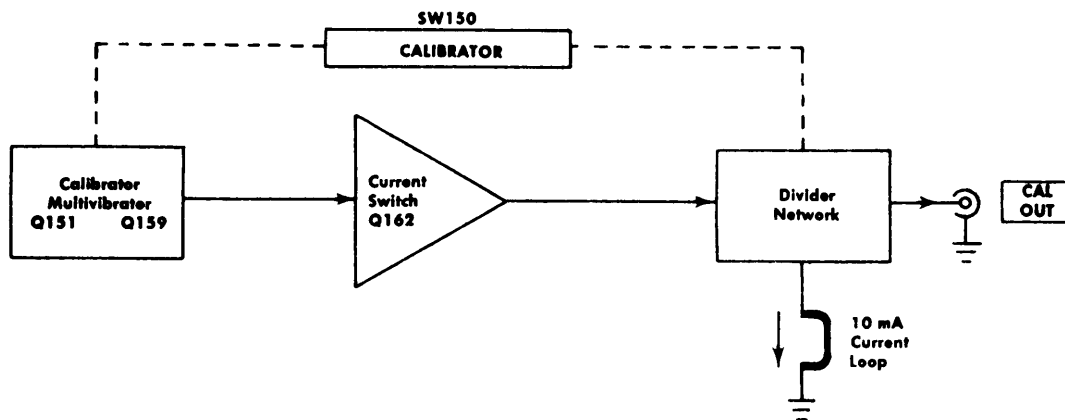

Fig. 3-2. 1 kHz Calibrator detailed block diagram.

loop. An accurate +40 volts DC level is also available. The CALIBRATOR switch selects the attenuation of the output signal to provide square-wave voltage outputs between 40 volts and 4 millivolts (between 0.2 volts and 2 millivolts into 50 ohms) peak to peak. Fig. 3-2 shows a detailed block diagram of the 1 kHz Calibrator circuit.

Calibrator Multivibrator

The Calibrator Multivibrator is comprised of Q151 and Q159, and is a free-running emitter-coupled multivibrator. The circuit operates in a symmetrical manner and the output is an accurate one-kilohertz square wave. Only an approximate 9-volt change is exhibited at the emitters of Q151 and Q159, so that an essentially constant current of about 0.8 mA is maintained through resistors R150 and R158.

Refer to the wave shapes shown in Fig. 3-3 for this discussion. With the CALIBRATOR switch, SW150, in all positions except 1 mA DC and OFF, the emitters of Q151 and Q159 are returned to the +125-volt supply through D151-R150 and D159-R158. Assume that the multivibrator has just switched states; Q151 is off and Q159 is on. This is T_0 in Fig. 3-3. The base potential of Q159 is set to about -11.0 volts by voltage divider R153-R154-R156 to ensure that Q159 will not saturate. The voltage at the anode of D159 is about -9.8 volts because of the voltage drop across two forward biased junctions. Capacitor C157 had about a 2-volt charge as switching occurred; thus, the voltage at the anode of D151 is about -7.8 volts, cutting off Q151. C157 begins to charge toward the +125-volt supply via R150. Total current through Q159 is about 1.6 mA; 0.8 mA through R158 and 0.8 mA through C157 and R150.

After about 0.5 milliseconds (corresponding with T_1 in Fig. 3-3), C157 has charged to the turn-on level of Q151 and D151. At this point, the capacitor has a charge of about 11 volts and the potential at the anode of D151 is about +1.2 volts. The capacitor charging current through Q159 ceases as Q151 and D151 begin

to conduct. As the collector of Q151 (hence the base of Q159) rises, Q159 and D159 are switched off and C157 begins to discharge through R158. The C157-R158 current sums with R150 current through Q151, producing an approximate 9-volt positive-going step at the base of Q159.

C157 continues to discharge, and after 0.5 milliseconds (T_2 in Fig. 3-3), the voltage at the anode of D159 has risen to forward-bias Q159 and D159. As Q159 begins to conduct, the anode of D159 is clamped at about 0.8 volts and discharge action of C157 is halted. The current through Q151 decreases, causing its collector to introduce a negative-going step, which is connected through the Q159 base-emitter junction and D159 to C157. Because C157 cannot obtain an instantaneous charge, the anode of D151 is pulled negative to reverse bias D151 and Q151. Q151 turns off, and its collector falls rapidly to about -11.0 volts, resulting in an approximate 9-volt negative-going step applied through Q159 and D159 to C157. The anode of D151 is pulled down to about -7.8 volts, completing the cycle.

The Calibrator Multivibrator circuit has been designed to repeat the preceding sequence at an accurate one-kilohertz frequency. However, since a tolerance range of the passive components does exist, the frequency can be adjusted by varying slightly the amplitude across C157 during the charge-discharge cycle. This is accomplished by adjustment of R154, Frequency, which determines the potential on D159 anode at the instant the diode turns on. For example, with greater amplitude, longer charge and discharge times are required, thus lowering the frequency.

Output Stage

The output stage consists of the Current Switch, Q162, and the Divider Network. During the half cycle that Q159 is conducting, current is injected into the base of Q162. Q162 saturates and its collector drops to about -12 volts, reverse biasing D168. With D18 off, there is no current through R170 and R171, and the output level at the cathode of D168 drops to zero volts.

(A)

When Q159 turns off, Q162 turns off and D161 turns on to protect the Q162 base-emitter junction from reverse-bias breakdown. D164 and D168 turn on, and the output of the circuit (at D168 cathode) is dependent upon voltage divider R166-R167-R170-R171 between +125 volts and ground. This output level is set to exactly +40 volts by adjustment of R166, Amplitude. When this adjustment is made, the current through the divider is an accurate 10 mA, which is available at the current probe loop in the 10 mA positions of the CALIBRATOR switch.

The signal voltage available at the CAL OUT connector is determined by the divider network (made up of precision resistors) and the setting of the CALIBRATOR switch. In the 10 mA DC (40 VDC) position, the Calibrator Multivibrator is inoperative so that a +40-volt DC output level is produced. R173 is placed in series with the R166-R167-R170-R171 resistance to obtain an effective resistance of 450 ohms with 4 volts applied, as seen by the CAL OUT connector in the 4 V position of the switch. This effective resistance becomes part of the output voltage divider in the positions of 0.4 V and below (these positions have an accurate 50-ohm output resistance, which when terminated by 50 ohms can further divide the outputs by two, providing outputs of 0.2V, 20 mV and 2 mV). In the 10 mA position, the CAL OUT connector is grounded.

R183, which is about ten times the resistance of the braid of a 42-inch coaxial cable, cancels any ground loop current that may exist between the CAL OUT connector and some other instrument chassis.

CRT CIRCUIT

General

The CRT Circuit provides the high voltage and control circuits necessary for operation of the cathode-ray tube (CRT). Fig. 3-4 shows a detailed block diagram of the CRT Circuit.

High Voltage Oscillator

Q219 and its associated circuitry comprise a class C oscillator to provide the drive for the high-voltage transformer, T220. When the instrument is turned on, conduction of Q214 provides a base current path for Q219. The collector current of Q219 increases and a voltage is developed across the collector winding of T220. This produces a corresponding voltage increase in the feedback winding of T220 which is connected to the base of Q219, causing it to conduct harder. While Q219 is conducting, C217 charges negatively to the peak to peak voltage of the feed-back winding. Eventually the rate of collector current increase in Q219 becomes less than that required to maintain the voltage across the collector winding and the voltage drops. This turns off Q219 by way of feedback voltage to the base. During the interval that Q219 is not conducting, the negative charge on C217 is partially removed through Q214. Q219 remains off until the feedback voltage on the base is near the peak positive value again. The cycle repeats at a frequency of 40 to 50 kilohertz. The amplitude of sustained oscillation depends upon the average current delivered to the base of Q219, and finally, the average Q219 collector current.

(A)

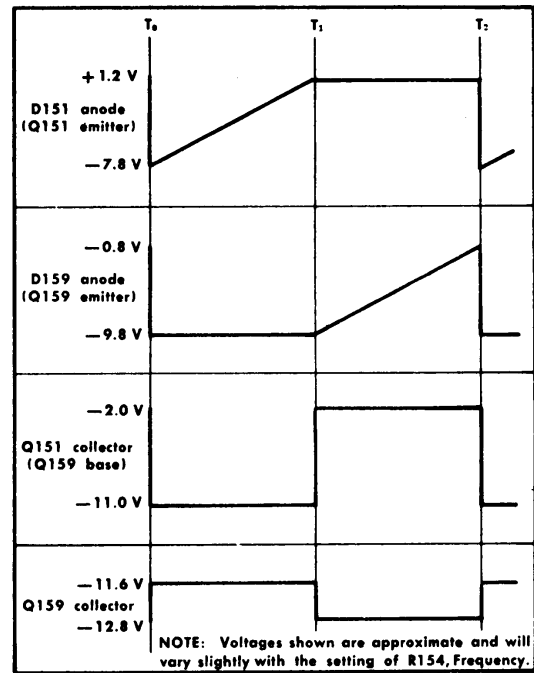

Fig. 3-3. Calibrator Multivibrator waveforms.

High Voltage Regulator

Feedback from the secondary of T220 and +125 volts is summed through the voltage divider network consisting of R200, R201, R206, R208 and R233 through R238, and the difference is applied to the gate of Field-Effect Transistor Q211.. This sample of the output voltage is compared to the regulated --12.2-volt level at the source of Q211. It is then inverted and amplified by Q211 and applied to the base of Q214. Amplitude of the oscillations at the collector of Q219 is determined by the average collector current of Q214.

Regulation. is accomplished as follows: If the output voltage at the -330Q V test point starts to go positive (becomes less negative), a sample of this positive-going voltage is applied to the gate of Q211. Conduction of Q211 is increased, and as its drain goes negative because of the voltage dropped across R211, the base current of Q214 is increased. An increase in conduction of Q214 increases the average collector current, which is applied through the feedback winding of T220 to the base of Q219. Q219 conducts harder, increasing the collector current to produce a larger induced voltage in the secondary of T220. This increased voltage appears as more negative voltage at the -3300 V test point to correct the original positive-going change. By sampling the output from the cathode supply in this manner, the total output of the high-voltage supply is held constant.

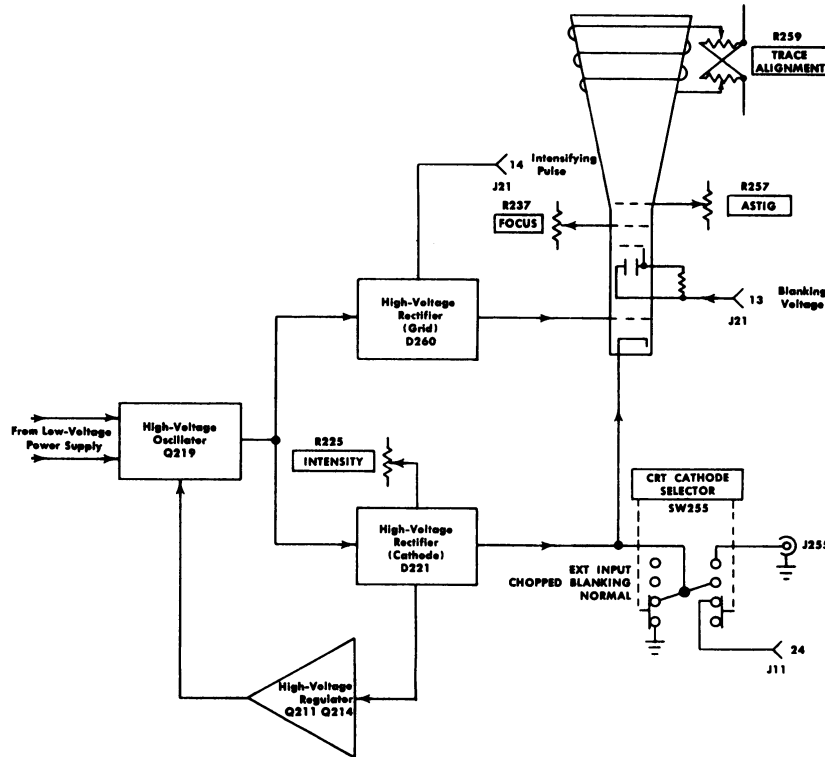

Fig. 3-4. CRT Circuit detailed block diagram.

Output voltage level of the high-voltage supply is controlled by the High Voltage adjustment, R206, in the gate circuit of Q211. This adjustment sets the effective divider ratio, which in turn determines the voltage necessary to satisfy the quiescent condition of Q214 and Q219 in the manner described for a change in output voltage. Neon bulb B209 and diode D212 protect the FET, Q211, from damage due to excessive voltage.

High Voltage Rectifiers and Output

The high-voltage transformer, T220, has two output windings. These windings provide the negative CRT cathode potential and the CRT control grid bias.

The accelerating potential for the CRT cathode is supplied by the half-wave rectifier D221 and held constant by the High-Voltage Regulator stage in the primary of T220. The output level is adjustable to about -3300 volts on the cathode by the High Voltage adjustment mentioned previously. (The 6.5-volt CRT cathode heater is also elevated to the cathode potential through R246.)

Half-wave rectifier D260 provides a negative voltage for the control grid. The voltage applied to-the-control-grid is determined by the setting of the INTENSITY control (to be

discussed in the next paragraph), the CRT Grid Bias control (R269) and any intensification signals received from the time-base plug-in unit (delayed sweep and sampling units only). Reference to ground for this supply is set by the conduction of D272.

Beam current is controlled by R225, INTENSITY. As the control is rotated clockwise, the wiper arm moves toward -100 volts. This more negative DC reference voltage is applied to the secondary winding controlling the CRT cathode, reducing the voltage demanded of the winding to maintain -3300 volts at the -3300 V test point. This is accomplished by the regulator circuit. The voltage across the grid winding is also reduced, which results in a more positive voltage applied to the CRT control grid, thus increasing beam current. Beam current is reduced in a like manner by rotating R225 counterclockwise.

Neon bulbs B277, B278 and B279 provide protection to the CRT if the voltage difference between the control grid and the cathode exceeds about 135 volts.

CRT Control Circuits

In addition to the INTENSITY control discussed previously, the FOCUS and ASTIGMATISM controls have been incorporated for arriving at the optimum CRT display. FOCUS control R237 provides the correct voltage for the second anode in the CRT. Proper voltage for the third anode is obtained by adjusting ASTIGMATISM control R257. In order to obtain optimum spot size and shape, both the FOCUS and ASTIGMATISM controls are adjusted to provide the proper electrostatic lens configuration in the CRT. The TRACE ALIGNMENT control, R259, permits adjustment of the DC current through beam-rotation coil L259 to align the display with the horizontal graticule lines. The Geometry adjustment, R256, controls the overall geometry of the display.

Blanking

The CRT beam is blanked by a special set of deflection plates in the CRT. One of the plates (pin 7) is connected directly to the +125-volt supply. The second plate (pin 6) is connected through plug-in connector J21 to the horizontal plug-in unit. When there is no sweep, a quiescent voltage is

applied from the horizontal unit to create a difference of potential between the two plates. This voltage can either be positive or negative with respect to the +125 volts on the other plate. The potential difference created is sufficient to deflect the CRT beam so that it is absorbed in the deflection structure and does not reach the screen.

The CRT beam is unblanked whenever the two deflection plate voltages become equal. For example, if a sweep occurs or if the horizontal plug-in unit is removed, the voltages are made equal and the beam is allowed to pass through to the CRT screen. Sweep unblanking is produced by either a positive or negative gate pulse (depending on the quiescent level) applied to pin 6, equaling the +125 volts normally present at pin 7. In a like manner, when the horizontal plug-in unit is removed, the two deflection plates are equalized through R244 at +125 volts.

Intensity Modulation

The intensity of the CRT display may be modulated by applying signals to either the grid or the cathode of the CRT.

Intensifying signals from a delayed sweep time-base plug-in unit are applied to the grid supply via pin 14 of the horizontal plug-in interconnecting socket, J21. These signals brighten the delayed-sweep portion of the delaying-sweep display. When the time-base unit is set to Intensified, the control grid supply is referred to a negative voltage in the intensifying circuit through D275, reducing the overall display intensity. At this time, D272 is reverse biased by the negative voltage at the juncture of the two diodes. Intensification results when the positive-going pulse from the time-base unit reverse biases D275 and the grid supply is referred to ground through D272 (as for normal operation). The positive-going pulse is then coupled through R275 and C275 to the CRT control grid. Thus the brightened portion of the display is the same intensity as a normal display and the background trace is dimmed.

External modulating signals may also be applied to the CRT by way of the cathode, through the rear-panel EXT INPUT connector, J255, and the CRT CATHODE SELECTOR, SW255. With the INTENSITY control adjusted properly, a positive or negative pulse between 3 and 50 volts in amplitude will produce dimming or intensification of the CRT beam.

When a multi-channel vertical plug-in amplifier that provides dual-trace chopped blanking pulses is used, the blanking pulses are applied via the interconnecting socket J11 and the CRT CATHODE SELECTOR to the CRT cathode circuit. These pulses are about 5 volts in amplitude, and at normal intensity levels are sufficient to cut off the CRT beam during the time the amplifier channels in the vertical plug-in unit are being switched.

(A)

SECTION 4
MAINTENANCE R561A

PREVENTIVE MAINTENANCE

Cleaning

Occasionally blow the dust out of the instrument with a low-velocity dry air stream. Remove persistent dirt with a small paint brush or damp cloth. The screen on the fan can be snapped out and should be cleaned as needed. Check it frequently.

Fan Oiling

The fan should be oiled with a few drops of oil about every six months. An industrial hypodermic syringe and needle is used to insert oil through a protective rubber cap located under the fan label. The oil recommended is Anderol L826 from the Lehigh Company or Rotron distributors, but if not available, a good light machine oil may be used. If a syringe and needle cannot be obtained locally, you can order them through the NICP by specifying Hypodermic Syringe, Tektronix Part No. 003-282 and Hypodermic Needle, Tektronix Part No. 003-285.

Fig. 4-1 shows how to oil the fan. Place the needle at the point on the label shown in Fig. 4-1. With the needle at about 45°, pierce the label and rubber cap (located under the label); insert the needle about 1/4" and depress the syringe-plunger to inject a few drops of oil.

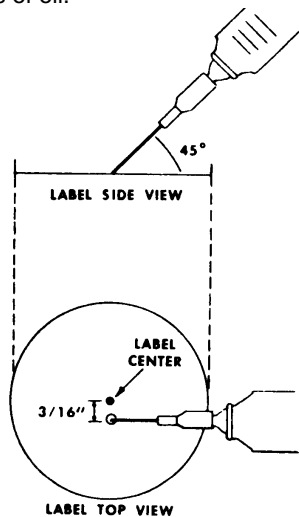

Fig. 4-1. Fan motor oiling with hypodermic

(A)(A)

CORRECTIVE MAINTENANCE

Replacing Parts

Most parts in the Type RM561A Oscilloscope can be replaced without detailed instructions. Some parts, however, should be replaced by using definite procedures. These procedures are described in the following paragraphs.

A replaced part may affect instrument calibration. Check and adjust where needed.

Soldering Precautions and Procedure

In Tektronix instruments, parts are connected to ceramic terminal strip notches with solder containing about 3% silver. The bond between the notch and ceramic strip may be broken by repeated use of ordinary 60/40 tin-lead solder or by excessive heat. Therefore, when resoldering parts to a ceramic strip use solder containing 3% silver and do not overheat the work. Occasional use of ordinary solder, however, will not break the bond. Usually 3% silver solder is available locally; or one-pound rolls may be ordered from the NICP.

The following soldering procedure may be used to remove and replace parts on a ceramic terminal strip.

1. Use 50-to-70-watt soldering iron with a wedge shaped tip. (With this type tip you can heat the solder slot without overheating the strip.)
2. Tin the soldering iron tip with silver-bearing solder.
3. Heat the parts soldered to the ceramic strip only enough to make the solder flow freely. Do this by touching one corner of the soldering iron tip to the notch. (Be careful: excessive pressure will break the ceramic strip.)
4. When you remove a part, pull its lead out of the notch while the solder is hot.
5. When you replace a part use only enough solder to cover the wires and form a small fillet in the notch.
6. Clip excess leads of parts replaced and be sure to remove all clippings from the instrument.

Replacing Ceramic Terminal Strips

Damaged ceramic terminal strips can be replaced by the following procedure. Fig. 4-2 shows how ceramic strip parts are assembled.

1. Unsolder all connections to damaged ceramic strip.
2. Cut off one side of each plastic yoke holding the old ceramic strip.
3. Remove old ceramic strip.
4. Remove remainder of old yokes from spacers.

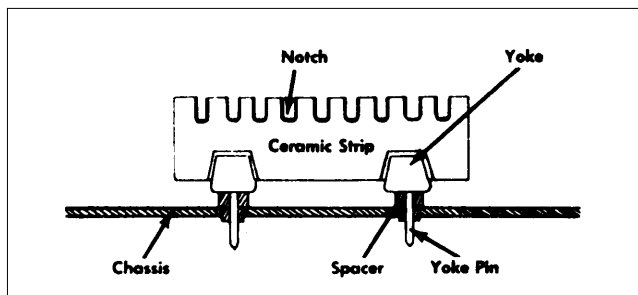

Fig. 4-2. Ceramic terminal strip assembly.

5. Replace old spacers with new ones. (If not damaged, spacers can be reused.)
6. Set new ceramic strip yoke pins into spacers.
7. Drive new yoke pins completely into spacers by pressing or lightly tapping the ceramic strip directly above the yokes. Be careful, don't break strips.
8. Cut off portion of new yoke pins protruding through spacers on side of chassis opposite the ceramic strip.
9. Resolder connections to new ceramic strip using the information headed Soldering Precautions and Procedure.

Replacing Calibrator Switch

The entire switch should be replaced and can be ordered either wired or unwired.

Cathode-Ray Tube

WARNING

When replacing crt, wear a plastic face mask and protective gloves for protection in case tube implodes.

To remove the cathode-ray tube, disconnect the four leads connected to the neck of the tube, the tube socket, and loosen the tube clamp on tube base. Remove the crt bezel, light reflector and light shield. Pull the crt straight out through the front panel, being careful not to bend or break the crt neck pins. The rubber gasket and implosion shield can be removed from the crt face after it is out of the instrument.

Install the new crt by the reverse of the preceding procedure. When replacing the implosion shield be sure that the notched side is down. Follow the color-code information on the tube shield when the crt neck pin leads are replaced. When the crt is properly installed, the back of its faceplate is flush with the instrument front panel.

Correct position of the shield extension, grounding strip and Mylar sleeve is important when re-installing the crt. Replace these components on the positions shown in Fig. 4-3. Note that the gap between the ends of the shield extension

falls directly under the grounding strip. Tighten the base clamp screw.

After the crt is replaced, it may be necessary to adjust the TRACE ALIGNMENT and HIGH VOLTAGE controls and the deflection-circuit capacitance (C760 and C761) according to the calibration procedure. Also check the calibration of time-base and amplifier plug-in units.

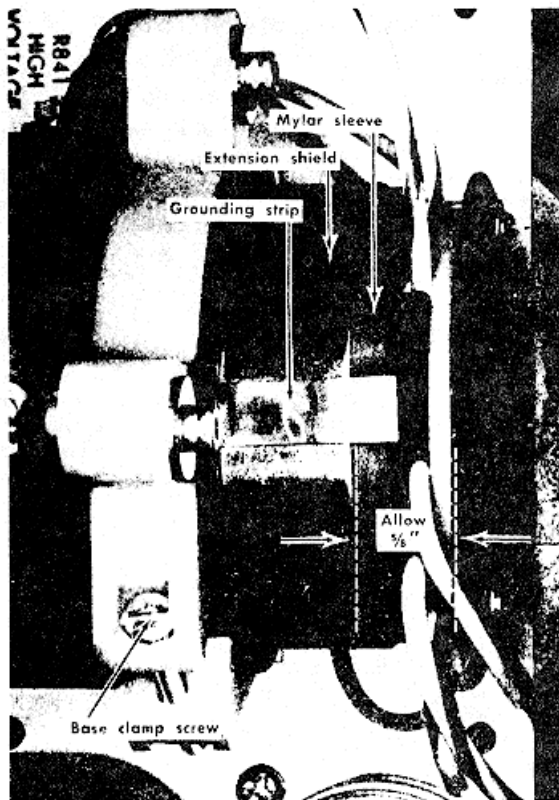

Fig. 4-3. Correct position of shield extension and Mylar sleeve.

TROUBLESHOOTING

If trouble occurs in the Type RM561A Oscilloscope, a five-step procedure may be used for repair. First, confirm the trouble. Next, isolate trouble to a plug-in unit or to the Type RM561A. Localize a trouble in the Type RM561A to the Power Supply, Crt Circuit, or Calibrator. Troubleshoot the correct circuit to find the defective parts. Replace defective parts.

Confirmation of Trouble

Improper control settings may at times give indications of trouble. Therefore, you should be sure that the apparent trouble is not caused by improper front panel control settings. For example, an improper setting of the SOURCE or COUPLING switch on a time-base unit can cause apparent triggering troubles: an improper setting of the VARIABLE

(A)(A)

control on an amplifier unit can cause an apparent decrease in sensitivity.

When a trouble exists, it must be isolated to one of the plug-in units or to the Type RM561A indicator.

Isolating Trouble

Isolating trouble to a plug-in unit or to the indicator can be done in one of two ways, depending on whether or not there are spare plug-in units available.

If trouble is found to be in the plug-in unit, refer to the instruction manual for that unit. A plug-in extension (Part Number 013-034, available through the NICP) allows the units to be operated while extended out through the front of the plug-in opening.

Spare Plug-In Units Available

If more than two plug-in units are available, the easiest way to isolate trouble is to replace the plug-in units one at a time. The faulty unit can then be isolated by noting when proper operation is restored. If plug-in replacement

does not correct the trouble, the Type RM561A is probably faulty.

NOTE

A non-sampling plug-in unit cannot be operated with a sampling plug-in unit.

Spare Plug-In Units Not Available

When spare plug-in units are not available, the crt display will be of great help. Trouble will normally show up as an erroneous display, or as no display at all. Since the crt display will help isolate the trouble, the following procedure is divided according to the type of display.

No Trace Or Spot. If no trace can be obtained on the crt, remove both plug-in units and vary the INTENSITY control. A spot should appear. If no spot appears, the trouble is in the Type RM561A. If a spot does appear when both plug-in units are removed reinsert each unit separately. After warm up, vary its POSITION control. If the spot or trace cannot be returned to the approximate center of the crt when a single plug-in unit is in the indicator, the trouble

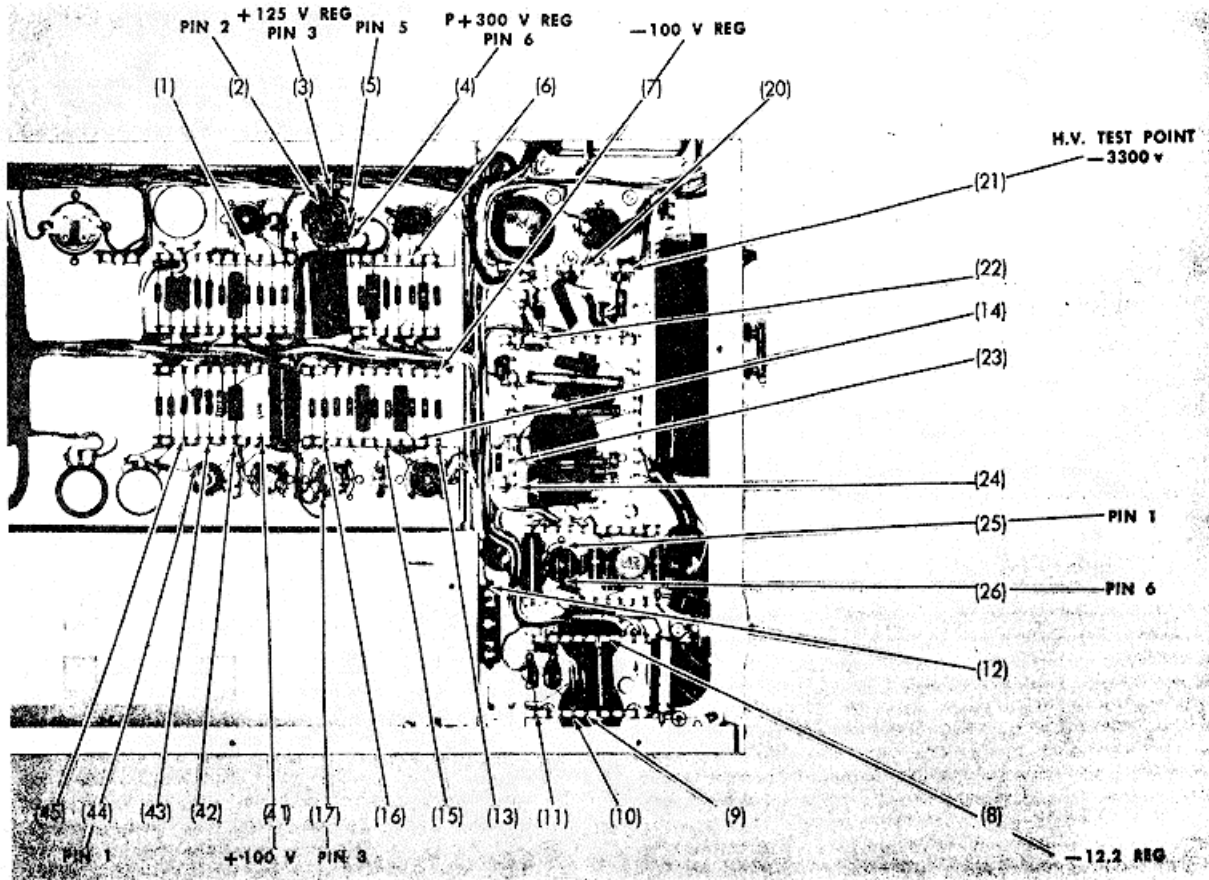

Fig. 4-4. Power-Supply test points (1) through (17). CRT Circuit test points, (20) through (26). Calibrator test points (4) through (45).

Maintenance—Type RM561A

is probably in that unit. (if a lime-base unit is installed, be sure it is set for free-running operation to unblank the crt.)

Insufficient Vertical Deflection or Improper Sweep Timing. If the plug in unit front-panel gain controls do not permit adequate vertical deflection or proper sweep timing, check the low-voltage and high-voltage power supply voltages (see schematics).

If the power-supply voltages are not correct, remove both plug-in units and check the voltages again. If they still are not correct, the trouble is in the Type RM561A indicator. If the power-supply voltages are correct with both plug-in units removed, but incorrect with only one of the two inserted, the trouble is in that unit. If the power-supply voltages are correct with both plug-in units removed, but incorrect when either is inserted, the trouble is probably the power supply of the Type RM561A.

Improper Triggering. If external triggering and line triggering are satisfactory, but internal triggering is not, the trouble is probably in the Trigger Pick-off Circuit of the amplifier plug-in units. If satisfactory triggering cannot be obtained from any of the three sources external, internal or line) the trouble is probably in the time-base plug-in unit.

Waveform Distortion. If there is any waveform distortion, but no other indications of malfunction (such, as improper sweep timing) the trouble is probably in the vertical plug-in unit

Localizing Trouble In Type RM561A Indicator

If it has been determined that trouble exists in the Type RM561A, the location of the trouble can be further localized to the Power Supply, the Crt Circuit, or the Calibrator.

To localize the trouble to either the Power Supply or the Crt Circuit, measure the output of each of the regulated power supplies. If incorrect supplies are measured, the trouble is in the Power Supply or the power source. If all of the measured voltages are proper, the trouble is in the Crt Circuit.

Trouble in the Calibrator is indicated by an erroneous output at the CAL. OUT connector.

When it is known which circuit contains the trouble, that circuit can be checked to isolate the defective component

Circuit Troubleshooting

In troubleshooting a circuit, broken wires, worn switches, scorched parts, and improperly seated tubes can be found by visual inspection. (Before a scorched part is replaced the cause of the scorching should be eliminated.)

Tube failure is the most prevalent cause of trouble in Tektronix instruments. Therefore, if a visual check fails to reveal the cause of trouble, oil tubes should be checked as the next step. Tubes should be checked by substitution, one at a time. (Tube-testers cannot adequately check all parameters.) Be sure to return all good tubes to their original sockets; otherwise the instrument may have to be recalibrated unnecessarily because of different characteristics of the same tube type. If tube substitution does not correct the trouble, then check the rest of the circuit by voltage and resistance measurements. Voltages at various test points throughout the instrument are indicated on the schematics. The test points can easily be located using Fig. 4-4. The voltages at the test points are typical and may vary considerably from instrument to instrument. Resistance measurements in a circuit will usually be point-to-point checks for which the proper values can be approximated from the schematic diagrams. Table 4-1 may be used as an aid in relating trouble symptoms to the probable cause and the procedure to use to locate the defective component. Voltages listed in the table were obtained with the Type RM561A operated without plug-in units.

All signal wiring in the Type RM561A is colored to make Circuit tracing easier. In addition, all regulated power supply leads are color coded to follow the standard EIA code. The first color (widest stripe) indicates the first number of the voltage. The second color indicates the second and the third color (smallest stripe) indicates the multiplier. The voltage is positive if the main color of the wire is white and negative if the main color of the wire is tan. Four colors would be required to indicate all the digits plus a multiplier for the 4-125-volt leads. To avoid this, the +125-volt leads are coded as +120; that is, brown, red, brown on a white base. A -100-volt lead is coded brown, black, brown on a tan base while +300-volt leads are coded orange, black, brown on white

The switch wafer shown on the Calibrator diagram is coded. The letters F and R indicate whether the front or rear of the wafer is used to perform the particular switching function.

Table 4-1.	
RM561A Troubleshooting Table	
Symptoms	Checks
- 100 Volt Supply (Any change in this supply may change instrument calibration).	
1. Incorrect output level, ripple, or regulation.	a. Check line voltage. b. Check Setting of - 100 volts adjustment (see Calibration Procedure). c. Check V609, V634, V627 and Q624 by substitution. d. If output still incorrect go to whichever symptoms apply of 2 through 7.
2. Output voltage high (too negative).	b. Measure V634 bias, between pin 7 of V609 and pin 8 of V634; about 2 v. Use meter that can be elevated. (If bias is excessive check R618 and R616). c. Check R618, R616, R634, R633, and R624.

Symptoms	Checks
3. Output voltage low (too positive).	a. Check voltage between pins 17 and 18 of T601. 137 vac \pm 10% check T601 primary circuit). b. Check voltage between C640A terminals: about 175 vdc \pm 10%. (Incorrect: check C640A, C640B, R640, and D640). c. Check test point (14): about -80 vdc. (Incorrect: check V609). d. Check R617, R616, C616, C640B.
4. Poor regulation at either high, low or normal line voltage. (Supply should hold regulation within \pm 1% throughout normal line voltage range).	a. Check for correct output voltage before checking regulation - also, check output voltage after regulation trouble is fixed. b. Check voltage at test point (17): about +85 vdc. (Voltage low: check D660 and do checks 2A, 2B, and 2C). c. Check for excessive loading by either plug-in unit or RM561A circuits.
5. Poor regulation at low line voltage.	Check R635, R628 and shunt resistors in plug-in unit.
6. Poor regulation at high line voltage.	Substitute another plug-in unit. (Symptom occurs if load is reduced while shunt resistor remains the same in plug-in unit).
7. Excessive ripple.	a. Check for correct output voltage and regulation before checking ripple - also check output voltage and regulation after ripple trouble is fixed. b. Check voltage at test point (17): about +85 vdc. c. Check ripple at test point (17): should be less than 25 v peak-to-peak with load. (Excessive: check C640A and D640). d. Check tubes. e. Check C616, C611, C640A and C640B.
+125-Volt Supply (Any change in this supply may change instrument calibration).	
8. Incorrect output level, ripple, or regulation.	a. Check line voltage. b. Check -100 volt supply output test point (7). c. Check setting of -12.2 VOLTS adjustment (see Calibration Procedure). d. Check V654, V667. e. If output still incorrect go to whatever symptoms apply of steps 9 through 14.
9. Output voltage high.	a. Check voltage at test point (1): about +68 vdc. (Incorrect: check R657, R658, and V654). b. Check R650.
10. Output voltage low.	a. Check voltage between pins 19 and 20 of T601: 160 vac +10%. (Incorrect: check primary circuit).

Symptoms	Checks
	b. Check voltage at test point (2): +215 vdc. (Incorrect: check C642A, R642, D642). c. Check test point (1): about +68 vdc. (Incorrect: check R659, V654). d. Check C650, R651.
11. Poor regulation at either high, low, or normal line voltage range).	a. Check for correct output voltage before checking regulation - also check output voltage after regulation trouble is fixed. b. Check tubes. c. Check voltage at test point (2): about +215 vdc. (Incorrect: do checks 10A and 10B).
12. Poor regulation at low line voltage.	Check R653, C650, R666, and shunt resistors on plug-in unit.
13. Poor regulation at high line voltage.	a. Check C650. b. Substitute another plug-in unit. (Symptom occurs if load is reduced while shunt resistor remains the same in plug-in unit).
14. Excessive ripple.	a. Check for correct output voltage and regulation before checking ripple-also, check output voltage and regulation after ripple trouble is fixed. b. Check tubes. c. Check voltage at test point (2): about +215 vdc. (Incorrect: do checks 10A and 10B). d. Check voltage at test point (1): about +68 vdc. (Incorrect: check R657, R659, R658). e. Check C642A, and B, C650, D642.
+300 Volt Supply Symptom and Checks similar to those described for the +125 volt supply.	
-12.2 Volt Supply (Any change in this supply may change instrument calibration).	
15. Incorrect output level, ripple or regulation	a. Check line voltage. b. Check -100 volt supply output test point (7). c. Check setting of -12.2 VOLTS adjustment (see Calibration Procedure). d. Check Q734, Q744, Q757, and F720. e. If output still incorrect go to whichever symptoms apply to steps 16 through 20.
16. Output high (too negative).	a. Check test point (9): about -12 vdc. (Incorrect: check C732, R732). b. Check test point (10): about +7.9 vdc. (Incorrect: check R734, C737). c. Check C737, R734, R744.
17. Output low or zero, (too positive).	a. Check voltage between pins 14 and 15 then 125 and 16 of T60: 15 vac \pm 10% with 117 (234) vac line. (Incorrect: check transformer primary circuit).

Maintenance—Type RM561A

Symptoms	Checks
	b. Check voltage between C720A and B terminals, test points (8) and (12): about 18 vdc. (Incorrect: check C720A, C720B, D720, D721). c. Check voltage at fuse F720: about +8.2 vdc. (Incorrect: check C757 and F720). d. Check test point (9): about -12 vdc. (Incorrect: check R731). e. Check test point (10): about +7.9 vdc. (Incorrect: check R735). f. Check C757.
18. Poor regulation at either high, low, or normal line voltage. (supply should hold regulation within $\pm 1\%$ throughout normal line voltage range.)	a. Check for correct output voltage before checking regulation-also, check output voltage after regulation trouble is fixed. b. Check for excessive loading by either plug-in units or RM561A circuits.
19. Poor regulation at low or high line voltage.	Check R734, R735, R744, and C737.
20. Excessive Ripple	a. Check for current output voltage and regulation before checking ripple-also, check output voltage and regulation after ripple trouble is fixed. b. Check ripple at test point (12): should be less than 4v peak-to-peak with load. (Excessive: do checks 17A and B). c. Check D720, D721, C720A and B, C732, C757.
CRT Circuit (Any change in this circuit may change display vertical and horizontal calibration).	
21. Any incorrect operation of CRT circuit.	a. Check line voltage. b. Check HIGH VOLTAGE adjustment, (-3300 volts at test point (21), see Calibration Procedure). If minor adjustment restores operation circuit may be normal. c. Check V822 and V832 heaters color. Dull orange - normal bright - heavy load on either tube dim - poor tube (replace) both dark - oscillator inoperative.

Symptoms	Checks
	d. If operation still incorrect, go to whichever symptoms apply of 22 through 29
22. Low Intensity	a. Check intensity control setting. b. Check V822 and R835. c. Unblanking pulse doesn't return pin 6 of crt fully to +125 v. d. Check crt.
23. High Intensity.	a. Check intensity control setting. b. Make sure spot or trace is not deflected off screen. (Spot should appear near center with both plug-in units removed). c. V822 heater open, (B856 and B857 glowing brightly show V822 open). If V822 is open check V814A. d. Check oscillator tubes and circuit including T801). e. Check C822, C842, and crt.
25. Poor astigmatism and/or focus	a. Check FOCUS and ASTIG. Control settings. b. Check HIGH VOLTAGE at pin 2 of crt, test point (20): -3300 vdc. (Incorrect: check R852). c. Check voltage at pin 9 of crt: 0 to +300 vdc when ASTIG. Control is rotated. (Incorrect: check R864 and +300 vdc to R864).
26. Blooming (size of display increases with intensity increase).	Check V800 and V822 (either may be weak).
27. No intensifying	a. D838 shorted, D839 open. b. C837 or R837 open (leading edge of long intensifying pulse missing).
28. No Z-axis modulation or no chopped blanking	C853 or R853 open. If R853 open check for shorted C853.
29. Intensity varies (unwanted Z-axis modulation).	D838 and/or D839 open.
CALIBRATOR	
30. Incorrect outputs.	a. Check CAL. AMPL. Adjustment (see Calibration Procedure). b. Check V884. c. Check voltages at test points (4) through 45). d. Use Calibration Procedure, check divider in V884B cathode.

(A)(A) 1

SECTION 4A

MAINTENANCE R561B

Introduction

This section of the manual contains information for use in preventive maintenance, corrective maintenance and troubleshooting of the Type R561B.

Access to the Interior

The top and bottom dust covers of the Type R561B can be easily removed for access to the internal circuitry. The covers should be re-installed on the instrument for normal operation to keep dust out and provide proper distribution of the air flow.

PREVENTIVE MAINTENANCE**General**

Preventive maintenance consists of periodic inspection and cleaning at regular intervals. The Type R561B should be checked approximately every 500 hours of operation, or every six months, whichever occurs first. If the instrument is subjected to adverse environmental conditions, such as excessive dust, high temperatures or high humidity, the frequency of the checks should be increased. A convenient time to perform preventive maintenance is preceding re-calibration of the instrument.

Cleaning

The Type R561B should be cleaned as often as operating conditions require. Accumulation of dirt in the instrument can cause overheating and component breakdown. Dirt on components acts as an insulating blanket and prevents efficient heat dissipation. It also provides an electrical conduction path.

The top and bottom covers provide protection against dust in the interior of the instrument. Operation without covers in place necessitates more frequent cleaning.

CAUTION

Avoid the use of chemical cleaning agents which might damage the plastics used in this instrument. Avoid chemicals which contain benzene, toluene, xylene, acetone or similar solvents.

Exterior. Loose dust accumulated on the outside of the Type R561B can be removed with a soft cloth or small point brush. The point brush is particularly useful for dislodging dirt on and around the front-panel controls. Dirt which remains can be removed with a soft cloth dampened in a

mild detergent and water solution. Abrasive cleaners should not be used.

Clean the graticule and CRT face with a soft, lint-free cloth dampened with a mild detergent and water solution.

Interior. Dust in the interior of the instrument should be removed occasionally due to this electrical conductivity under high-humidity conditions. The best way to clean the interior is to blow off the accumulated dust with dry, low-pressure air. Remove any dirt which remains with a soft paint brush or a cloth dampened with a mild detergent and water solution. A cotton-tipped applicator is useful for cleaning in narrow spaces and/or circuit boards.

The high voltage circuits, particularly parts located in the high-voltage compartment and the area surrounding the CRT socket receive special attention. Excessive dirt in these areas may cause high-voltage arcing and result in improper instrument operation.

Lubrication

The reliability of potentiometers, rotary switches and other moving parts can be maintained if they are kept properly lubricated. Use a cleaning-type lubricant (e.g., Tektronix Part No. 006-0220-001). The pot lubricant can also be used on shaft bushings. Do not over lubricate.

Fan Oiling. During periodic servicing, the fan motor should be lubricated with a few drops of light machine oil (Anderol L826 available from Lehigh Company or Rotan Distributors is recommended). An industrial hypodermic needle and syringe is used to insert the oil through the rubber seal, as shown in Fig. 4-1. Hold the syringe at a 45° angle, pierce the rubber seal, then insert the needle about 1/4 inch and depress the plunger for enough to inject 3 or 4 drops of oil into the hearing. If a syringe and needle cannot be obtained locally, they may be ordered from **NICP** (Tektronix Part No. 003-0282-00 for the syringe; 003-0285-00 for the needle).

Visual Inspection

The Type R561B should be inspected occasionally for such defects as broken connections, improperly seated transistors, damaged circuit boards and heat-damaged ports.

The corrective procedure for most visible defects is obvious; however, particular care must be taken if heat-damaged components are found. Overheating usually indicates other

(A)

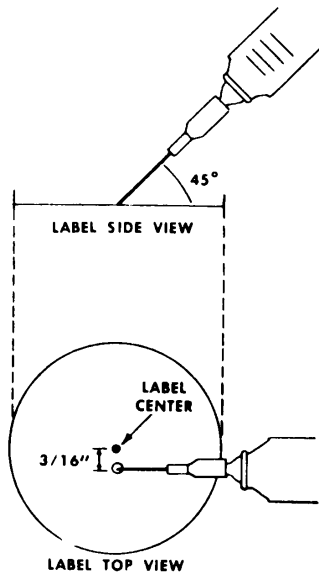

Fig. 4-1. Oiling the fan with a hypodermic.

trouble in the instrument; therefore, it is important that the cause of overheating be corrected to prevent a recurrence of the damage.

Transistor Checks

Periodic checks of the transistors in the Type R561B are not recommended. The best check of transistor performance is its actual operation in the instrument. More details on checking transistor operation are given under Troubleshooting.

Recalibration

To assure accurate measurements, check the calibration of this instrument after each 500 hours of operation or every six months if used infrequently. In addition, replacement of components may necessitate recalibration of the affected circuits. Complete calibration instructions are given in the Calibration section.

The calibration procedure can also be helpful in localizing certain troubles in the instrument. In some cases, minor troubles may be revealed and/or corrected by recalibration.

TROUBLESHOOTING

Introduction

The following information is provided to facilitate troubleshooting in the Type R561B. Information contained in other sections of this manual should be used along with the following information to aid in locating the defective components. When replacing a defective semiconductor, be certain that all associated components are in good condition

before application of power, a precaution which may prevent further damage. An understanding of the circuit operation is very helpful in locating troubles. See the Circuit Description section for complete information.

Troubleshooting Aids

Diagrams. Circuit diagrams are given on fold-out pages in Section 8. The component number and electrical value of each component in this instrument are shown on the diagrams. Each main circuit is assigned a series of component numbers. Table 4-1 lists the main circuits in the Type R561B and the series of component numbers assigned to each. Important voltages and waveforms are also shown on the diagrams at the rear of this manual. The portion of the circuit mounted on the circuit board is enclosed with a blue line.

Table 4-1
Component Numbers

Component Numbers on Diagrams	Diagram Number	Circuit
1.99	1	Power Supply
100-110	2	Plug-in Connectors
150-199	3	1 kHz Calibrator
200-299	4	CRT circuit

Switch Wafer Identification. Switch wafers shown on the diagrams are coded to indicate the position of the wafer in the complete switch assembly. The numbered portion of the code refers to the wafer number counting from the front, or mounting end of the switch, toward the rear. The letters F and R indicate whether the front or rear of the wafer performs the particular switching function. For example, a wafer designated 2R indicates that the rear of the second wafer J (from the front) is used for this particular switching function.

Circuit Boards. Fig. 4-5 through 4-7 show the circuit boards used in the Type R561B. Each electrical component on each board is identified by its circuit number. The circuit board is also outlined on its schematic diagram with a blue line. These pictures used with the diagrams will aid in locating the components mounted on the circuit boards.

Wiring Color Code. All insulated wire and cable used in the Type RSS61B is color-coded to facilitate circuit tracing. Signal carrying leads are identified with three stripes to indicate the approximate voltage, using the EIA resistor color code. A white background color indicates a positive voltage and a tan background indicates a negative voltage. The widest color stripe identifies the first color of the code. Table 4-2 gives the wiring color code for the power supply voltages used in the Type R561B.

TABLE 4-2
Power Supply Wiring Color Code

Supply	Back-ground Color	First Stripe	Second Stripe	Third Stripe
+300 V	White	Orange	Black	Brown
+125 V	White	Brown	Red	Brown
-12.2 V	Tan	Brown	Red	Black
-100 V	Tan	Brown	Black	Brown

Resistor and Capacitor Color Code					
Color	Significant Figures	Multiplier		Tolerance	
		Resistors	Capacitors	Resistors	Capacitors
Silver	---	10^{-2}	---	$\pm 10\%$	---
Gold	---	10^{-1}	---	$\pm 5\%$	---
Black	0	1	1	---	$\pm 20\%$ or 2 pF*
Brown	1	10	10	$\pm 1\%$	$\pm 1\%$ or 0.1 pF*
Red	2	10^2	10^2	$\pm 2\%$	$\pm 2\%$
Orange	3	10^3	10^3	$\pm 3\%$	$\pm 3\%$
Yellow	4	10^4	10^4	$\pm 4\%$	+100% -0%
Green	5	10^5	10^5	$\pm 0.5\%$	$\pm 5\%$ or 0.5 pF*
Blue	6	10^6	10^6	---	---
Violet	7	---	---	---	---
Gray	8	---	10^{-2}	---	+80% -20% or 0.25 pF*
White	9	---	10^{-1}	---	$\pm 10\%$ or 1 pF*
(none)	---	---	---	$\pm 20\%$	$\pm 10\%$ or 1 pF*

*For capacitance of 10 pF or less.

NOTE: (T) and/or (TC) color code for capacitors depends upon manufacturer and capacitor type. May not be present in some cases.

Fig. 4-2. Standard EIA color code

Resistor Color Code. In addition to the brown composition resistors, some metal-film resistors and some wire-wound resistors are used in the Type R561B. The resistance values of wire-wound resistors are printed on the body of the component. The resistance values of composition resistors and metal-film resistors are color-coded on the components with EIA color code (some metal-film resistors may have the value printed on the body). The color code is read starting with the stripe nearest the end of the resistor. Composition resistors have four stripes which consist of two significant figures, a multiplier and a tolerance value (see Fig. 4-2). Metal-film resistors have five stripes consisting of three significant figures, a multiplier and a tolerance value.

Capacitor Marking. The capacitance values of common disc capacitors and small electrolytic are marked in microfarads on the side of the component body. The white ceramic capacitors used in the Type R561B are color coded in picofarads using a modified EIA color code (see Fig. 4-2).

Diode Color Code. The cathode end of a glass-enclosed diode is indicated by a stripe, a series of stripes or a dot. For most silicon or germanium diodes with a series of stripes, the color code identifies the three significant digits of the Tektronix Part Number using the resistor color-code system (e.g., a diode color-coded blue-brown-gray-green (6, 1, 8, 5) indicates Tektronix Part Number 152-0185-00). The cathode and anode ends of metal diodes can be identified by the diode symbol marked on the body.

Troubleshooting Equipment

The following equipment is useful for troubleshooting the Type R561B:

1. Transistor Tester

Description: Tektronix Type 575 Transistor Curve Tracer or equivalent.

Purpose: To test the semiconductors used in this instrument.

2. Multimeter

Description: Electronic Voltmeter, 10 megohms, or greater, input resistance; 0 to 500 volts; 0 to 50 megohms. Accuracy, within 3% (1% is necessary to check power supply voltages). Test prods must be insulated to prevent accidental shorting.

Purpose: To check operating voltages and for general troubleshooting in this instrument.

NOTE

A 20,000 ohms/volt VOM can be used to check the voltages in this instrument if allowances are made for the circuit loading of the VOM at high impedance points.

(A)

Maintenance—Type R561B

3. Test Oscilloscope (with 1X and 10X probes).

Description: DC to 1 MHz frequency response, 1 milli-volt to 10 volts/division deflection factor.

Purpose: To check waveforms in the instrument.

Troubleshooting Techniques

This troubleshooting procedure is arranged in an order which checks the simple trouble possibilities before proceeding with the extensive troubleshooting. The first few checks assure proper connection, operation and calibration. If the trouble is located by these checks, the remaining steps aid in locating the defective component. When the defective component is located, it should be replaced following the replacement procedures given under Corrective Maintenance.

1. Check Control Settings. Incorrect control settings can indicate a trouble that does not exist. If there is any question about the correct function or operation of any control, see the Operating Instructions section of the manual.

2. Check Associated Equipment. Before proceeding with troubleshooting of the Type R561B, check that the equipment used with this instrument is operating correctly. Substitute another vertical or time-base plug-in which is known to be operating properly. Check that the signal is properly connected and that interconnecting cables are not defective. Also, check the power source.

3. Visual Check. Visually check the portion of the instrument in which the trouble is located or suspected. Many troubles can be located by visual indications such as unsoldered connections, broken wire, damaged circuit boards, damaged components, etc.

4. Check Instrument Calibration. Check the calibration of this instrument, or the affected circuit if the trouble exists in one circuit. The apparent trouble may only be a result of misadjustments or may be corrected by calibration. Complete calibration instructions are given in the Calibration section.

5. Isolate Trouble to a Circuit. To isolate trouble to a circuit, note the trouble symptom. The symptom often identifies the circuit in which the trouble is located. For example, poor focus indicates that the CRT circuit (includes high voltages) is probably at fault. When trouble symptoms appear in more than one circuit, check affected circuits by taking voltage and waveform readings.

Incorrect operation of all circuits often indicates trouble in the power supplies. However, a defective component elsewhere in the instrument can appear as a power supply trouble and may also affect the operation of other circuits.

NOTE

Turn the instrument off before attempting to remove or replace connections to any circuit board.

Table 4-3 lists the tolerances of the power supplies in this instrument. If a power supply voltage is within the listed tolerance, the supply can be assumed to be working correctly. If outside the tolerance, the supply may be misadjusted or operating incorrectly. Use the procedure given in the Calibration section to adjust the power supplies.

TABLE 4-3
Power Supply Tolerances

Power Supply	Tolerance
-3300 V	Within 3%
-100V	Within 0.5%
-12.2V	Within 1.2%
+125V	Within 1.5%
+300V	Within 1.5%

6. Check Circuit Board Interconnections. After the trouble has been isolated to a particular circuit, check the pin connectors on the circuit board for correct connection. Figs. 4-5 through 4-7 show the correct connections for each board.

The pin connectors used in this instrument also provide a convenient means of circuit isolation. For example, a short circuit in a power supply can be isolated to the power supply itself by disconnecting the pin connectors for that voltage at the remaining boards.

7. Check Voltages and Waveforms. Often the defective component can be located by checking for correct voltage or waveforms in the circuit. Ideal voltages are given on the diagrams.

NOTE

Voltages given on the diagrams are calculated with the assumption that conditions are ideal (variable components at design center, etc.), and may vary slightly from actual measured voltages.

8. Check Individual Components. The following procedures describe methods of checking the individual components in the Type R561B. Components which are soldered in place are best checked by disconnecting one end. This isolates the measurement from the effects of surrounding circuitry.

A. TRANSISTORS. The best check of transistor operation is actual performance under operating conditions. If a transistor is suspected of being defective, it can best be checked by substituting a new component or one which has been checked previously. However, be sure that circuit conditions are not such that a replacement transistor might also be damaged. If substitute transistors are not available, use a dynamic tester (such as Tektronix Type 575). Static type testers may be used, but since they do not check operation under simulated operating conditions, some defects may go unnoticed. Fig. 4-3 shows transistor base pin and socket arrangements. Be sure power is off before attempting to remove or replace any transistor.

B. DIODES. A diode can be checked for an open or shorted condition by measuring the resistance between terminals. With an ohmmeter scale having an internal source of between 800 millivolts and 3 volts, the resistance should be high in one direction and low when the leads are reversed.

C. RESISTORS. Check the resistors with an ohmmeter. See the Electrical Parts List for the tolerance of the resistors used in this instrument. Resistors normally need not be

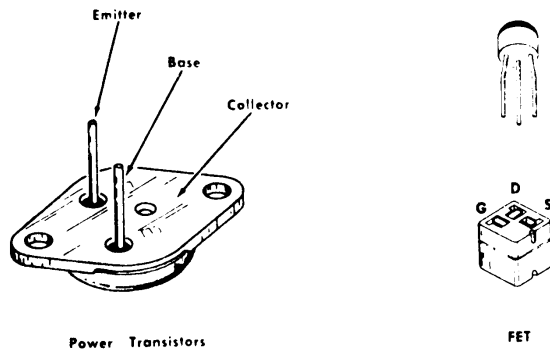
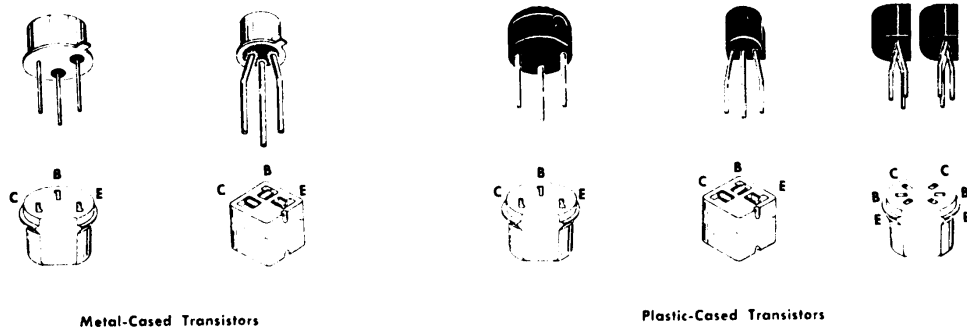

Fig. 4-3. Transistor electrode configuration data.

replaced unless the measured value varies widely from the specified value.

D. CAPACITORS. A leaky or shorted capacitor can be determined by checking resistance with an ohmmeter on the highest scale. Use an ohmmeter which will not exceed the voltage rating of the capacitor. The resistance reading should be high after initial charge of the capacitor. An open capacitor can best be detected with a capacitance meter or by checking whether the capacitor passes AC signals.

9. Troubleshooting in the Low Voltage Power Supplies. The low voltage supplies incorporate special circuitry to

prevent damage due to short circuits on the voltage output lines. When this circuitry is operating properly, the low voltage supplies are extremely reliable. If any trouble occurs in the low-voltage power supply (Diagram 1), be certain that all defective components are replaced before reapplication of power. Otherwise uncorrected problems could cause further damage, including damage to the new component. Although not every situation can be predicted, such occurrences will be unlikely if the following precautions are taken:

- A. Turn the power off.

(A)

Maintenance—Type R561B

B. If the problem is possibly in the -100-, or +125-, or +300-volt supplies, visually check current sensing resistors R33, R75 and R94 for charring or cracking. For location of components, refer to Fig. 4-5.

C. Check current-sensing transistors Q30, Q38, Q70 and Q91 on a transistor checker.

D. If a current-sensing resistor or transistor has failed, check all remaining diodes and transistors in the corresponding section of circuitry (see Table 4-4). Most of the diodes mentioned can be checked in the circuit using an ohmmeter.

TABLE 4-4

Component Failure	Check
Q38	D35A, D35B, D47, Q44, Q46, Q49, Q51
Q30 or R33	D8A, D8B, D8C, D8D, D19, D25, D31, Q12, Q14, Q24, Q28, Q30, Q32
Q70, Q91, R75 or R94	D53A, D53B, D53C, D53D, D62, D65, D75, D76, D77A, D77B, D77C, D77D, D80, D95, Q58, Q60, Q66, Q68, Q74, Q84, Q86, Q88, Q90, Q96

E. Make a careful visual check of R8, R52, R53, R61, R69, R77 and R82 for charring or cracks.

F. Re-apply the power. If a line-voltage auto-transformer is available, gradually increase the line voltage from zero volts to 115 volts (or to the center of the regulating range to which the Voltage Selector Assembly is set) while monitoring the output of the low-voltage supply.

10. Repair and Readjust the Circuit. If any defective parts are located, follow the corrective maintenance procedures in this section. Be sure to check the performance of any circuit that has been repaired or that has had any electrical components replaced.

CORRECTIVE MAINTENANCE

General

Corrective maintenance consists of component replacement and instrument repair. Special techniques required to replace components in this instrument are given here.

Obtaining Replacement Parts

See page 7-0.

NOTE

When selecting replacement parts, it is important to remember that the physical size and shape of the component may affect its performance in the instrument. All replacement parts should be direct replacements unless it is known that a different

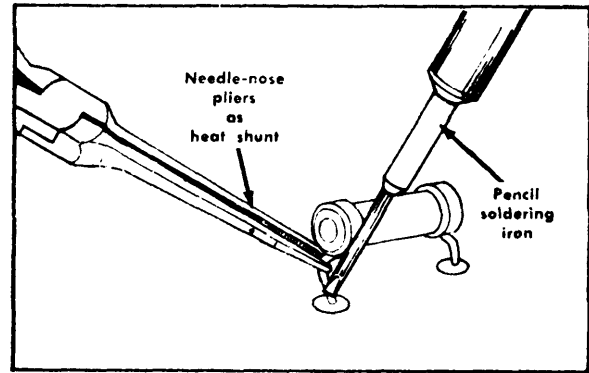

Fig. 4-4. Removing or replacing component on circuit board.

component will not adversely affect instrument performance.

Soldering Techniques

WARNING

Disconnect the instrument from the power source before soldering.

Circuit Boards. Use ordinary 60/40 solder and a 35- to 40-watt pencil-type soldering iron on the circuit boards. The tip of the iron should be clean and properly tinned for best heat transfer to the solder joint. A higher wattage iron may separate the wiring from the base material. The following technique should be used to replace a component without removing the boards from the instrument:

1. Grip the component lead with long-nose pliers. Touch the soldering iron tip to the lead at the solder connection. Do not lay the iron directly on the board, as it may damage the board. See Fig. 4-4.

When the solder begins to melt, pull the lead out gently. This should leave a clean hole in the board. If not, the hole can be cleaned by reheating the solder and placing a sharp object such as a toothpick into the hole to clean it out.

(A)

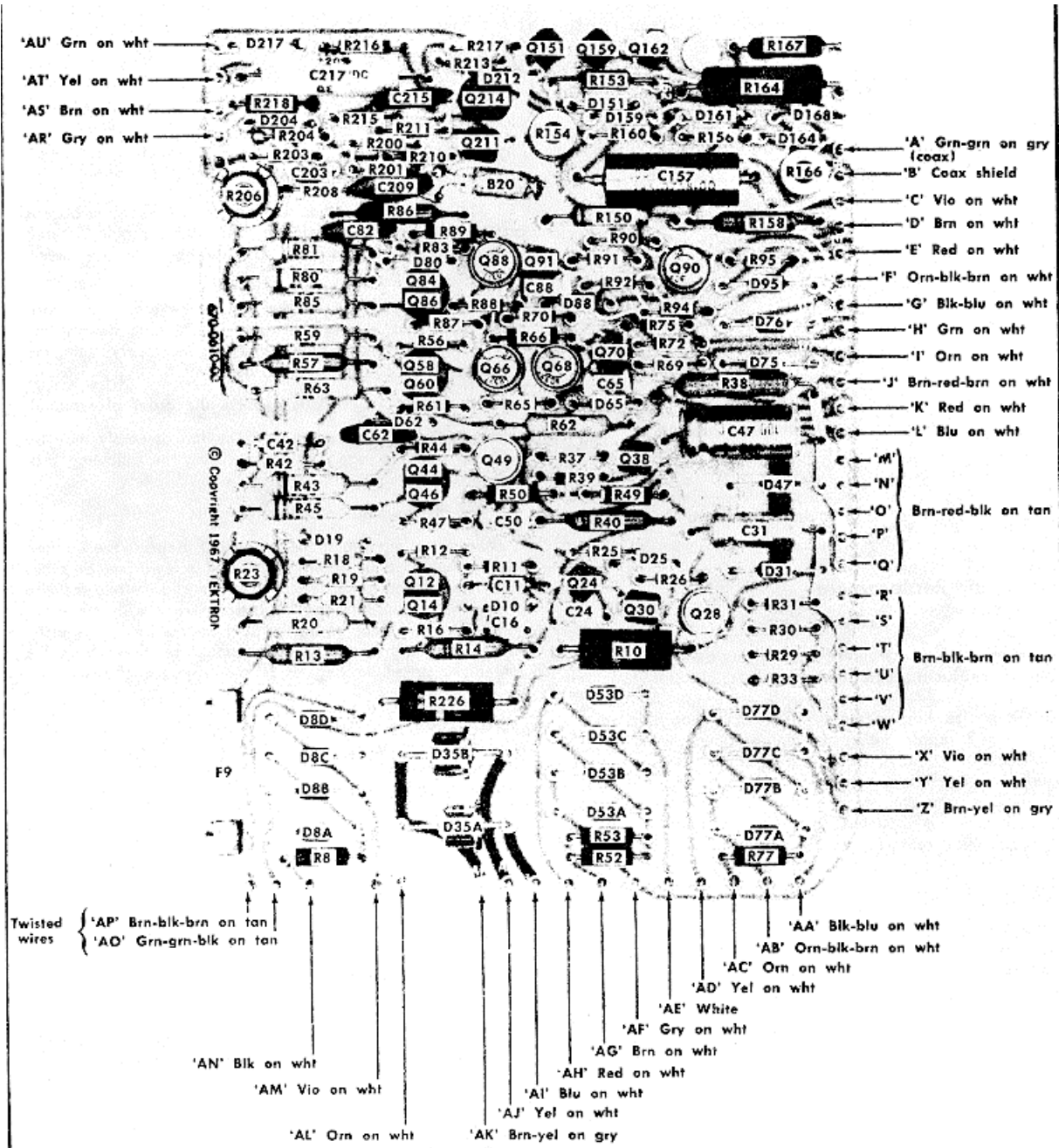

Fig. 4-5 Low Voltage Power Supply and 1 kHz Calibrator circuit board.

(A) 1

Maintenance—Type R561B

3. Bend the leads of the new component to fit the holes in the board. Insert the leads into the holes in the board so the component is firmly seated against the board (or as positioned originally). If it does not seat properly, heat the solder and gently press the component into place.

4. Touch the iron to the connection and apply a small amount of solder to make a firm solder joint. To protect heat-sensitive components, hold the lead between the component body and solder joint with a pair of long-nose pliers or other heat sink.

5. Clip the excess lead that protrudes through the board (if not clipped in step 3).

6. Clean the area around the solder connection with a flux-remover solvent. Be careful not to remove information printed on the board. Metal Terminals. When soldering metal terminals (e.g., switch terminals, potentiometers, etc.) ordinary 60/40 solder can be used. Use a soldering iron with a 40- to 75-watt rating and a 1/8-inch wide wedge-shaped tip. Observe the following precautions when soldering metal terminals:

1. Apply heat only long enough to make the solder flow freely.

2. Apply only enough solder to form a solid connection. Excess solder may impair the function of the part.

3. If a wire extends beyond the solder joint, clip off the excess.

4. Clean the flux from the solder joint with a flux-remover solvent.

Component Replacement

WARNING

Disconnect the instrument from the power source before replacing components.

Circuit Board Replacement. If a circuit board is damaged beyond repair, either the entire assembly including all soldered-on components, or the board only, can be replaced. Part numbers are given in the Mechanical Parts List for either the completely wired or the unwired board. Many of the components mounted on the circuit boards can be replaced without removing the boards from the instrument. Observe the soldering precautions given under Soldering Techniques in this section. However, if the bottom side of the board must be reached or if the board must be moved to gain access to other areas of the instrument, the mounting screws need to be removed and it may be necessary to disconnect some of the interconnecting wires from the pin connectors. Refer to Figs. 4-5 through 4-7 for component locations and interconnecting wire identifying colors.

GENERAL:

Most of the connections to the circuit boards are made with pin connectors; however, the connections to the High Voltage circuit boards are soldered. See the special instructions to remove these boards as units.

Use the following procedure to remove a circuit board:

1. Disconnect all the pin connectors.
2. Remove all screws that hold the board to the chassis.
3. Lift the board out of the instrument. Do not force or bend the board.

4. To replace the board, reverse the order of removal. Replace the pin connectors carefully so they mate correctly with the pins. If forced into place incorrectly positioned, the pin connectors may be damaged.

HIGH VOLTAGE BOARD REMOVAL:

1. Remove the metal high voltage shield (secured to the chassis by two nuts on the opposite side of the chassis).

2. Remove the plastic cover on the high voltage compartment (held in place with three screws).

3. Unsolder the two diodes connected between the boards and the high-voltage transformer. Extra care should be used to avoid damaging the plastic compartment with the soldering iron.

4. Ease the board assembly out of the plastic compartment, while unsoldering the wires on the side nearest the transformer. Unsolder other wires as necessary until the entire assembly can be removed as a unit.

5. To replace the boards, reverse the order of removal.

Fan Assembly Replacement. The fan assembly may be removed from its snap-in mounting using the following procedure:

1. Pry off the snap-in protective grille.

2. From the interior of the instrument, depress the holding clip on one side by inserting a small screwdriver or other tool between the fan assembly and the clip. While the clip is depressed, pull the fan toward the rear with the other hand until it is clear of the holding fingers (about 1/2 inch). At this stage, the fan assembly should be tilted from the centerline, since the fingers on the opposite clip will still be engaged.

3. Depress the opposite holding clip while pulling the fan assembly to the rear. When the fan assembly is free of the holding fingers of both clips, it may be pulled free of the snap-in mounting to the length of the power leads.

4. To completely disconnect the fan assembly from the instrument, unsolder the two power leads.

5. To replace the fan, reverse the order of removal. Very little pressure is required to properly seat the fan assembly in the holding clips, provided the alignment is correct. To assure proper alignment, observe that the upper and lower ends of the holding clips are curved inward to form flanges and that the sides of the fan assembly are grooved to accept the flanges when alignment is correct.

Cathode-Ray Tube Replacement. The following procedure outlines the removal and replacement of the cathode-ray tube:

A. REMOVAL:

1. Remove the bezel (held in place with four knurled nuts) and the plastic graticule light conductor. Also remove any filters that may be in front of the graticule.

(A)

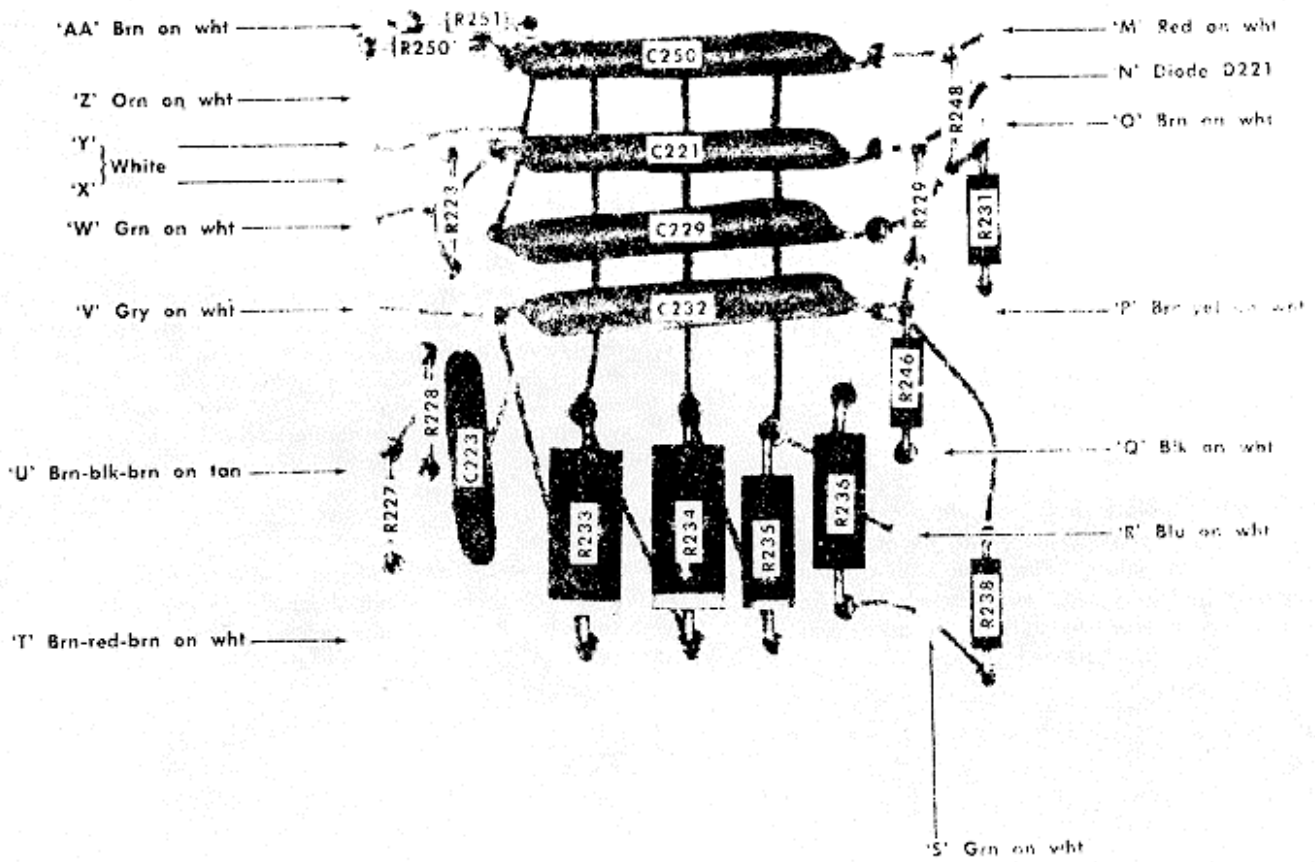

Fig. 4-6. Upper High Voltage circuit board

(A)1

Maintenance—Type R561B

2. Disconnect the deflection-plate leads. Be careful not to bend the deflection-plate pins.
3. Remove the fan assembly as outlined in the preceding paragraphs.
4. Remove the CRT base socket.
5. Loosen the three screws on the CRT clamp inside the CRT shield (base end). Do not remove the screws. (One of these screws is for the clamp; the other two permit positioning of the clamp.)
6. Pushing on the CRT base, slide the CRT forward. Pull the CRT out of the instrument from the front. Be sure that the CRT neck-pins clear the shield edge as the CRT is pushed out.

WARNING

High vacuum cathode-ray tubes are dangerous to handle. To prevent personal injury from flying glass in case of tube breakage, wear face mask or safety goggles, and gloves.

Handle the CRT with extreme care. Do not strike or scratch it. Never subject it to more than moderate force or pressure when removing or installing.

Always store spare CRT's in original protective cartons. Save cartons to dispose of used CRT's.

7. Remove the boot (shock mounting gasket) and graticule from the CRT faceplate.

B. REPLACEMENT:

1. Make sure the faceplate and graticule are clean, then place the graticule on the faceplate (with the etched graticule lines against the faceplate). Place the boot around the CRT faceplate and graticule such that the two tabs on the graticule extend through the two slots in the boot, and the graticule is held firmly against the faceplate.
2. Check that the CRT base pins are straight (make a test installation of the CRT base socket onto the base pins outside the instrument), then insert the CRT into the shield. Guide the CRT base into the clamp and slide the CRT toward the rear of the instrument.
3. Tighten the clamp screw inside the CRT shield, leaving the two positioning screws loose. Recommended tightening torque: 4 to 7 inch-pounds.
4. Align the CRT faceplate square with the front of the instrument by positioning the CRT base. Tighten the two positioning screws.
5. Replace the light conductor, filter (if used), bezel and securing nuts.
6. Place the CRT base socket onto the CRT base pins.
7. Replace the deflection-plate pin connectors. Correct location is indicated on the CRT shield.
8. Replace the fan assembly.
9. Replacing the CRT will require instrument recalibration. Refer to Calibration, Section 5.

(A)

Scale Illumination Lamp Replacement. The procedure is as follows:

1. Remove the CRT bezel (held in place with four knurled nuts) and the plastic graticule light conductor. Also remove any filters that may be in front of the graticule.
2. Remove the Storage board to gain access to the lamp sockets.
3. Loosen the nut holding the adjustable lamp-socket bracket and slide the bracket forward through the front panel as far as possible.
4. Remove the defective lamp by pulling straight out with the fingers.
5. Insert the new lamp. Be sure it is pushed all the way into the socket.
6. Adjust the lamp-socket bracket for proper protrusion through the front panel. It must fit into the cavity in the plastic light conductor.
7. Replace the Storage board, light conductor, filters (if any) and bezel.

Transistor Replacement. Transistors should not be replaced unless they are actually defective. If removed from their sockets during routine maintenance, return them to their original sockets. Unnecessary replacement or switching of components may affect the calibration of the instrument. When a transistor is replaced, check the operation of that part of the instrument which may be affected.

Any replacement component should be of the original type or a direct replacement. Remount the components in the same manner as the original. Fig. 4-3 shows the lead configurations of the transistors used in this instrument.

Transistors which are mounted on the heat sin., on the rear panel use a special thermal-joint compound to increase heat transfer. Replace the compound when replacing these transistors.

WARNING

If silicone grease is used as a thermal-joint compound, handle the silicone grease with care. Avoid getting silicone grease in the eyes. Wash hands thoroughly after use.

Fuse Replacement. Table 4-5 gives the rating, location and function of the fuses used in this instrument.

TABLE 4-5

Circuit Number	Rating	Location	Function
F1	3.2A	Line Voltage Selector	115-volt line
	Slo-blow	assembly	
F2	2 A	Line Voltage Selector	230-volt line
F9	0.15 A	Low Voltage Power	High Voltage
	Fast-blow	Supply circuit board	

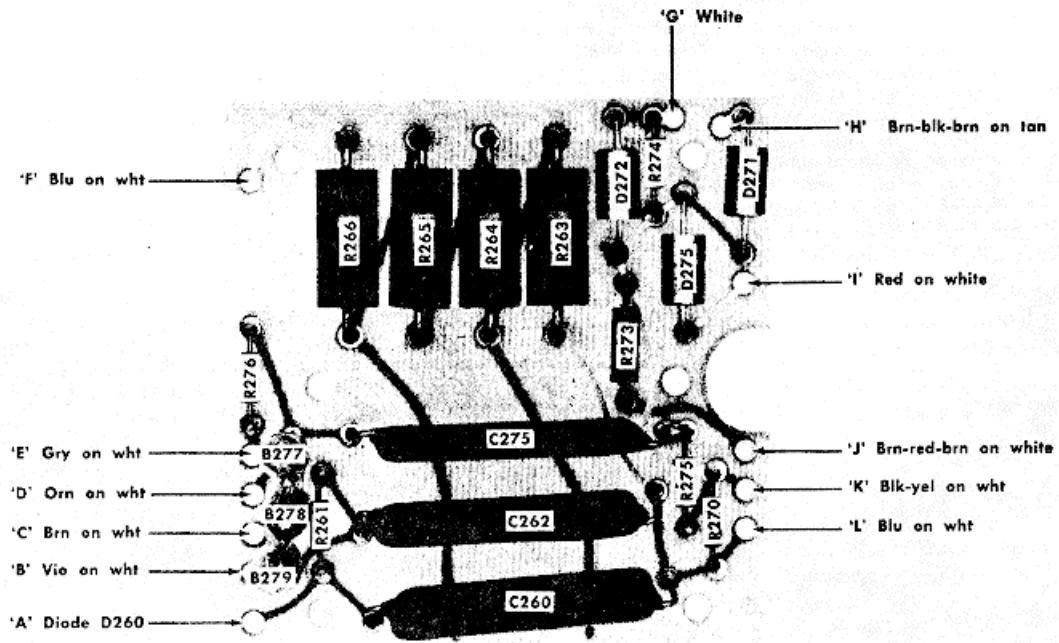

Fig. 4-7. Lower High Voltage circuit board.

(A)

4-11A

Maintenance—Type R561B

Rotary Switches. Individual wafers or mechanical parts of rotary switches are normally not replaceable. If a switch is defective, replace the entire assembly. Replacement switches can be ordered either wired or unwired; refer to the Parts List for the applicable part numbers.

When replacing a switch, tag the switch terminals and leads with corresponding identification tags as a guide for installing the new switch. An alternate method is to draw a sketch of the switch layout and record the wire color at each terminal. When soldering to the new switch, be careful that the solder does not flow beyond the rivets on the switch terminal. Spring tension of the switch contact can be destroyed by excessive solder.

Power Transformer Replacement. The power transformer in this instrument is warranted for the life of the instrument. If the power transformer becomes defective, contact your local Tektronix Field Office or representative for a warranty replacement (see the Warranty note in the front of this manual). Be sure to replace only with a direct replacement Tektronix transformer.

When removing the transformer, tag the leads with the corresponding terminal numbers to aid in connecting the new transformer. After the transformer is replaced, check the performance of the complete instrument using the Performance Check instructions in Section 5, Calibration.

High-Voltage Compartment. The components located in the high-voltage compartment can be reached for maintenance or replacement by using the following procedure:

1. Remove the metal high-voltage shield by removing the two hexagonal nuts on the opposite side of the chassis.

2. Remove the plastic cover (held in place with three screws).

3. To remove the complete wiring assembly from the high-voltage compartment, first unsolder the two diodes connected between the board assembly and the high-voltage transformer and then lift the board assembly out far enough to unsolder the leads connecting to the side of the assembly closest to the transformer. Unsolder other leads as necessary to allow the board assembly to be lifted free of the instrument.

4. To remove the high-voltage transformer, unsolder the leads connecting to the pins on the top of the transformer.

5. To replace the high-voltage compartment, reverse the order of removal.

NOTE

All solder joints in the high-voltage compartment should have smooth surfaces. Any protrusions may cause high-voltage arcing at high altitudes.

Recalibration After Repair

After any electrical component has been replaced, the calibration of that particular circuit should be checked, as well as the calibration of other closely related circuits. Since the low-voltage supply affects all circuits, calibration of the entire instrument should be checked if work has been done in the low-voltage power supply or if the power transformer has been replaced. The Performance Check instructions outlined in Section 5 provide a quick and convenient means of checking the instrument operation.

SECTION 5
PERFORMANCE CHECK RM561A

Introduction

This section of the manual provides a means of rapidly checking the performance of the-Type RM561A. It is intended to check the calibration of the instrument without the need for performing the complete Calibration Procedure. The Performance Check does not provide for the adjustment of any internal controls. Failure to meet the requirements given in this procedure indicates the need for internal checks or adjustments, and the user should refer to the Calibration Procedure in this manual.

Recommended Equipment

The following equipment is recommended for a complete performance check. Specifications given are the minimum necessary to perform this procedure. All equipment is assumed to be calibrated and operating within the original specifications. If equipment is substituted, it must meet or exceed the specifications of the recommended equipment.

For the most accurate and convenient performance check, special calibration fixtures are used in this procedure. These calibration fixtures are available **the NICP**.

1. Tektronix 2- or 3-series amplifier plug-in unit.
2. Tektronix 2- or 3-series time-base plug-in unit.
3. Variable auto-transformer. Must be capable of supplying at least 350 volt-amperes over a voltage range of 105 to 125 volts (210 to 250 volts for 234-volt nominal line). For example, General Radio W10MT3 Metered Variac Auto-transformer.
4. Test oscilloscope. Frequency response, 10MHz; minimum deflection factor, 0.005 volts/division. Tektronix Type 561A/RM with Type 3A1 and 2A63 Amplifier Plug-ins and Type 3B4 Time-Base Plug-In recommended.
5. CRT deflection capacitance normalizer. Tektronix Calibration Fixture, 067-0500-00, recommended.
6. Standard amplitude calibrator. Amplitude accuracy, 0.25%; signal amplitude, 50 millivolts to 100 volts; output signals, 1-kHz square-wave. Tektronix Calibration Fixture, 067-0502-00, recommended.
7. Time-mark generator. Marker outputs, 1 μ s and 100 μ s; accuracy 0.001%. Tektronix Type 184 Time-Mark Generator recommended.
8. Termination. Impedance, 50-ohm; accuracy, $\pm 3\%$; connectors, BNC. Tektronix Part No. 011-0049-00.
9. Cable (two). Impedance, 50-ohm; connectors, BNC Tektronix Part No. 012-0057-00.
10. Patch cord. Length, 18-inch; connectors, BNC-to-banana plug. Tektronix Part No. 012-0091-00.

¹Use maximum performance plug-in units. For example, use a high-frequency unit in performance to low-frequency, dual-trace rather than single-trace, etc.

(A)(B)

-
11. Patch cord. Length, 18-inch; connectors, BNC-to-BNC Tektronix Part No. 012-0087-00.

PERFORMANCE CHECK PROCEDURE

General

In the following procedure, test equipment connection or control settings should not be changed except as noted. If only a partial check is desired, refer to the preceding step(s) for setup information.

The following procedure uses the equipment listed under Recommended Equipment. If substitute equipment is used, control settings or setup must be altered to meet the requirements of the equipment used.

Preliminary Procedure

1. Insert the amplifier plug-in in the left plug-in compartment.
2. Insert the time-base plug-in unit in the right plug-in compartment.
3. Connect the auto-transformer to a suitable power source.
4. Connect the Type RM561A to the auto-transformer output.
5. Set the auto-transformer to 115 (or 230) volts.
6. Set the Type RM561A POWER switch to ON. Allow at least 20 minutes warm up for checking the instrument to the given accuracy. Set the following controls:

Type RM561A

FOCUS	Any position
INTENSITY	Midrange
CALIBRATOR	OFF
SCALE ILLUM	Clockwise
CRT CATHODE SELECTOR	Normal

Amplifier Unit

Position	Midrange
Ac Dc Gnd	Ac
Volts/Division	1
Variable	Calibrated

Time-Base Unit

Position	Midrange
Magnifier	Off
Time/Division	1 millisecond
Variable	Calibrated
Triggering controls	Adjusted for free running trace

Performance Check—Type RM561A

1. Check CRT for Double Peaking

a. Requirement—There should be a constant increase in trace intensity as each INTENSITY control is rotated clockwise. All signs of double peaking must be gone within 3 minutes.

b. Turn the INTENSITY control counterclockwise and then slowly clockwise.

c. Check—For a constant increasing brightness of the trace. If the trace brightens, then decreases intensity and then constantly brightens again it is double peaking.

d. Turn the INTENSITY control counterclockwise from its fully clockwise position.

e. Check—For a constantly decreasing brightness. If the trace brightness decreases, then increases and then decreases once more, this again is double peaking.

f. Readjust the INTENSITY control for a usable trace brightness.

2. Checking Calibrator

a. Requirement—The signal amplitude accuracy must be within 3% of the indicated peak-to-peak amplitude except at the .1V INTO 50Ω where it is ±3.5% when terminated with 50 ohms. The symmetry must be within ±20% of being a 50% duty cycle and the rise-time must not exceed 6 μs.

b. Set the test oscilloscope Volts/Div switch to 10.

c. Connect a 50-ohm coaxial cable from the test oscilloscope vertical input connector to the Output of the standard amplitude calibrator.

d. Connect a second 50-ohm coaxial cable from the Unknown Input of the standard amplitude calibrator to the CAL OUT connector of the Type RMS61A.

e. Set the Mode switches of the standard amplitude calibrator to Square-Wave and Mixed.

f. Set the CALIBRATOR to 100 VOLTS.

g. Using Table 5-1, switch the Amplitude control of the standard amplitude calibrator and the CALIBRATOR control of the Type RM561A simultaneously to each setting listed in the table.

h. Check—Top of the mixed square-wave presentation noting the amount of trace separation. The trace separation noted must not exceed the amount listed in Table 5-1.

TABLE 5-1

Calibrator Switch Settings	Test Oscilloscope Volts/Div switch Settings	Maximum Trace Separation
100 Volts	10	3 mm
50 Volts	5	3 mm
20 Volts	2	3 mm
10 Volts	1	3 mm
5 Volts	.5	3 mm
2 Volts	.2	3 mm
1 Volt	.1	3 mm
.5 Volt	.05	3 mm
.2 Volt	.02	3 mm
.1 Volt	.01	3 mm
50 mVolts	.005	3 mm

i. Set the standard amplitude calibrator Amplitude control to .1 Volt and the Type RM561A CALIBRATOR control to .1 V INTO 50 Ω.

j. Disconnect the 50-ohm coaxial cable from the Type RM561A CAL OUT connector.

k. Connect a 50-ohm termination to the CAL OUT connector, then connect the 50-ohm coaxial cable that was removed in part j to the 50-ohm termination.

l. Set the test oscilloscope Volts/Div switch to .01.

m. Check—For not more than 3.5 mm of trace separation.

n. Remove the coaxial cables and the 50-ohm termination connections.

o. Connect a 50-ohm coaxial cable from the Type RM561A CALIBRATOR to the test oscilloscope vertical input connector.

p. Set the CALIBRATOR for a two-volt output.

q. Adjust the test oscilloscope Volts/Div and Position controls to obtain a 4-cm high display centered about the center horizontal graticule line.

r. Set the Time/Div switch to 1 ms and the Triggering Level control for a stable display.

s. Adjust the test oscilloscope Horizontal Position control and Time/Div Variable control until one complete cycle of the square-wave presentation occupies the center 8 cm of the graticule.

t. Check—The width, in centimeters, of the positive-going portion of the square-wave presentation. The width should not be less than 3.2 cm nor more than 4.8 cm for a square-wave whose duty cycle is 50% ±20%.

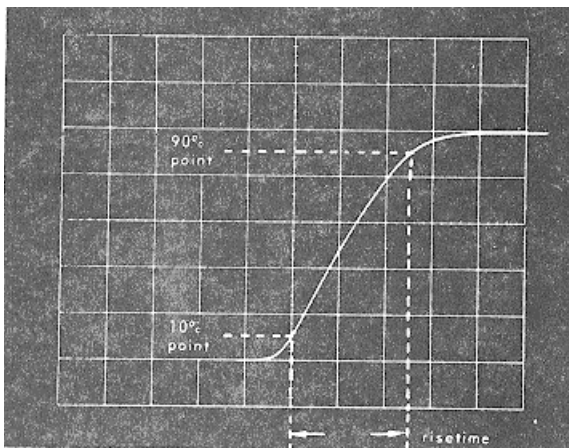

Fig. 5-1. Measuring rise time.

(A)(B)

Performance Check — Type RM561A

- u. Return the Time/Div Variable control to its Calibrated position and set the Time/Div switch to 1 μ s.
- v. Position the rising portion of the display to the center vertical graticule line with the Horizontal Position control.
- w. Check—The rise-time (see Fig. 5-1). The rise-time should not exceed 6 μ s.
- x. Remove the coaxial cable and set the Type RM561A CALIBRATOR to OFF.

3. Graticule Scale Illumination

- a. Requirement—There should not be any flickering of the graticule scale illumination as the SCALE ILLUM control is rotated throughout its range.. When the SCALE ILLUM control is fully counterclockwise there should be no illumination, and with the control fully clockwise there should be maximum illumination.
- b. Set the SCALE ILLUM control fully counterclockwise.
- c. Check—For no graticule illumination.
- d. Check—That as the control is slowly rotated clock-wise the graticule illumination does not flicker.
- e. Check—For maximum graticule illumination when the control has been rotated to its fully clockwise position.
- f. Set the SCALE ILLUM control for a usable graticule illumination level.

4. Trace Alignment

The trace should be parallel to the horizontal graticule lines, but due to the different effects that the earth's magnetic field will have at various locations, it is impossible to state that the trace should be aligned within plus or minus a specific tolerance.

If the trace is not parallel to the horizontal graticule lines it will be necessary to adjust the ALIGNMENT control until the trace is parallel to the horizontal graticule lines.

5. Horizontal Position Control

- a. Requirement--Clockwise rotation of the control should move the trace smoothly to the right, while counter-clockwise rotation of the control should move the trace smoothly to the left.
- b. Rotate the horizontal position control clockwise.
- c. Check—That the trace moved smoothly to the right.
- d. Rotate the horizontal position control counter-clockwise.
- e. Check—That the trace moved smoothly to the left.
- f. Return the horizontal position control to its midrange position.

(A)(B)

6. High-Voltage Regulation

- a. Requirement-High-voltage supply should regulate (no spot blooming) between the high and low line voltages that the Type RM561A has been designed to operate from.
- b. Set the auto-transformer for the low-line voltage 105 volts for 115 volts line voltage or 210 volts for 230 volts line voltage.
- c. Rotate the FOCUS control fully clockwise.
- d. Position the spot onto the graticule area with the positioning controls.
- e. Rotate the INTENSITY control from its normal position to its fully clockwise position.
- f. Check-For blooming (see Fig. 5-1).
- g. Return the INTENSITY control to normal position.
- h. Set the auto-transformer for the high-line voltage 125 volts for 115 volts line voltage or 250 volts for 230 volts line voltage.
- i. Rotate the INTENSITY control fully clockwise from its normal position.
- j. Check—For blooming (see Fig. 5-2).

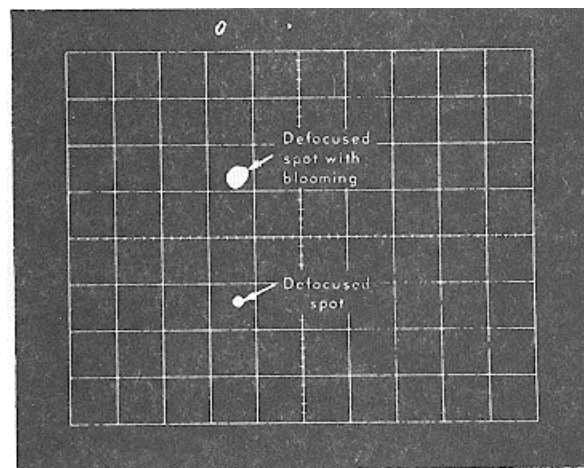

Fig. 5-2. Checking CRT display for spot blooming (high-voltage not in regulation).

- k. Return the INTENSITY control to its normal position and the auto-transformer to the design center line voltage, 115 volts or 230 volts.
- l. Readjust the FOCUS control for the best focus.

7. Vertical Geometry

- a. Requirement-The vertical display lines must not deviate more than 2 mm from being parallel to the vertical graticule lines.
- b. Set the Time/Div switch of the time base plug-in to 1 ms.

Performance Check—Type RM561A

- c. Connect a 50-ohm coaxial cable from the Type 184 Marker Out connector to the amplifier plug-in input connector.
- d. Apply 1 μ s time markers from the Type 184 and adjust the display amplitude so the time markers extend beyond the graticule limits.
- e. Adjust the vertical positioning control to move the bottom of the time marker display out of the display area.
- f. Adjust the FOCUS control for the best focus.
- g. Check—That the vertical time marker lines are within 2 mm of being parallel to the vertical graticule line. The time markers are 1 mm apart.
- h. Remove the coaxial cable.

8. Horizontal Geometry

- a. Requirement—The horizontal display lines must not deviate more than 2 mm from being parallel to the horizontal graticule lines.
- b. Set the Time/Div switch of the time base plug-in to 0.1 ms and cause the trace to free run.
- c. Set the amplifier plug-in Volts/Div switch to .5.
- d. Connect 100 mVOLTS of CALIBRATOR signal through 50-ohm coaxial cable to the input connector of the amplifier plug-in.
- e. With the vertical position control, place the display of two parallel lines to the horizontal center graticule line.
- f. With the vertical position control place the bottom line of the two-line display upon the top graticule line.
- g. Check—For not more than 2 mm of trace deviation in a horizontal distance of 10 cm. The lines of the two-line display are 2 mm apart.
- h. With the position control place the top line of the two-line display upon the bottom graticule line.
- i. Check—For not more than 2 mm of trace deviation in a horizontal distance of 10 cm. The lines of the two-line display are 2 mm apart.
- i. Disconnect the coaxial cable.

9. Focus and Astigmatism

- a. Requirement—That individual vertical time markers 1 mm apart can be distinguished within the graticule area when the FOCUS control has been properly adjusted. The FOCUS control when properly adjusted must not be at either end of adjustment range.
- b. Set the Time/Div switch time base of the plug-in to 1 ms.
- c. Apply 100- μ s time markers from the Type 184 through a 50-ohm coaxial cable to the input connector of plug-in amplifier.

- d. Adjust the display amplitude so the time markers go beyond the graticule area.
- e. Adjust the vertical position control so the bottom of the time markers is positioned out of the viewing area.
- f. Adjust the triggering controls of the time base plug-in for a stable display.
- g. Adjust the FOCUS control for the best focus throughout the graticule area.
- h. Check—That the individual vertical time markers 1 mm apart can be distinguished anywhere within the graticule area.
- i. Check—That the FOCUS control when adjusted is not at either end of its range.
- j. Remove the coaxial cable.

10. Vertical and Horizontal CRT Deflection-Plate Compensation

- a. Requirement—Optimum square corner must be obtained with the CRT Deflection Capacitance Normalizer for both the vertical and the horizontal plug-in compartments.
- b. Remove the amplifier plug-in from the left plug-in compartment.
- c. Insert the CRT Deflection Capacitance Normalizer into the left plug-in compartment.
- d. Connect 100 VOLTS of CALIBRATOR signal through a 50-ohm coaxial cable to the Capacitance Normalizer input connector.
- e. Adjust the time-base plug-in triggering controls so the leading edge of the waveform is displayed.

NOTE

The INTENSITY control may need to be advanced slightly to view the leading edge of the waveform.

- f. Check—For optimum square corner (see Fig. 5-3A).
- g. Interchange the Capacitance Normalizer and the time-base plug-in. Readjust the FOCUS control and the time-base plug-in triggering controls for a stable well focused display.
- h. Check—For optimum square corner (see Fig. 5-4).
- i. Disconnect the coaxial cable.
- j. Remove the Capacitance Normalizer. Replace the amplifier plug-in in the left compartment and the time-base plug-in in the right compartment.

(A)(B)

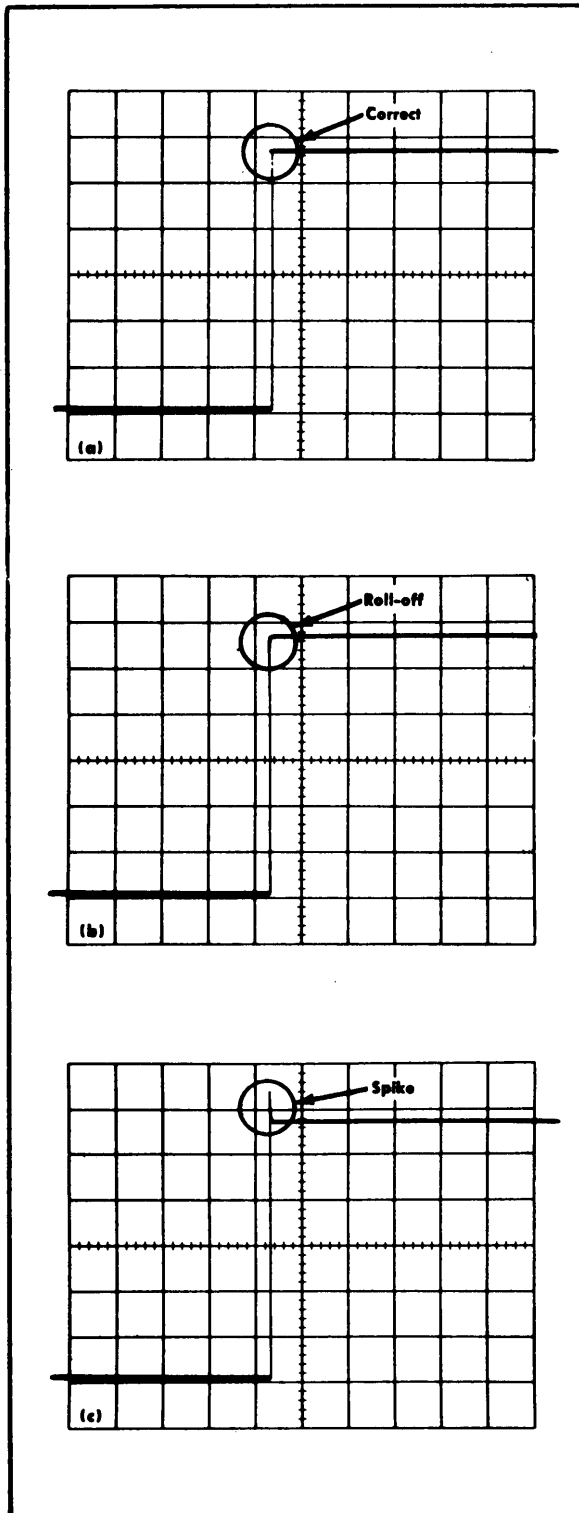

Fig. 4. (A) Typical CRT display showing correct vertical compensation adjustment, (B) and (C) Incorrect adjustment.

(A)(B)

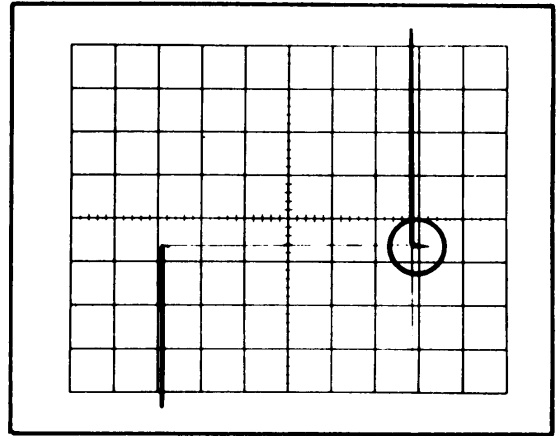

Fig. 5-4. Typical CRT display showing correct adjustment of horizontal compensation.

11. Alternate Trace and Chopped Blanking

a. Requirement—In the alternate mode two traces must show for the vertical plug-in at all sweep rates (TIME/CM switch settings).

In chopped mode the chopping transients (rising and falling portions of the waveform) must be blanked out.

NOTE

This check can only be made with an amplifier plug-in which has both alternate trace and chopped blanking provisions.

- b. Set the amplifier plug-in Mode switch to Alter.
- c. Set the amplifier plug-in Ac-Dc Gnd switches to Gnd.
- d. Position the traces about three divisions apart.
- e. Rotate the Time/Div switch of the time base plug-in throughout its range.
- f. Check—For an alternating two-trace display at all sweep rates.
- g. Set the amplifier plug-in Mode switch to Chop.
- h. Position the two traces about three divisions apart.
- i. Set the time-base plug-in Time/Div switch to display several cycles of the waveform and adjust the triggering controls for a stable display.
- j. With the CRT CATHODE SELECTOR switch in the Normal position, notice the overshoot on the display (see Fig. 5-5A).
- k. Set the CRT CATHODE SELECTOR switch to CHOPPED BLANKING.
- l. Check—That the between-channel switching transients are removed from the display (see Fig. 5-5B).
- m. Set the amplifier plug-in Mode switch to display only one channel.
- n. Set the CRT CATHODE SELECTOR switch in the Normal position.

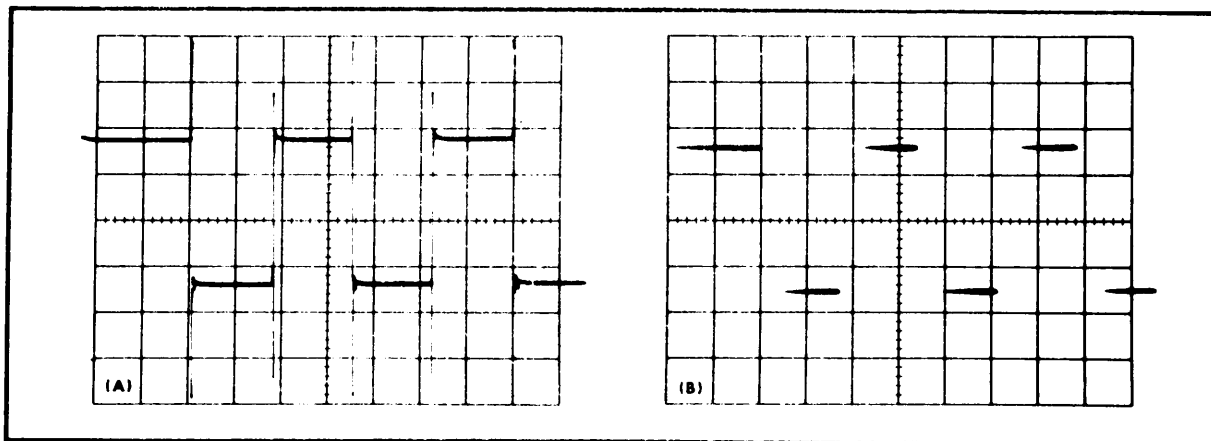

Fig. 5-5. Alternate waveform showing 1A) unblanked chopping transients and 1i5 blanked transients.

12. CRT Intensifier Circuit

a. Requirement—A portion of the trace must appear brighter (intensified) than the rest of the trace. The intensified portion of the trace should move along the trace as the delay time control is rotated.

NOTE

This check can only be made with a time-base plug-in which has delayed sweep provisions.

b. Set the time-base plug-in Time/Div switch to 1 ms and the time-base plug-in delayed sweep Time/Div switch to 0.1 ms.

c. Adjust the time-base plug-in triggering controls to produce a trace.

d. Adjust the FOCUS control and the time-base plug-in triggering controls for a well-focused free-running (or automatic triggered) trace.

e. Turn the time-base plug-in Mode switch to Intensified (not triggered).

f. Check—That an intensified portion appears on the trace (see Fig. 5-6). If the display appears only as a shortened trace, increase the INTENSITY control slightly until the complete trace, showing an intensified portion, appears.

g. Check—That as the delay time control is rotated throughout its range the intensified portion moves along the trace.

h. Set the time-base plug-in Mode switch for a normal sweep and the triggering controls for a free running trace.

13. Intensity (Z-Axis) Modulation

a. Requirement—The trace can be modulated when 10 volts or more of signal is applied to the EXT CRT CATHODE connector.

b. Remove the ground strap between the rear-panel banana jacks.

c. Set the CALIBRATOR for a 10-volt output signal.

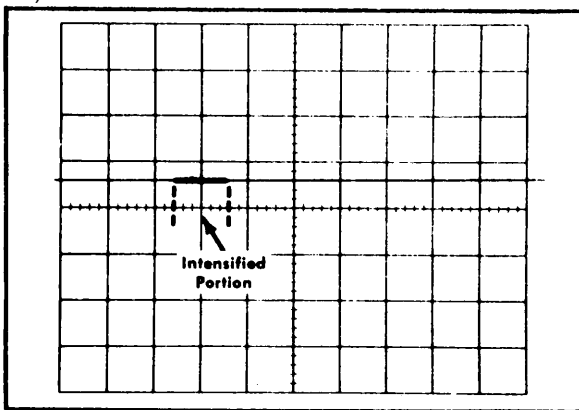

Fig. 5-6. Typical CRT display showing correct Intensifier circuit operation.

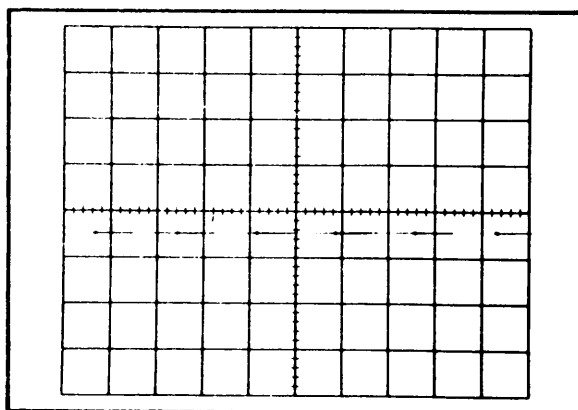

Fig. 5-7. Typical CRT display showing correct intensity modulation (time/division, 10 milliseconds).

(A)(B)

Performance Check—Type RM561A

d. Connect the CALIBRATOR signal to the EXT CRT CATHODE banana jack with the BNC-to-BNC and BNC-to-banana jack jumper leads.

e. Check—The display for intensified dots (see Fig. 5-7). It may be necessary to reduce the INTENSITY setting slightly to see the dots.

f. Remove the jumper leads and replace the ground strap.

This completes the Performance Check of the Type RM561A. Disconnect all test equipment. The plug-in amplifier and time-base plug-in are checked separately.

(A)(B)

SECTION 5A

PERFORMANCE CHECK/MAINTENANCE CALIBRATION R561B¹**Introduction**

To assure instrument accuracy, check the calibration of the Type R561B every 500 hours of operation, or every six months if used infrequently. Before complete calibration, thoroughly clean and inspect this instrument as outlined in the Maintenance section.

This section provides several features to aid in checking or calibrating this instrument. For example:

Index. The Short-Form Procedure lists the step numbers and titles of the Complete Calibration Procedure and gives the page on which each step begins. Therefore, the Short-Form Procedure can be used to locate a step in the complete procedure.

Calibration Record. The Short-Form Procedure can be reproduced and used as a permanent record of instrument calibration. Spaces are provided to check off each step as it is completed and to record performance data.

Abridged Calibration Procedure. The Short-Form Procedure lists the adjustments necessary for each step and the applicable tolerance for correct calibration. The experienced technician who is familiar with the calibration of this instrument can use this procedure to facilitate its checking or calibration.

Performance Check. The Complete Calibration Procedure can be used as a front-panel check of the instrument's performance by doing all portions except the ADJUST part of a step. When used as a performance check procedure, the instrument is checked to the original performance standards without removing the covers or making internal adjustments. Screwdriver adjustments which are accessible without removing the covers can be adjusted. Some steps are not applicable to a performance checkout procedure. These steps have a note which gives the next applicable step.

Complete Calibration. Completion of each step in the Complete Calibration Procedure checks this instrument to the original performance standards and gives the procedure to return each adjustment to its optimum setting. Limits, tolerances and waveforms in this procedure are given as calibration guides and are not instrument specifications. Where possible, instrument performance is checked before an adjustment is made. For best overall instrument performance make each adjustment to the exact setting even if the CHECK- is within the allowable tolerance.

Partial Calibration. To check or adjust only part of this instrument, start with the nearest "equipment required" picture preceding the desired portion. To prevent recalibration of other parts of the instrument

when performing a partial calibration, re-adjust only if the tolerance given in the CHECK- part of the step is not met. If an adjustment is made, any steps listed in the INTERACTION- part of the step should also be checked for correct tolerance.

TEST EQUIPMENT REQUIRED**General**

The following test equipment and accessories, or its equivalent, is required for complete calibration of the Type R561B. Specifications given are the minimum necessary for accurate calibration. Therefore, some of the recommended equipment may have specifications which exceed those given. All test equipment is assumed to be correctly calibrated and operating within the given specifications. If equipment is substituted, it must meet or exceed the specifications of the recommended equipment.

For the quickest and most accurate calibration, special Tektronix calibration fixtures are used where necessary. These special calibration fixtures are available **from the NICP.**

1. Vertical amplifier. Dual trace; bandwidth, DC to at least 10 MHz; deflection factor, 0.01 volts/division to 5 volts/division; chopped and alternate modes. Tektronix Type 3A6 Dual-Trace Amplifier recommended.

2. Time-base unit. Normal and delayed sweeps; sweep rates, one millisecond/division to one microsecond/division; 5X magnifier; single-sweep operation. Tektronix Type 383 Time-Base Unit recommended.

3. CRT deflection capacitance normalizer. (Normally required only if new cathode-ray tube has been installed or if deflection-plate compensation has been inadvertently maladjusted. Alternate method of adjustment is also given). Tektronix Calibration Fixture, 067-0500-00, recommended. (For alternate method, Tektronix Type 130 L-C Meter recommended.)

4. Variable auto-transformer. Must be capable of supplying at least 186 watts over a voltage range of 90 to 136 volts (180 to 272 volts for 230-volt nominal line). If auto-transformer does not have an AC (RMS) voltmeter to indicate output voltage, monitor output with an AC (RMS) voltmeter. For example, General Radio W10MT3W Metered Variac Auto-transformer.

5. DC volt-ohmmeter. Minimum sensitivity, 20,000 ohms/volt. For example, Triplet 630.

6. Precision DC voltmeter. Accuracy, within $\pm 0.05\%$; meter resolution, 50 microvolts; range, zero to 3.5 kilovolts. For example, Fluke Model 825A Differential DC Voltmeter (with Fluke Model 80E-5 Voltage Divider to measure the high-voltage supply).

¹For calibration procedure, see TB 750-236

(A)

Performance Check/Calibration—Type R561B

7. Test oscilloscope, with 1 X probe. (Optional, for checking power supply ripple.) Bandwidth, DC to 300 kilohertz; minimum deflection factor, five millivolts/division; accuracy, within 3%. Tektronix Type 561B with 2A63 and 2B67 plug-in units, and P6028 Probe recommended.

8. Square-wave generator. Frequency, 100 kilohertz; output amplitude, three volts to ten volts. Tektronix Type 106 Square-Wave Generator recommended.

9. Time-mark generator. Marker output, one millisecond; marker accuracy, within 0.1 %. Tektronix Type 184 Time-Mark Generator recommended.

10. Cable. Impedance, 50 ohms, electrical length, five nanoseconds; connectors, GR874. Tektronix Part No. 017-0502-00.

11. Cable, coaxial. Impedance, 50 ohms; length, 42 inches; connectors, BNC. Tektronix Part No. 012-0057-00.

12. Adapter, GR to BNC male. Tektronix Part No. 017-0064-00.

13. Adapter, BNC to banana terminal. For example, Pomona # 1269 (Tektronix Part No. 103-0090-00).

14. T connector, BNC. Tektronix Part No. 103-0030-00.

15. Termination. Impedance, 50 ohms; accuracy, $\pm 3\%$; connectors, BNC. Tektronix Part No. 011-0049-00.

16. Current-measuring probe with passive termination. Sensitivity, two milliamperes/millivolt; accuracy, within $\pm 3\%$. Tektronix P6019 Current Probe with 011-0078-00 passive termination recommended.

SHORT-FORM PROCEDURE

Type R561B, Serial No. _____
 Calibration Date _____
 Calibrated By _____

- | | | | |
|--|----------|---|-----------|
| <input type="checkbox"/> 1. Adjust -100-Volt Power Supply
-100 volts, ± 0.5 volts | Page 5-5 | <input type="checkbox"/> 7. Check Alternate Trace
Trace alternates at all sweep rates. | Page 5-7 |
| <input type="checkbox"/> 2. Check Low-Voltage Power Supplies | Page 5-5 | <input type="checkbox"/> 8. Check Dual-Trace Blanking
Switching transients (vertical lines) blanked between chopped segments. | Page 5-8 |
| <input type="checkbox"/> 3. Check Low-Voltage Power Supply
Regulation and Ripple (Optional Check) | Page 5-5 | <input type="checkbox"/> 9. Check External CRT Cathode
Intensity (Z-Axis) modulation with 3 volts input. | Page 5-9 |
| <input type="checkbox"/> 4. Adjust High Voltage
-3300 volts, ± 99 volts | Page 5-6 | <input type="checkbox"/> 10. Adjust Trace Alignment
Trace parallel to horizontal graticule lines. | Page 5-9 |
| <input type="checkbox"/> 5. Check High Voltage Regulation | Page 5-6 | <input type="checkbox"/> 11. Adjust CRT Geometry
Best overall geometry | Page 5-10 |
| <input type="checkbox"/> 6. Adjust CRT Grid Bias
Coarse intensity adjustment. | Page 5-6 | <input type="checkbox"/> 12. Check CRT Vertical Deflection Factor
18.5 to 20.5V/cm | Page 5-10 |
| | | <input type="checkbox"/> 13. Check CRT Vertical Electrical Center
Trace within 0.5 major division of graticule horizontal centerline. | Page 5-10 |
| | | <input type="checkbox"/> 14. Check CRT Horizontal Deflection
Factor 17.5 to 19.25V/cm | Page 5-10 |
| | | <input type="checkbox"/> 15. Check CRT Horizontal Electrical
Center Trace within 0.8 major division of graticule vertical centerline. | Page 5-11 |
| | | <input type="checkbox"/> 16. Check Delaying Sweep Intensification
Intensified portion on trace (with delayed sweep time-base unit). | Page 5-11 |
| | | <input type="checkbox"/> 17A. Adjust Vertical and Horizontal
Deflection-Plate Compensation Optimum square corner (or 14.3 picofarads effective capacitance). | Page 5-12 |
| | | <input type="checkbox"/> 17B. Alternate Method of Adjusting
Deflection-Plate Compensation Optimum square corner (or 14.3 picofarads effective capacitance). | Page 5-14 |
| | | <input type="checkbox"/> 18. Check and Adjust Calibrator Amplitude
+40 volts, ± 0.6 volt. | Page 5-15 |
| | | <input type="checkbox"/> 19. Check and Adjust Calibrator Repetition
Rate
One kilohertz, 10 hertz. | Page 5-16 |
| | | <input type="checkbox"/> 20. Check Calibrator Duty Factor
48% to 52% | Page 5-16 |
| | | <input type="checkbox"/> 21. Check Calibrator Rise-time
≤ 2.5 microseconds at 40 volts; ≤ 1 microsecond at all other voltages | Page 5-17 |
| | | <input type="checkbox"/> 22. Check Current Through Probe Loop
Ten milliamperes | Page 5-18 |

(A)

COMPLETE CALIBRATION PROCEDURE

General

The following procedure allows the Type R561B to be calibrated with the least interaction of adjustments and reconnection of equipment. An equipment required picture is shown for each group of checks and adjustments to identify the test equipment used. Following this picture is a complete list of front-panel control settings for the Type R561B. Controls which have been changed for the new group of checks and adjustments are printed in bold type. Each step following the test equipment picture continues from the equipment setup and control settings used in the preceding step(s) unless noted otherwise. External controls or adjustments of the Type R561B referred to in this procedure are capitalized (e.g., INTENSITY). Internal adjustment names are initial capitalized only (e.g., High Voltage).

All waveforms shown in this procedure were taken with a Tektronix Oscilloscope Camera System and Projected Graticule. The following procedure uses the equipment listed under Test Equipment Required. If equipment is substituted, control settings or equipment setup may need to be altered to meet the requirements of the equipment used. Detailed operating instructions for the test equipment is not given in this procedure. If in doubt as to the correct operation of any of the test equipment, refer to the instruction manual for that unit.

NOTE

This instrument should be calibrated at an ambient temperature of +25C, ±5C. Its performance

can be checked at any temperature within the 0°C to 50°C range. If the ambient temperature is outside the given range, see Section 1 for the applicable tolerances.

Preliminary Procedure for Performance Check Only

1. Connect the Type R561B to a power source which meets the voltage and frequency requirements of this instrument.
2. Set the POWER switch to ON. Allow at least 5 minutes warm-up before proceeding.
3. Begin the Performance Check with step 7.

Preliminary Procedure for Complete Calibration

1. Remove the top and bottom covers from the Type R561B.
2. Set the Line Selector to 115 V and the Range Selector to Medium.
3. Connect the auto-transformer to a suitable power source.
4. Connect the Type R561B to the auto-transformer output.
5. Set the auto-transformer output voltage to 115 volts.
6. Set the POWER switch to ON. Allow at least 5 minutes warm-up before proceeding.

(A)

Performance Check/Calibration—Type R561B

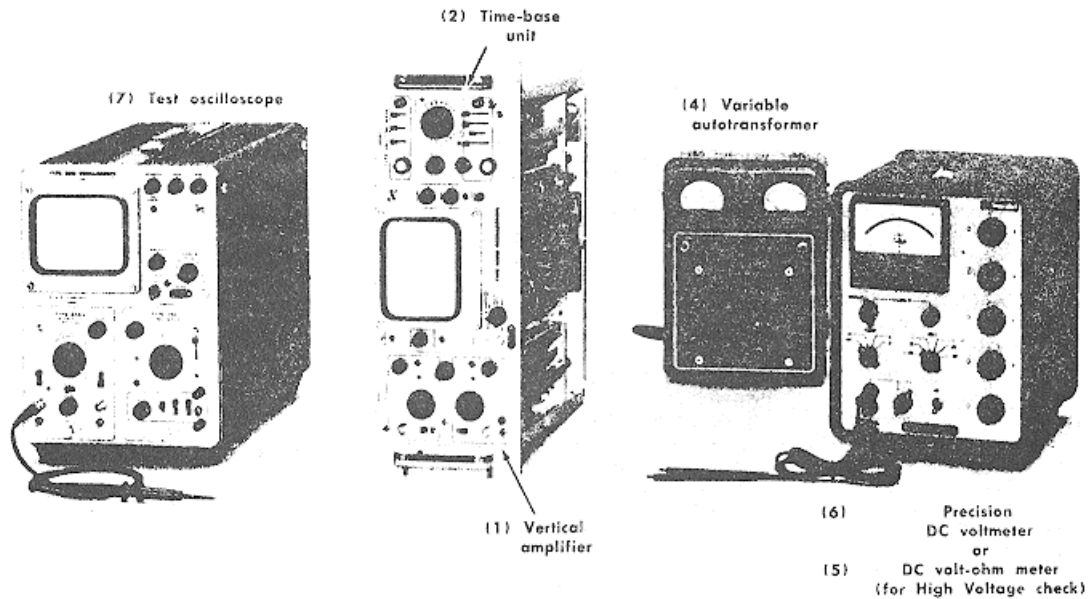

Fig. 5-1. Test equipment required for steps 1 through 6.

POWER SUPPLIES		Normal-Single Sweep	Single Sweep
Control Settings		Slope	+
Type R561B		Coupling	Auto
		Source	Int
		Level	Clockwise
INTENSITY	Counter-Clockwise	Test Oscilloscope (Optional — To check ripple)	
FOCUS	Midrange	Intensity	Nominal brightness
ASTIGMATISM	Midrange	Focus and Astigmatism	Well defined trace
SCALE ILLUM	As desired		
CALIBRATOR	OFF	Time Base	
CRT CATHODE SELECTOR	NORM	Mode	Normal
(rear panel)		Time/Div	1 ms
Vertical Amplifier Unit		Normal-Single Sweep	Norm
Ch 1 Input Coupling	AC	Level	0
Ch 1 Volts/Div	5	Slope	+
Mode	Ch 1	Coupling	Auto
Position	Centered	Source	Int
		Vertical Amplifier	
		Mode	Ch 1
Mode	Norm	Volts/Div	0.01
Time/Div	1 ms	Input Coupling	AC

1. Adjust—100-Volt Power Supply



For performance check only, proceed to step 7.

- a. Test equipment required for steps 1 through 6 is shown in Fig. 5-1. The illustrated equipment is keyed to that listed under Test Equipment Required.
- b. Connect the precision DC voltmeter between the -100-volt test point and ground (see Fig. 5-2).
- c. ADJUST—R23, -100 Volts (Fig. 5-2) for exactly -100 volts.
- d. INTERACTION—Operation of all circuits within the Type R561B is affected by the 100-volt supply.

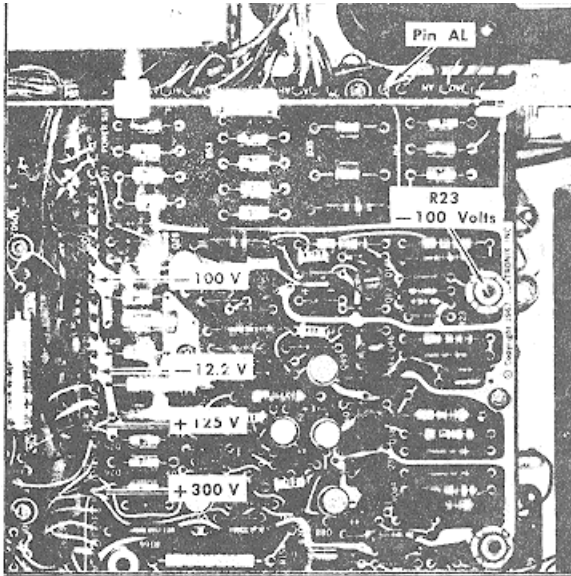

Fig. 5-2. Locations of power supply test points and R23, -100 Volts adjustment.

2. Check Low-Voltage Power Supplies

- a. Connect the precision DC voltmeter between each low-voltage test point and chassis ground. See Fig. 5-2 for test point locations.
- b. CHECK—Each supply is within the tolerance listed in Table 5-1.

TABLE 5-1

Supply	Tolerance	Maximum Line Frequency Ripple
+300 V	+295.5 to +304.5 V	5 mV
+125 V	+123.1 to 126.9 V	3 mV
-12.2 V	-12.05 V to -12.35 V	2 mV
-100 V.	-99.5 V to -100.5 V	2 mV

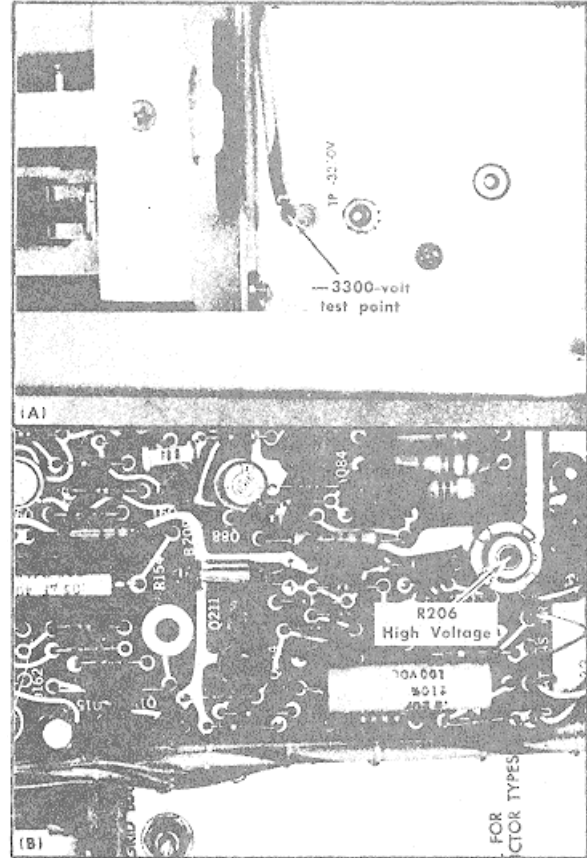

Fig. 5-3. Location of (A) -3300-volt test point, and (B) R206, High Voltage adjustment.

3. Check Low-Voltage Power Supply Regulation and Ripple (Optional Check)

- a. To check regulation, connect the precision DC voltmeter between each low voltage supply test point and chassis ground. To check ripple, connect the 1X probe from the test oscilloscope Ch 1 input connector to each test point.
- b. Set the auto-transformer output to 104 VAC
- c. CHECK—Each supply output and ripple amplitude must be within the tolerance listed in Table 5-1.

NOTE

Power supply voltage and ripple tolerances in this step are guides to correct instrument operation; not instrument performance requirements. Actual values may exceed listed tolerances with no loss in measurement accuracy if the instrument meets the performance requirements in Section 1 as tested in this procedure.

- d. Set the auto-transformer output to 126 VAC.

(A) 1

Performance Check/Calibration—Type R561B

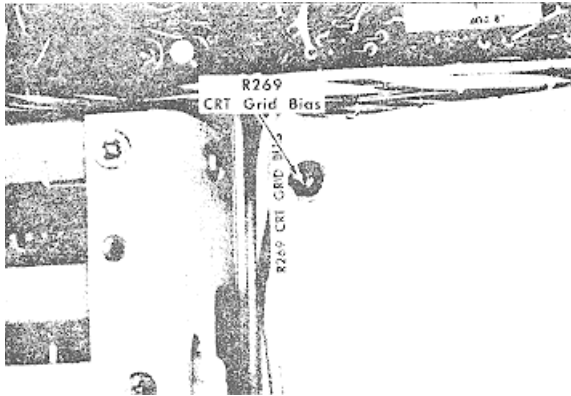

Fig. 5-4. Location of R269, CRT Grid Bias.

e. CHECK—Each supply output and ripple amplitude must be within the tolerance listed in Table 5-1.

f. Return the auto-transformer output to 115 VAC and disconnect the precision DC voltmeter and test oscilloscope.

4. Adjust High Voltage

a. Connect the DC voltmeter between ground and the -3300-volt test point (Fig. 5-3A).

b. CHECK—Meter reading must be -3300 volts, ± 99 V.

c. ADJUST—R206, High Voltage (Fig. 5-3B), for a meter reading of exactly -3300 volt,.

5. Check High Voltage Regulation (Optional Check)

a. With the DC voltmeter connected between ground and

the -3300-volt test point and the High Voltage within the limits stated in step 4b, adjust the auto-transformer for an output of 104 VAC and then 126 VAC to check the regulation of the high-voltage supply.

b. CHECK—Meter reading should not vary more than ± 15 volts when checking regulation.

c. Remove the DC voltmeter and return the auto-transformer output to 115 VAC.

6. Adjust CRT Grid Bias

a. Connect the precision DC voltmeter between pin AL of the power supply board (Fig. 5-2; this is connected to center terminal of the INTENSITY potentiometer) and ground.

b. Rotate the INTENSITY control clockwise until the meter reading is -40 volts. The knob index should be aligned with the control mid-range panel mark.

c. ADJUST—R269, CRT Grid Bias (Fig. 5-4) for a trace of medium brightness.

d. Rotate the INTENSITY control counterclockwise and observe that the trace disappears completely.

e. Disconnect the electronic voltmeter.

NOTE

The Type R561B may now be connected directly to the power source for the remainder of the procedure, provided the Line Selector and Range Selector switches are set to the proper positions for the source line voltage.

(A) 1

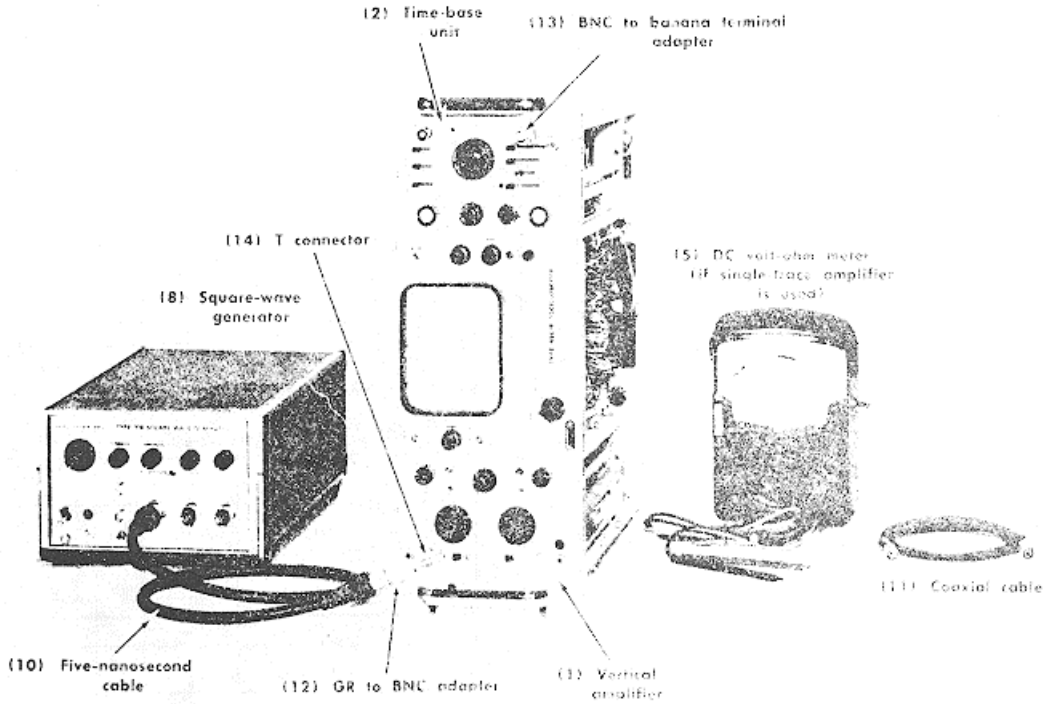

Fig. 5-5. Test equipment required for steps 2 through 16.

CRT AND DEFLECTION CIRCUITS

Control Settings

CANNOT READ TEXT

Type R561B

INTENSITY	Counterclockwise
FOCUS	Midrange
ASTIGMATISM	Midrange
SCALE ILLUM	As desired
CALIBRATOR	OFF
CRT CATHODE SELECTOR (rear panel)	NORM

Vertical Amplifier Unit

Input Coupling (Ch 1 & 2)	AC
Volts/Div (Ch 1 & 2)	5
Mode	Alter
Position (Ch 1 & 2)	Centered
Trigger	Composite (pushed in)

Time-Base Unit

Mode	Norm
Time/Div	1 ms

(A)

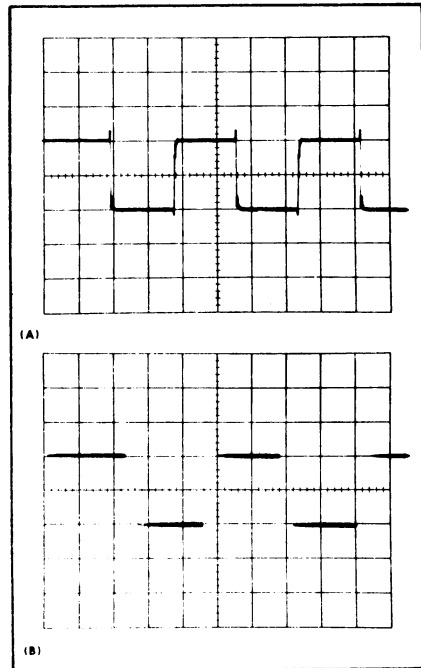

Fig. 5-6. Typical CRT displays showing correct blanking. (A) Chopped transients visible with CRT CATHODE SELECTOR switch set to NORM Time/Div 2μ s; (B) transients blanked with CRT CATHODE SELECTOR switch set to CHOPPED BLANKING.

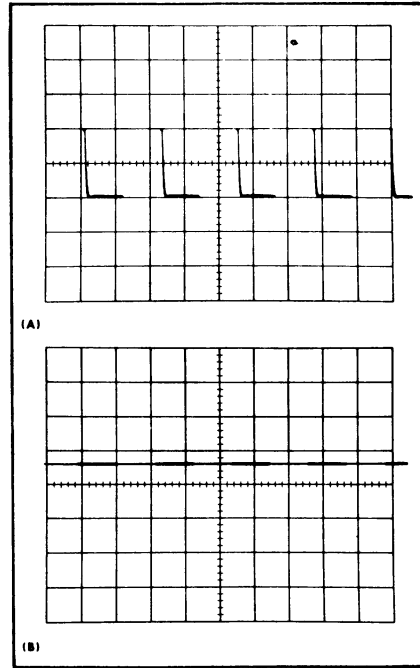

Fig. 5-7. Typical CRT displays when checking intensity modulation; (A) 10-volt signal applied to both vertical amplifier and CRT cathode. (B) 3-volt signal applied only to CRT cathode.

compartment and pin 3 of the interconnecting socket in the horizontal plug-in compartment. Also check for infinite resistance between pins 3 and 4 of the vertical plug-in unit connector. Since the Type R561B interconnects the two plug-in units in the Alternate mode, the continuity check also checks the alternate-trace function.

c. Perform the substitute procedure for single-trace units given in step 8 before re-inserting the plug-in units and applying power to the instrument.

8. Check Dual-Trace Blanking

- a. Reset the following controls:

Mode (amplifier)	Chop
Time/Div (time-base)	2μ s
- b. Position the two traces about 2 major divisions apart on the CRT screen and trigger the chopped waveform (see Fig. 5-6A) using the Triggering Level control.

c. Adjust the INTENSITY control so the vertical segments of the chopped waveform are barely visible. Adjust FOCUS and ASTIGMATISM as needed.

d. Move the CRT CATHODE SELECTOR switch to CHOPPED BLANKING.

e. CHECK-The vertical segments should now be blanked and the horizontal segments should be slightly intensified. (See Fig. 5-6B.)

f. Return the CRT CATHODE SELECTOR switch to NORM.

If a single-trace amplifier plug-in unit is used:

a. (With power off and amplifier plug-in unit removed), connect the ohmmeter between pin 24 of the interconnecting socket in the vertical plug-in compartment and the wire strap that diagonally connects the inboard terminals of switch SW255 (CRT CATHODE SELECTOR)

b. CHECK-Meter reading is infinity (open circuit) with the CRT CATHODE SELECTOR switch in the NORM and EXT INPUT positions.

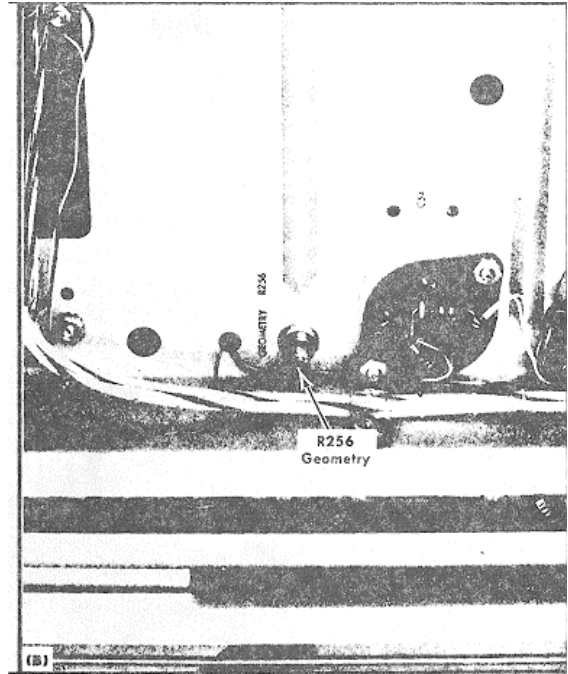
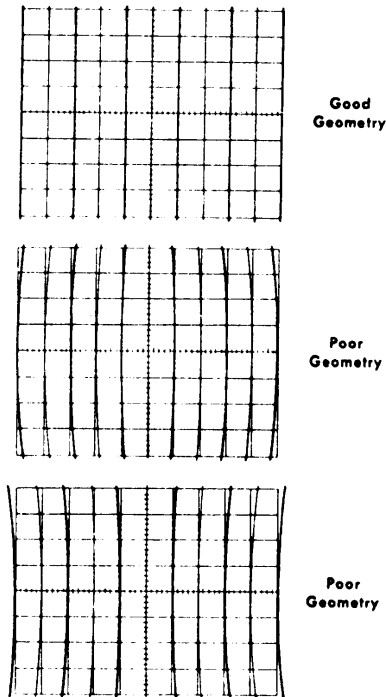

Fig. 5-8. (A) Idealized waveforms showing good geometry with examples of poor geometry; (B) location of R256, Geometry.

c. Set the CRT CATHODE SELECTOR to CHOPPED BLANKING.

d. CHECK-Meter reading is zero ohms (closed circuit). Together with the following external-cathode intensity modulation check, this continuity check tests the chopped blanking function of the Type R561B.

e. Disconnect the ohmmeter and set the CRT CATHODE SELECTOR to NORM.

f. Re-insert the plug-in units into the Type R561B.

g. Set the POWER switch to ON and allow five minutes for the instrument to warm up.

9. Check External CRT Cathode

a. Change the following control settings:

Mode (Vertical Amplifier)	Ch 1
Time/Div (Time-Base)	5 μ s

b. Connect the square-wave generator high amplitude output to the amplifier unit Ch 1 input connector through a 5-nanosecond GR cable and BNC T connector (use a GR to BNC adapter to connect the GR cable to the T connector). Connect a coaxial cable from the T connector to the EXT INPUT connector at the rear of the Type R561B.

c. Set the square-wave generator for a two-division CRT display (10 volts peak to peak) at 100 kilohertz. Adjust the Triggering Level control for a stable display.

d. Decrease the intensity until the waveform is barely visible.

e. Set the CRT CATHODE SELECTOR to EXT INPUT.

f. CHECK--The top portions of the waveform should be blanked completely and the bottom portions should be intensified (see Fig. 5-7A).

g. Set the CRT CATHODE SELECTOR to NORM and the amplifier Volts/Div switch to 1.

h. Adjust the square-wave generator amplitude to produce a three-division CRT display (3 volts peak to peak). Use an attenuator if necessary.

i. Move the signal lead from the amplifier Ch 1 input to the time-base Ext Trig input (use a BNC to banana terminal adapter). Do not remove the signal from the EXT INPUT connector.

j. Set the time-base Source switch to Ext and the CRT CATHODE SELECTOR to EXT INPUT. Trigger the display.

k. CHECK--Intensity modulation should be visible with the 3-volt signal applied (see Fig. 5-7B).

l. Remove the square-wave generator signal.

10. Adjust Trace Alignment

a. Change the following control settings:	
INTENSITY	Normal display brightness
CRT CATHODE SELECTOR	NORM

(A)

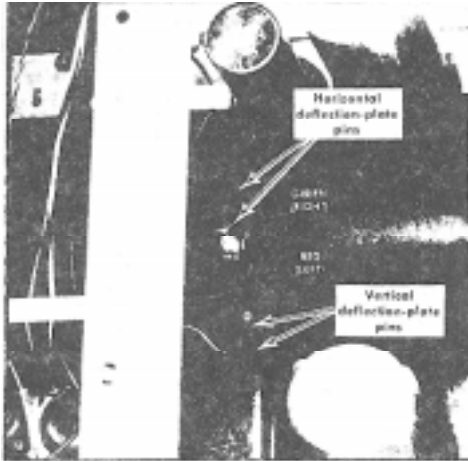

Fig. 5-9. Location of vertical and horizontal deflection-plate neck pins.

- i. Position the trace to the top graticule line.
- j. CHECK-Deviation from straight line should not exceed 0.1 division.

For Performance Check only, proceed to step 16.

12. Check CRT Vertical Deflection Factor

This step is not applicable to Performance Check.

- a. Connect the DC voltmeter (set to 300 volt scale between the two vertical deflection plate neck pins (BLUE and BROWN leads, see Fig 5-9.) Do not short to the CRT shield.
- b. Position the trace to the top graticule line.
- c. Note and record the meter reading.
- d. Remove the meter leads and position the trace to the bottom graticule line.
- e. Reconnect the DC voltmeter between the two vertical deflection plate neck pins, opposite in polarity to the connection in step a.
- f. Again note and record the meter reading.
- g. Determine the voltage swing over the eight major divisions by adding the meter reading noted in step c to the meter reading noted in step f.
- h. CHECK--Voltage swing over eight major divisions is between 148 and 164 volts. This indicates a vertical deflection factor of 18.5 to 20.5 volts per division.

13. Check CRT Vertical Electrical Center

This step is not applicable to Performance Check.

- a. With the DC voltmeter connected between the vertical deflection-plate neck pins, position the trace towards graticule center while observing the meter. Continue to position the trace until the meter reading is zero volts. This is the CRT vertical electrical center:
- b. CHECK- Trace must be within 0.5 major division of the graticule centerline.
- c. Disconnect the DC voltmeter.

14. Check CRT Horizontal Deflection Factor

This step is not applicable to Performance Check.

- a. Rotate the INTENSITY control fully counterclockwise.
- b. Remove the two plug in units, then insert the time-base plug-in unit into the vertical (left) compartment and the amplifier unit into the horizontal (right) compartment.
- c. Allow about 1/2 minute warmup, then increase the intensity to normal brightness and note the trace is now vertical.
- d. Connect the DC voltmeter (set to 300-volt scale) between the two horizontal deflection plate neck pins (GREEN anti RED leads, see Fig. 5-9).

- | | |
|-------------------------------|-----------|
| Time/Div (time-base) | 1 ms |
| Triggering Level (time base) | Clockwise |
| Triggering Source (time-base) | Int |
- b. Position the trace to the horizontal centerline
 - c. CHECK--Trace should be parallel to the horizontal graticule lines. If necessary, adjust the TRACE ALIGNMENT adjustment front panel to align the trace to the horizontal graticule line.

11. Adjust CRT Geometry ❶

- a. Connect the time-mark generator marker output to the amplifier Ch 1 input connector with a coaxial cable.
- b. Set the time-mark generator for 1 millisecond markers.
- c. Trigger the display, with the Triggering Level control and position the display baseline to a point below the bottom edge of the graticule.
- d. Set the Volts/Div switch so that the time markers over-scan the graticule area.
- e. ADJUST R256. Geometry (Fig 58B), for minimum bowing of markers at the left and right edges of the graticule.
- f. CHECK- Deviation from straight line should not exceed 0.1 division (see Fig. 5 8A).
- g. Remove the time mark signal and position the trace to the bottom graticule line.
- h. CHECK-Deviation from straight line should not exceed 0.1 division.

- e. Position the trace to the left edge of the graticule.
- f. Note and record the meter reading.
- g. Remove the meter leads and position the trace to the right edge of the graticule.
- h. Reconnect the DC voltmeter between the horizontal deflection-plate neck pins, opposite in polarity to the connection in step d.
- i. Again note and record the meter reading.
- j. Determine the voltage swing over the ten major divisions by adding the meter reading noted in step f to the meter reading noted in step i.
- k. CHECK-Voltage swing over ten major divisions is between 175 and 192.5 volts. This indicates a horizontal deflection factor of 17.5 to 19.25 volts per division.

15. Check CRT Horizontal Electrical Center

This step is not applicable to Performance Check.

- a. With the DC voltmeter connected between the horizontal deflection-plate neck pins, position the trace towards graticule center while observing the meter. Continue to position the trace until the meter reading is zero volts. This is the CRT horizontal electrical center.
- b. CHECK-Trace must be within 0.8 major division of the graticule vertical centerline.
- c. Disconnect the DC voltmeter.
- d. Rotate the INTENSITY control fully counterclockwise.
- e. Remove the plug-in units, then re-insert the amplifier unit into the vertical (left) compartment and the time-base unit into the horizontal (right) compartment. Allow about 1/2 minute warmup.

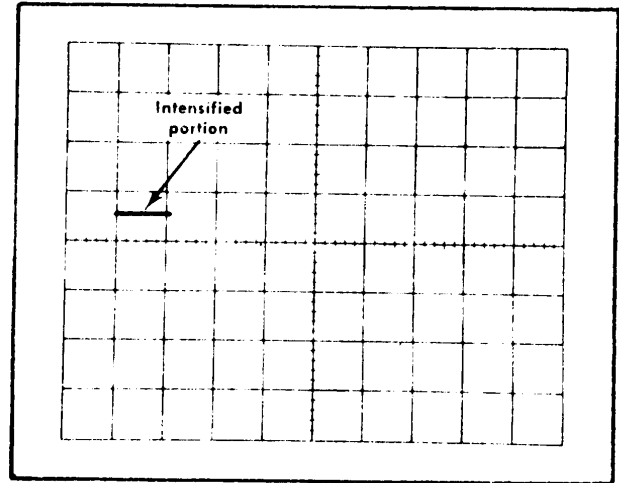

Fig. 5-10. Typical CRT display showing correct intensifier circuit operation.

16. Check Delaying Sweep Intensification

- a. Set the time-base Delayed Sweep Time/Div switch to 0.1 ms and the Delay Time dial to 1.00. Position the display as needed.
- b. Switch the time-base Mode switch to Intensified (not Trig Intensified).
- c. CHECK-It should be possible to adjust the INTENSITY control so that only the intensified portion of the delaying (normal) sweep is visible on the CRT screen. See Fig. 5-10.

For Performance Check only, proceed to step 18.

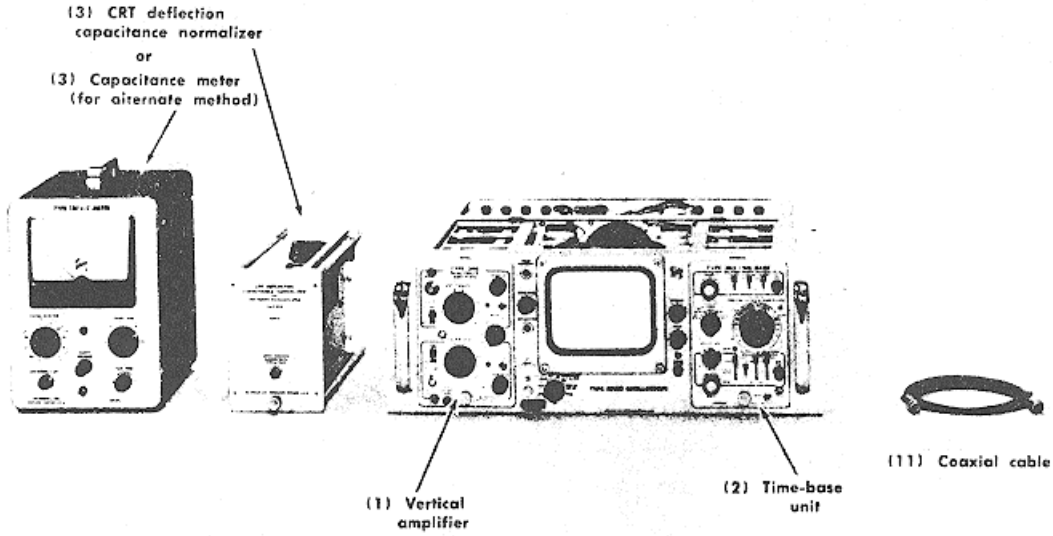

Fig. 5-11. Test equipment required for step 17.

DEFLECTION-PLATE COMPENSATION

Control Settings

Type R561B

INTENSITY	Counterclockwise
FOCUS	Well-defined trace
ASTIGMATISM	Well-defined trace
SCALE ILLUM	As desired
CALIBRATOR	OFF
CRT CATHODE SELECTOR (rear panel)	NORM

Vertical Amplifier Unit

Input Coupling (Ch 1 & 2)	AC
Volts/Div (Ch 1 & 2)	5
Mode	Ch 1
Position	Centered

Time-Base Unit

Mode	Norm
Time/Div	0.1 ms
Normal-Single Sweep	Norm
Slope	---

Coupling
Source
Level

Auto
Int
Clockwise

17A. Adjust Vertical and Horizontal Deflection-Plate Compensation

①

Omit this step unless the CRT has been replaced.

- a. Test equipment required for step 17 is shown in Fig. 5-11. The illustrated equipment is keyed to that listed under Test equipment Required.
- b. Remove the vertical amplifier plug-in unit and insert the CRT Deflection Capacitance Normalizer into the left plug-in compartment.
- c. Connect a coaxial cable from the CAL OUT connector to the Capacitance Normalizer input connector.
- d. Set the CALIBRATOR switch to 40 V.
- e. Increase the intensity to normal display brightness and adjust the Triggering Level control for a stable display.

(A)

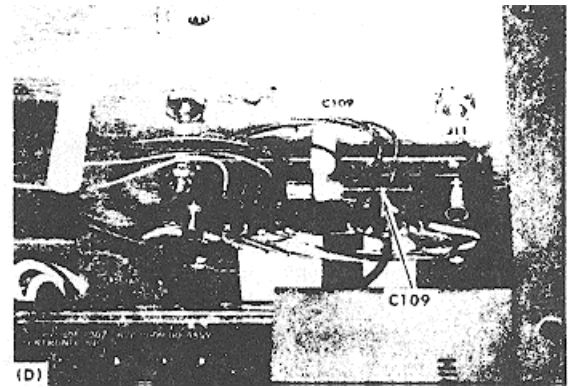
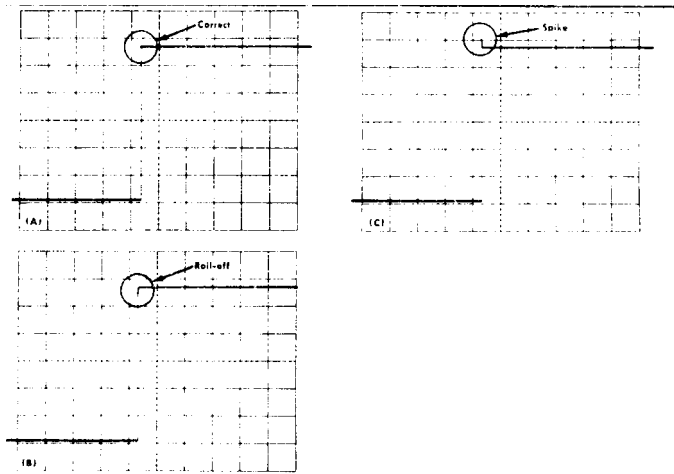

Fig. 5-12 (A) Typical CRT display showing correct vertical compensation adjustment; (B) and (C) incorrect adjustment, (D) location of C109 (left side).

- f. Turn the 51/2 Magnifier on and position the leading edge of the square wave as shown in Fig. 5.12A.
- g. ADJUST - C109 (Fig. 5-12) for optimum square corner.
- h. Rotate the INTENSITY control counterclockwise and interchange the Capacitance Normalizer and time-base unit. Readjust the INTENSITY, FOCUS and time-base triggering controls for a stable well-focused display.

- i. ADJUST--C102 (Fig. 5-13B) for optimum square corner. See Fig. 5-13A.
- j. Turn the 5X Magnifier off and rotate the INTENSITY control counter clockwise.
- k. Remove the Capacitance Normalizer. Replace the amplifier unit in the left compartment and the time-base unit in the right compartment.

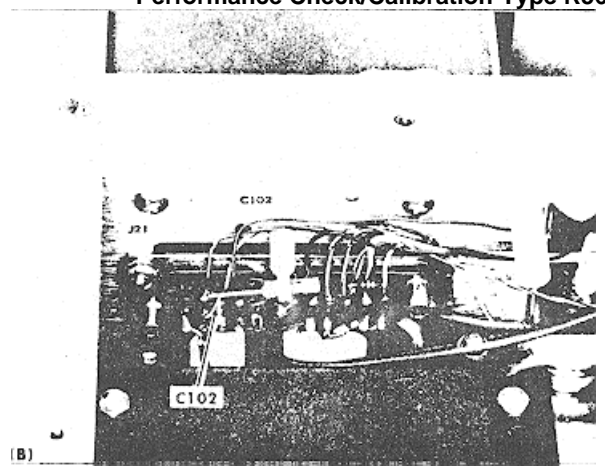
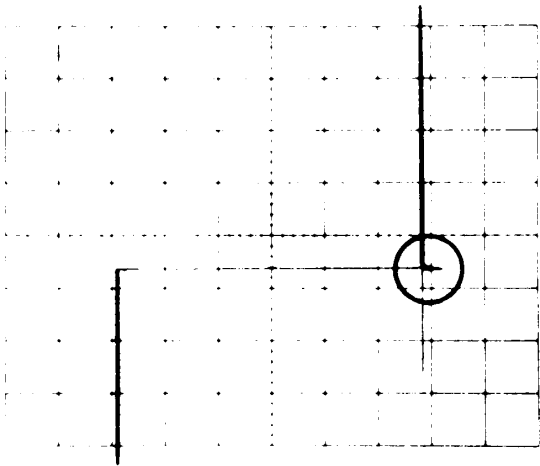

Fig. 5-13. (A) Typical CRT display showing correct adjustment of horizontal compensation; (B) location of C102 (right side).

17B. Alternate Method of Adjusting Deflection-Plate Compensation

NOTE

The following method can be used to adjust the deflection-plate compensation if a Capacitance Normalizer is not available.

The effective deflection-plate capacitance of the CRT is the capacitance seen by the plug-in unit when the deflection plates are driven push-pull. Therefore, it cannot be measured directly with a capacitance meter. However, the individual circuit capacitances which make up the effective deflection plate capacitance can be measured. These individual circuit capacitances are shown schematically in Fig. 5-14. C1 and C2 represent the capacitance from each deflection plate to ground. C3 represents the variable capacitance

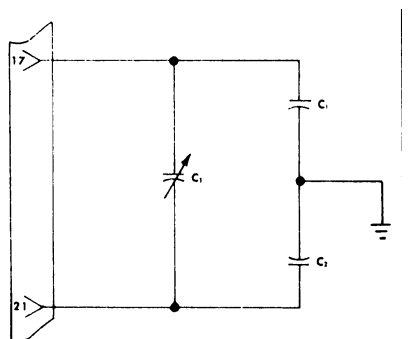

Fig. 5-14. Schematic representation of the effective CRT deflection-plate capacitance.

between the deflection plates. The variable capacitor is made up of the circuit capacitance, plus the capacitor added for adjustment.

The effective deflection-plate capacitance, C_{eff} can be expressed in terms of C1, C2 and C3 as follows:

$$C_{eff} = \frac{C1 + C2}{2} + 2(C3)$$

Setting C_{eff} equal to 14.3 picofarads (value set at factory), the value of the variable capacitor can be calculated.

$$C3 = 7.15 \text{ pF} - \frac{C1 + C2}{4}$$

- a. Disconnect the power cord and isolate the Type R551B from ground.
- b. Remove both plug-in units.
- c. Connect the capacitance meter guard voltage to pin 21 of the vertical (left) plug-in compartment and measure the capacitance between pin 17 and the oscilloscope chassis. This is C1.
- d. Connect the capacitance meter guard voltage to pin 17 and measure the capacitance between pin 21 and the oscilloscope chassis. This is C2.
- e. Substitute the measured capacitance values into the equation and solve for C3.
- f. Connect the guard voltage to the oscilloscope chassis and measure the capacitance between pins 17 and 21.
- g. Adjust C109 until the measured capacitance equals the value calculated for C3 in step e.
- h. Repeat steps c through g for the horizontal (right) plug-in compartment. Adjust C102 for the calculated value of C3.
- i. Remove the capacitance meter.
- j. Replace the plug-in units removed in step b and reapply power to the instrument. Allow about five minutes warmup before continuing.

(A)

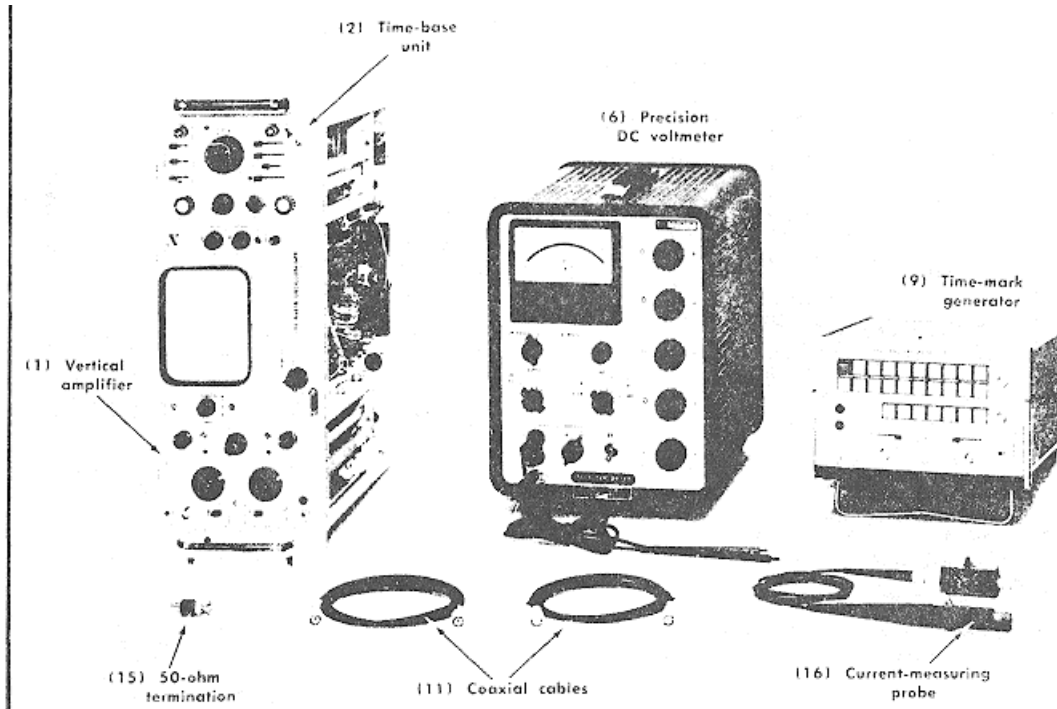

Fig 5-15. Test equipment required for steps 18 through 22.

1 kHz CALIBRATOR

Slope +
Coupling Auto
Source Int
Level Clockwise

Control Settings

Type R561B

INTENSITY	Normal brightness
FOCUS	Well defined trace
ASTIGMATISM	Well defined trace
SCALE ILLUM	As desired
CALIBRATOR	10 mA DC (40 V DC)
CRT CATHODE SELECTOR	NORMA

(rear panel)

18. Check and Adjust Calibrator Amplitude

- a. Test equipment required for steps 18 through 22 is shown in Fig. 5-15. The illustrated equipment is keyed to that listed under Test Equipment Required.
- b. Connect the differential voltmeter between ground and the CAL OUT connector.

For Performance Check only:

CHECK--- Meter reading is --+40 volts, $\pm 0.6V$. Proceed to step 19.

- c. ADJUST--R166, Amplitude (Fig. 5-16) for meter reading of exactly +40 volts.
- d. Remove Q159 (Fig. 5-16) and check the remaining calibrator voltages as listed in Table 5-2. Connect a 50 ohm termination to the CAL OUT connector when checking the 0.2 V, 20 mV and 2 mV positions of the CALIBRATOR switch.
- e. Set the CALIBRATOR witch to OFF.
- f. Replace Q159 and remove the Differential Voltmeter

Vertical Amplifier

Input Coupling (Ch 1 & 2)	DC
Volts/Div (Ch 1)	2
Volts/Div (Ch 2)	.5
Mode	Alter
Position (both)	Centered

Time-Base

Mode	Norm
Time/Div	1 ms
Normal-Single Sweep	Norm

(A)

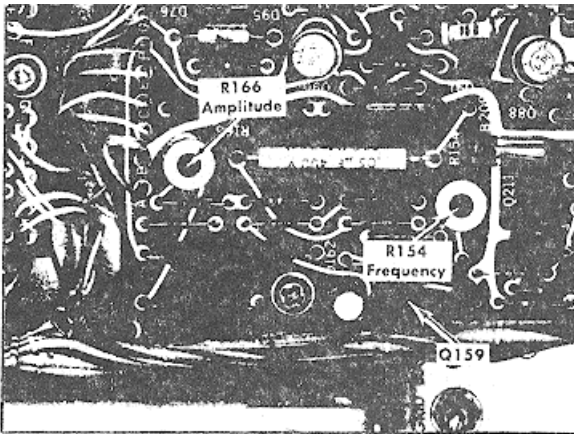

Fig. 5-16. Location of Calibrator controls.

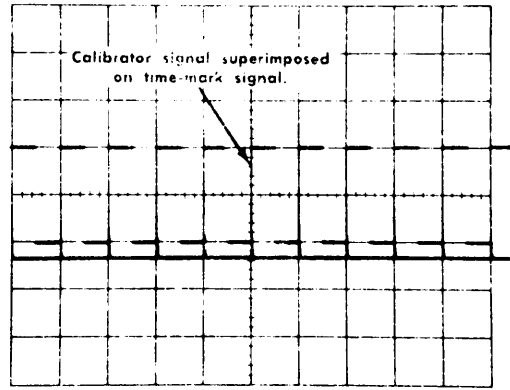

Fig. 5-17. Typical CRT display showing correct calibrator repetition rate.

TABLE 5-2

Calibrator	Meter Reading
40 V	+40V, $\pm 0.6V$
4V	+4V, $\pm 0.06 V$
0.4 v	+0.4 V, $\pm 6 mV$
40 mV	+40 mV, $\pm 0.6 mV$
40 mV	-+4 mV, $\pm 0.06 mV$
Into 50 Ω (tolerance within 3%)	
0.2 V	+0.2 mV, $\pm 4.5%$
20 mV	+2 mV, $\pm 4.5%$
2 mV	+2 mV, $\pm 4.5%$

19. Check and Adjust Calibrator Repetition Rate

- Connect the CAL OUT connector to the Ch 1 input connector with a coaxial cable.
- Set the CALIBRATOR to 4 V.
- Connect the time-mark generator marker output connector to the Ch 2 input connector with a coaxial cable.
- Set the time-mark generator for one-millisecond markers.
- Position the display so that the square-wave calibrator signal is superimposed on the time-mark signal. Adjust the Triggering Level control for a stable display.
- Adjust the time-base Sweep Cal (front panel) for one time marker each major division, and adjust the amplifier Calib control (front panel) for exactly two major divisions of calibrator signal amplitude.

For Performance Check only:

CHECK--One cycle of calibrator waveform for each marker (see Fig 5-17). The error in 10 major divisions must be ≤ 0.5 minor divisions (the positive transition of the square wave at the right hand edge of the graticule must be no more than 0.5 minor divisions (1 mm) from the positive transitions of the corresponding time marker. **Disconnect the time -mark generator and proceed to step 20.**

- ADJUST--R154, Frequency (Fig. 5-16), for one cycle of calibrator waveform for each marker. See Fig. 5-17 (Since the sweep was calibrated in step 4, the display should also be one cycle of calibrator waveform for each major division.)
- Position the leading edge of the tenth cycle of calibrator waveform to the center of the graticule and turn the 5X Magnifier on.
- Make final adjustment of the Frequency control by aligning the positive-going transition of the square wave with the positive-going transition of the time marker.
- Turn the 5>X Magnifier off and position the sweep start to the left edge of the graticule.
- Disconnect the time-mark generator.

20. Check Calibrator Duty Factor

- Change the following control settings:

Mode (amplifier unit)	Ch 1
Volts/Div (amplifier unit)	1
Time/Div (time-base unit)	0.1 ms
- Center the display vertically with the Ch 1 Position control.
- Set the Triggering Level control so the display starts on the rising portion of the waveform.
- Turn the 5X Magnifier on.
- Position the 50% point on the falling edge of the calibrator waveform to the center vertical line.
- Set the Triggering Slope to

(A)

g. CHECK-50% point on the rising edge is now displayed not more than two divisions from the center vertical line (indicates a duty factor of 48% to 52%; see Fig. 5-18).

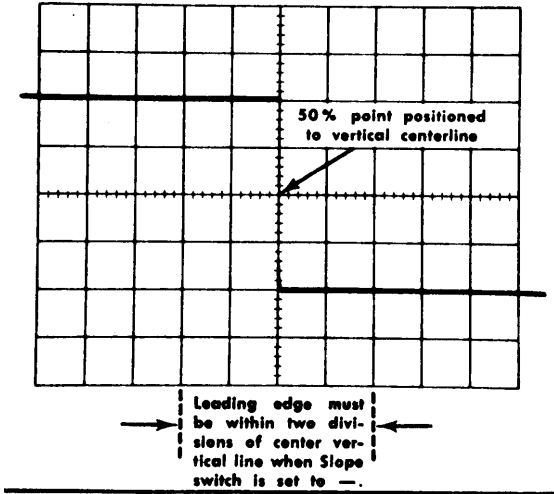

Fig. 5-18. Typical CRT display when checking calibrator duty cycle.

21. Check Calibrator Risetime

a. Change the following control settings:

Volts/Div	0.5
5 X Mag	Off
Time/Div (Normal Sweep)	0.5 ms
Time/Div (Delayed Sweep)	1 μ s
Triggering Slope	+

b. Adjust the amplifier unit Variable Volts/Div control (concentric with Volts/Div switch) for exactly 5 divisions of vertical display.

c. Set the time-base Mode switch to Intensified and adjust the Delay Time dial to brighten the leading edge of the second cycle of display (approximately 2.00).

d. Set the time-base Mode switch to Delayed Sweep.

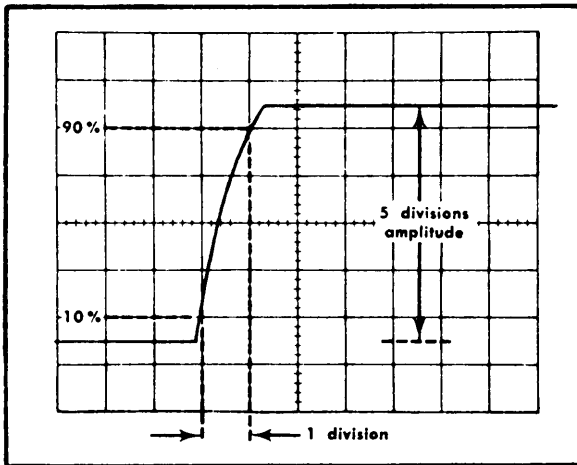

Fig. 5-19. Idealized waveform showing maximum allowable calibrator risetime at sweep rate of 1 μ s/division.

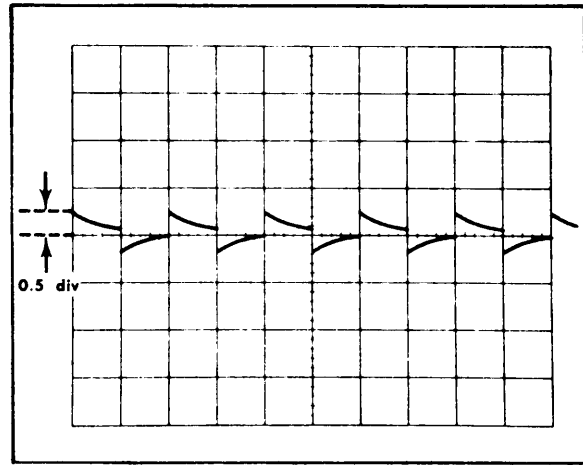

Fig. 5-20. Typical CRT display when checking calibrator current.

- e. Position the 10% point on the leading edge to a vertical graticule line. It may be necessary to increase the intensity slightly to see the leading edge.
- f. CHECK-CRT display for one division or less between the 10% and 90% points on the leading edge of the calibrator waveform (one microsecond, or less, risetime); see Fig. 5-19
- g. Set the time-base Mode switch to Norm, amplifier Volts/Div switch to 5 and the CALIBRATOR switch to 40V.
- h. Repeat steps b through e to obtain the leading-edge display of the 40-volt calibrator waveform.
- i. CHECK-CRT display for 2.5 divisions or less between the 10% and 90% points on the leading edge of the calibrator waveform (2.5 microseconds, or less, risetime).
- j. Disconnect the coaxial cable.

22. Check Current through Probe Loop

- a. Change the following control settings:

CALIBRATOR	10 mA
Mode (time-base)	Norm
Volts/Div	0.01 (Calibrated)

- b. Connect the current-measuring probe and passive termination to the Ch 1 input connector. Set the passive termination for a sensitivity of 2 mA/mV.
- c. Clip the current probe around the probe loop on the front panel.
- d. Position the display vertically so the amplitude of the square-wave current can be measured.
- e. CHECK-CRT display is 0.5 division in amplitude (ten milliamperes; see Fig. 5-20).

NOTE

This step checks for the presence of current in the probe loop. This current will remain within the stated 1% accuracy due to the tolerance of the divider resistors and tolerance of the calibrator output voltage. If it is necessary to verify the accuracy of the calibrator current, use a current measuring meter with an accuracy of at least 0.25%.

- f. Disconnect all test equipment. This completes the calibration procedure for the Type R561B Oscilloscope.

SECTION 6
MAINTENANCE CALIBRATION RIV1561A⁵

Introduction

Complete calibration information for the Type RM561A is given in this section. This procedure checks the instrument against the performance requirements listed in the Characteristics section. The Type RM561A can be returned to original performance standards by completion of each step in this procedure. If it is desired to merely touch up the calibration, perform only those steps entitled "Adjust ...". A short-form calibration procedure is also provided in this section for the convenience of the experienced calibrator. It may also be used as a calibration record or as an index to the steps in the complete Calibration Procedure. The Type RM561A should be checked, and recalibrated if necessary, after 500 hours of operation, or every six months if used infrequently, to assure correct operation and accuracy.

EQUIPMENT REQUIRED

The following test equipment (shown in Figs. 6-1 and 6-2), or its equivalent, is required for complete calibration of the Type RM561A. Specifications given are the minimum necessary for accurate calibration of this instrument. All test equipment is assumed to be correctly calibrated and operating within the given specifications. If equipment is substituted, it must meet or exceed the specifications of the recommended equipment.

For the quickest and most accurate calibration, special calibration fixtures are used where necessary. All calibration fixtures listed here can be obtained from Tektronix, Inc. Order by part number through your local Tektronix Field Office or representative.

1. Tektronix 2- or 3-series amplifier plug-in unit.¹
2. Tektronix 2- or 3-series time base plug-in unit.¹
3. DC voltmeter. Minimum sensitivity, 20,000 ohms/volt; accuracy, checked to 1% at -100 volts, -12.2 volts, +125 volts and +300 volts and $\pm 3\%$ at ± 3300 volts. For example, Simpson Model 262.²
4. Variable autotransformer. Must be capable of supplying at least 350 volt-amperes over a voltage range of 105 to 125 volts (210 to 250 volts for 230-volt nominal line). For example, General Radio W10MT3W Metered Variac Autotransformer.³

¹Use maximum performance plug-in units. For example, use a high-frequency unit in preference to low-frequency, dual-trace rather than single-trace, etc.

²When used with sampling plug-in units. The Type RM561A low-voltage power supplies must be adjusted to 0.5% or better for correct plug-in operation. Use a DC voltmeter with accuracy better than 0.05 %.

³Used only to check power-supply regulation and ripple in steps 6 and 7. May be deleted from list if these checks are not performed.

⁵For calibration procedure, see TB 750-236

5. Test oscilloscope. Frequency response, 100MHz; minimum deflection factor, 0.005 volts/division. Tektronix 530-, 540-series Oscilloscope with Type B Plug-In Unit or Tektronix Type 561A/RM with Type 3A1 and 2A63 Amplifier Plug-Ins and Type 3B4 Time-Base Plug-In recommended.

6. CRT deflection capacitance normalizer. Tektronix Calibration Fixture 067-0500-00 recommended.⁴

7. Standard amplitude calibrator. Amplitude accuracy, 0.25%; signal amplitude, 0.2 millivolts to 100 volts; output signals, 1-kHz square-wave and +DC. Tektronix Calibration Fixture 067-0502-00 recommended.

8. Termination. Impedance, 50-ohm; connectors, GR; accuracy, $\pm 0.1\%$. Tektronix Calibration Fixture 067-0515-00.

9. 1X probe. BNC Connector. Tektronix P6028 Probe. 10. Cable (three). Impedance, 50-ohm; connectors, BNC. Tektronix Part No. 012-0057-00.

11. Patch cord. Length, 18 inches; connectors, BNC-to-banana plug. Tektronix Part No. 012-0091-00.

12. Patch cord. Length, 18 inches; connectors, BNC-to-BNC. Tektronix Part No. 012-0087-00.

13. Adjustment tool. Insulated screwdriver, non-metallic. Tektronix Part No. 003-0000-00.

14. Adapter. GR to BNC female. Tektronix Part No. 017-0063-00.

15. Adapter. GR to BNC male. Tektronix Part No. 017-0064-00.

16. Jumper lead (not shown). Length, 6 inches; connectors, insulated alligator clips. Not available from Tektronix.

CALIBRATION RECORD AND INDEX

This short-form calibration procedure is provided to aid in checking the operation of the Type RM561A. It may be used as a calibration guide by the experienced calibrator, or it may be used as a record of calibration. Since the step numbers and titles used here correspond to those used in the complete Calibration Procedure, this procedure also serves as an index to locate a step in the complete Calibration Procedure. Performance requirements correspond to those given in the Characteristics section.

Type RM561A, Serial No. _____

Calibration Date _____

Calibration Technician _____

⁴Normally required only if new cathode-ray tube has been installed or if deflection-plate compensation has been inadvertently misadjusted. An alternative method of adjustment is also given in step 16b.

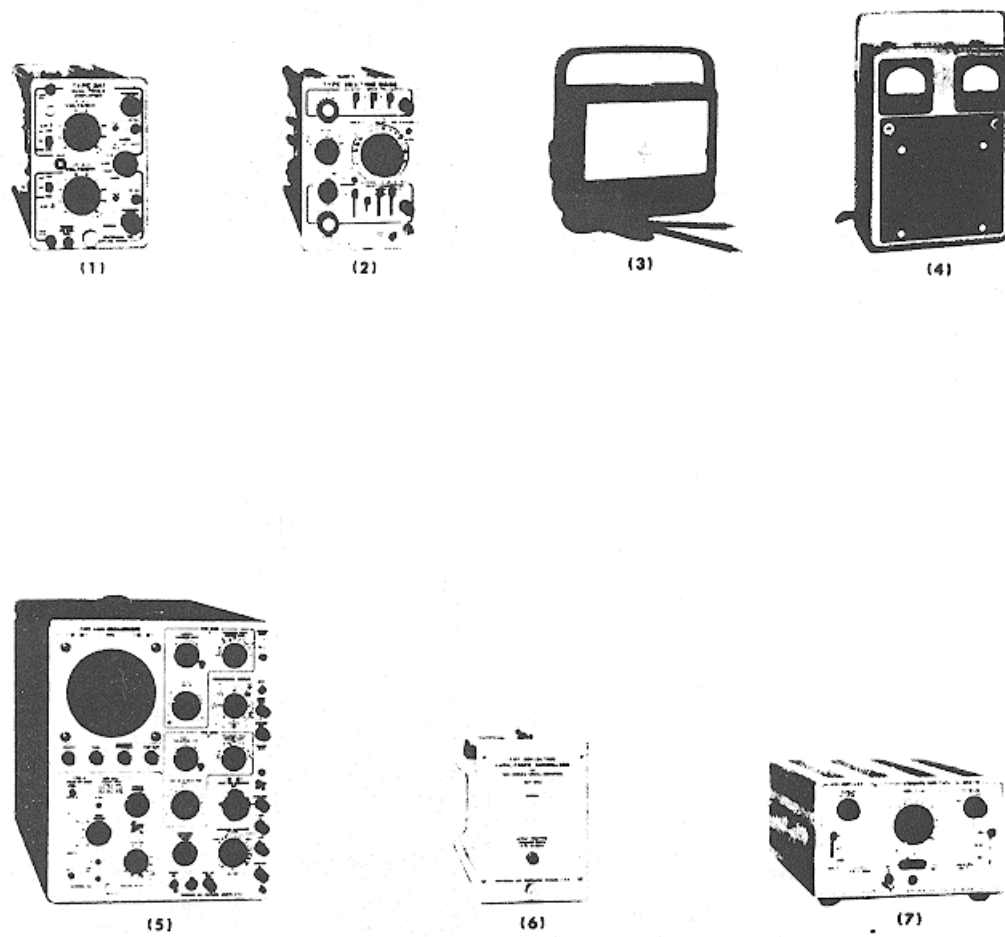

Fig. 6-1. Recommended calibration equipment, items 1 through 7.

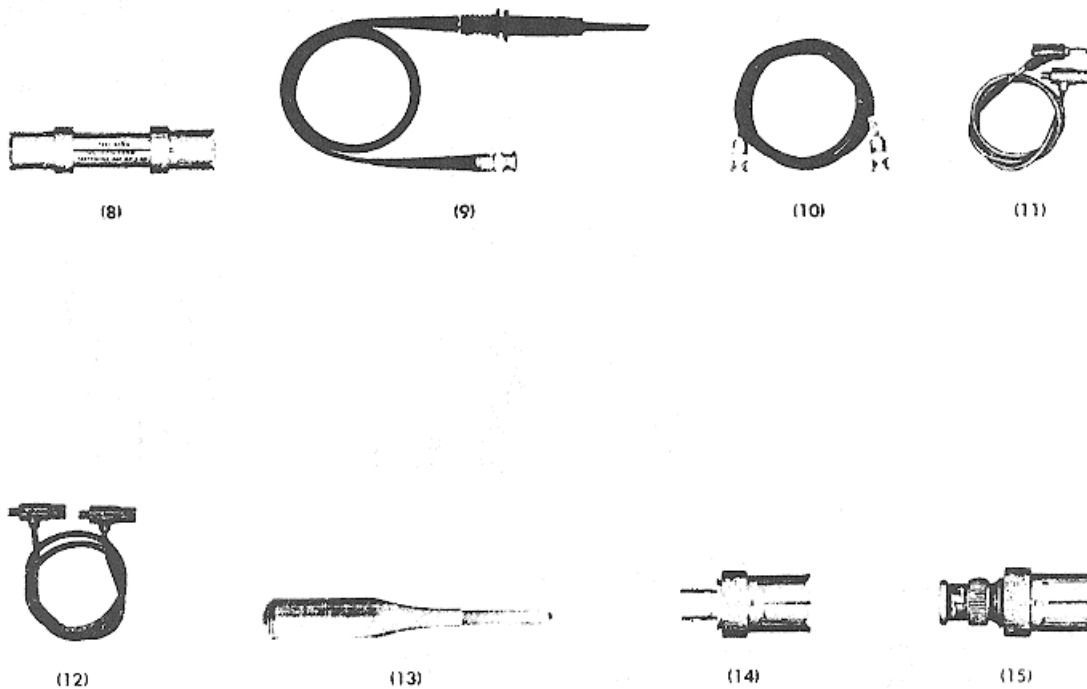

Fig. 6-2. Recommended calibration equipment, items 8 through 15.

- 1. Adjust -100-Volt Power Supply (Page 6-5) --100 volts, ± 3 volts.
- 2. Adjust +125-Volt Power Supply (Page 6-5) 4-125 volts, ± 3.8 volts.
- 3. Adjust --300-Volt Power Supply (Page 6-6) +300 volts, ± 9 volts.
- 4. Adjust -.1 2.2-Volt Power Supply (Page 6-6) --12.2 volts, ± 0.37 volt.
- 5. Adjust High-Voltage Power Supply (Page 6-6) -3300 volts, ± 100 volts.
- 6. Check Low-Voltage Power Supply Regulation (Page 6-6)

--100 volt	± 1 volt
+125 volt	± 1.25 volts
+300 volt	± 3 volts
--12.2 volt	± 0.12 volt

Check regulation at low and high line.
- 7. Check High-Voltage Power-Supply Regulation (Page 6-7)

--100 volt	5 millivolts
+125 volt	10 millivolts
+300 volt	80 millivolts
--12.2 volt	3 millivolts
-3300 volt	DO NOT MEASURE
- 8. Adjust Calibrator Amplitude (Page 6-8) +100 volts, ± 3 volts.
- 9. Check D838-D839 Junction Voltage (Page 6-8) Less than +0.6 volt DC.
- 10. Check Power-Supply Ripple (Page 6-9)
- 11. Adjust Astigmatism (Page 6-10) Sharp, well-defined display.
- 12. Adjust Trace Alignment (Page 6-10) Trace parallel to horizontal graticule lines
- 13. Adjust Cathode-Ray Tube Geometry (Page 6-11) Best overall geometry.

(A)(B)

- 14. Check Calibrator Accuracy (Page 6-12)
Within $\pm 3\%$ of indicated voltage.
- 15. Check Calibrator Risetime and Symmetry (Page 6-14)
Risetime, less than 6 microseconds; symmetry, 40% to 60%.
- 16. Adjust Vertical and Horizontal Deflection-Plate Compensation (Page 6-15)
Optimum square corner (or 14.3 picofarads effective capacitance).
- 17. Check Dual-Trace Chopped Blanking (Page 6-17)
Blanking of between channel switching transients (with dual-trace amplifier unit).
- 18. Check CRT Intensifier Circuit (Page 6-18)
Intensified portion on trace (with delayed sweep time-base unit).
- 19. Check CRT Vertical Sensitivity (Page 6-19) 19.5 volts, ± 1 volt.
- 20. Check CRT Horizontal Sensitivity (Page 6-19) 18.4 volts, ± 0.9 volt.
- 21. Check Intensity (Z-Axis) Modulation (Page 6-19)
Intensity modulation with 10 volts input.

CALIBRATION PROCEDURE**General**

The following procedure is arranged in a sequence which allows the Type RM561A to be calibrated with the least interaction of adjustments and reconnection of equipment. If desired, the steps may be performed individually or out of sequence. However, some adjustments affect the calibration of other circuits within the instrument. In this case, it will be necessary to check the operation of other parts of the instrument. When a step interacts with others, the steps which need to be checked will be noted.

Any needed maintenance should be performed before proceeding with calibration. Troubles which become apparent

during calibration should be corrected using the techniques given in the Maintenance section.

The Adjust . . . **Ⓢ** steps in the following procedure provide a check of instrument performance, whenever possible, before the adjustment is made. To prevent recalibration of other circuits when performing a partial calibration, readjust only if the listed tolerance is not met. However, when performing a complete recalibration, best overall performance will be provided if each adjustment is made to the exact setting, even if the CHECK . . . is within the allowable tolerance. The symbol **Ⓢ** is used to identify the steps in which an adjustment is made.

In the following calibration procedure, a test equipment setup is shown for each major group of adjustments and checks. Beneath each setup picture is a complete list of front-panel control settings for the Type RM561A. To aid in locating individual controls which have been changed during complete calibration, these control names are printed in bold type. If only a partial calibration is performed, start with the nearest setup preceding the desired portion.

The following procedure uses the equipment listed under Equipment Required. If substitute equipment is used, control settings or setup must be altered to meet the requirements of the equipment used.

Preliminary Procedure

1. If the Type RM561A is mounted in a cabinet rack, pull it out to the fully extended position.
 2. Remove the top and bottom covers from the Type RM561 A.
 3. Insert the amplifier plug-in unit in the left plug in compartment.
 4. Insert the time-base plug-in unit in the right plug-in compartment.
 5. Connect the autotransformer to a suitable power source.
 6. Connect the Type RMA561 A to the autotransformer output.
 7. Set the autotransformer to 15 (or 230) volts.
 8. Set the Type RM561A POWER switch to ON.
- Allow at least 20 minutes warm it) for checking the instrument the given accuracy.

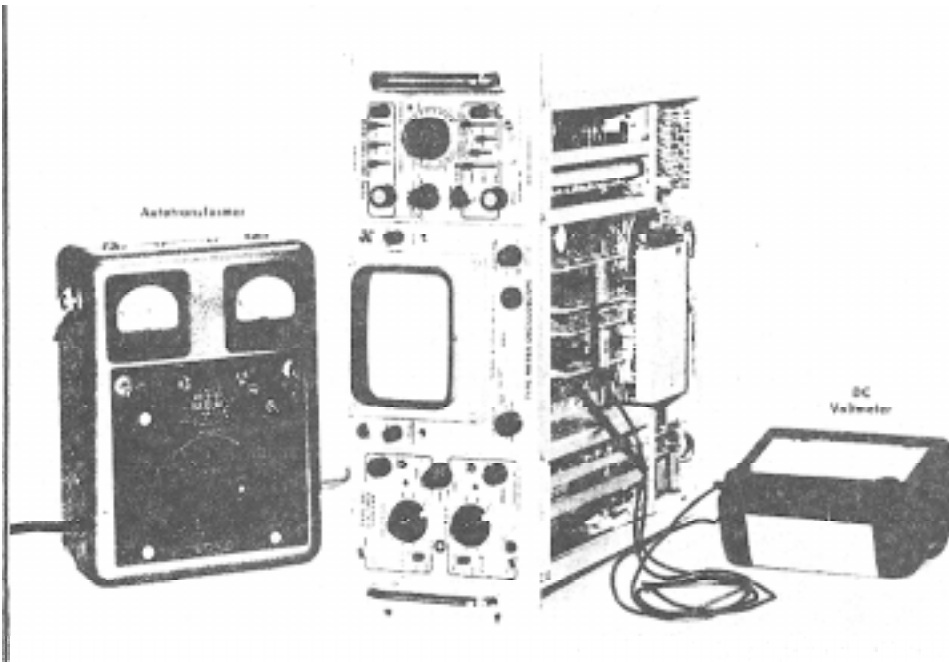

Fig. 6-3. Test equipment setup for power supply adjustments.

Control Settings

Variable
Triggering controls

Calibrated
Any Position

Type RM561A

1. Adjust --100-Volt Power Supply It

①

FOCUS Any position
INTENSITY Midrange
CALIBRATOR OFF
SCALE ILLUJM Clockwise
CRT CATHODE SEI ECTOR Normal

- a. Test equipment setup is shown in Fig 6-3.
- b. Connect the DC voltmeter from the - 100 volt test point (Fig. 6-4A) to chassis ground.
- c. CHECK -Meter reading; -- 100 volts, ± 3 volts.
- d. ADJUST - - 100V adjustment, R616 (Fig. 6-4B) for - 100 Volts.
- e. INTERACTION - May affect operation of all circuits within the Type RM561A.

Amplifier Unit

Position Midrange
AC DC Gnd AC
Volts/Division 1
Variable Calibrated

2. Adjust + 125-Volt Power Supply

①

Time-Base Unit

Position Midrange
Magnifier Off
Time/Division 1 millisecond

- a. Test equipment setup is shown in Fig. 6-3.
- b. Connect the DC voltmeter from the +125,-volt test point (Fig. 6-4A) to chassis, ground.
- c. CHECK-Meter reading; +125 volts, ± 3.8 volts.

(A)(B)

4. Adjust -1 2.2-Volt Power Supply ①

- a. Test equipment setup is shown in Fig. 6-3.
- b. Connect the DC voltmeter from the --12.2-volt test point (Fig. 6-6) to chassis ground.
- c. CHECK-Meter reading; -12.2 volts, ± 0.37 volt.
- d. ADJUST-12.2 Volts adjustment, R730 (Fig. 6-5), for -12.2 volts.
- e. INTERACTION-May affect operation of all circuits within the Type RM561A.

5. Adjust High-Voltage Power Supply ①

- a. Test equipment setup is shown in Fig. 6-3.
- b. Connect the DC voltmeter from the high-voltage test point (Fig. 6-7A) to chassis ground.
- c. CHECK-Meter reading; -3300 volts, ± 100 volts.
- d. ADJUST-High Voltage adjustment, R841 (Fig. 6-7B), for -3300 volts.
- e. INTERACTION-Check steps 7, 11-13 and 16.

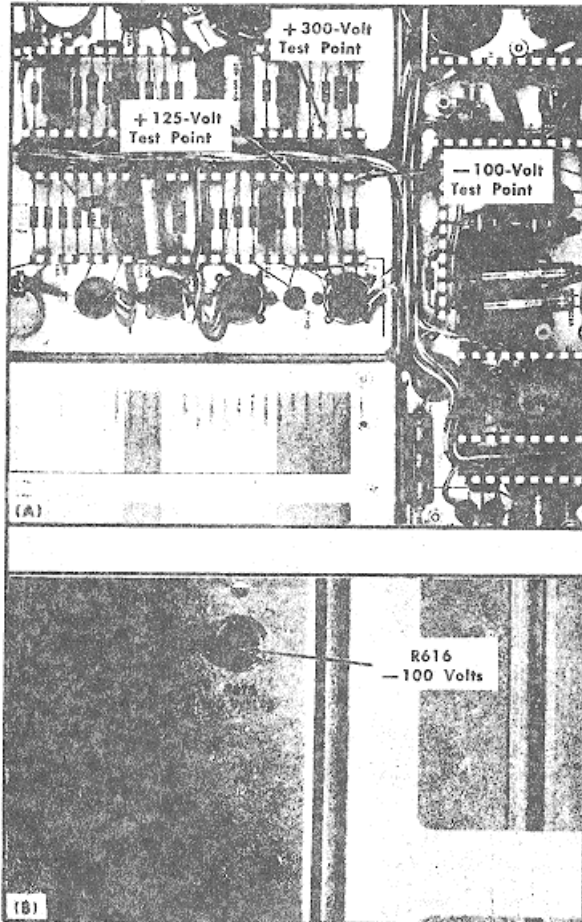

Fig. 6-4. (A) Location of -100-, +125- and +300-volt test points (bottom view), (B) location of -100-volt adjustment (top view).

- d. ADJUST-+125 Volts adjustment, R656 (Fig. 6-5), for +125 volts.
- e. INTERACTION-May affect operation of all circuits within the Type RM561A.

3. Adjust +300-Volt Power Supply ①

- a. Test equipment setup is shown in Fig. 6-3.
- b. Connect the DC voltmeter from the +300-volt test point (Fig. 6-4A) to chassis ground.
- c. CHECK-Meter reading; +300 volts, ± 9 volts.
- d. ADJUST-+300 Volts adjustment, R676 (Fig. 6-5), for +300 volts.
- e. INTERACTION-May affect operation of all circuits within the Type RM561A.

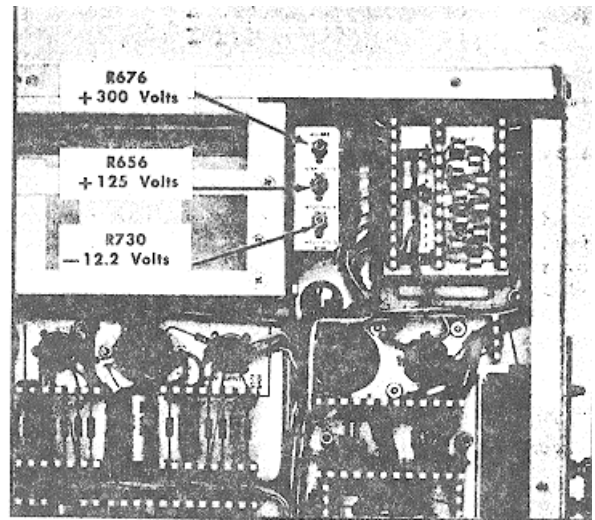

Fig. 6-5. Location of + 125-, +300- and --12.2-volt adjustment (bottom view).

6. Check Low-Voltage Power-Supply Regulation

- a. Test equipment setup is shown in Fig. 6-3.
- b. Connect the DC voltmeter from the --100-volt test point (Fig. 6-4A) to chassis ground.
- c. With the autotransformer set to 117 volts (or 234 volts) note the test point voltage

(A)(B)

- d. Set the autotransformer to 105 (210) volts and again check the voltage. Voltage should be within 1 volt of reading in step c.
- e. Set the autotransformer to 125 (250) volts and check the voltage. Voltage should be within 1 volt of reading in step c.
- f. Remove both plug-ins from the instrument (minimum load).
- g. With the autotransformer set to 125 (250) volts, the voltage should be within 1 volt of reading in step c.
- h. Return the autotransformer to 105 (210) volts and check the voltage. Voltage should be within 1 volt of reading in step c.

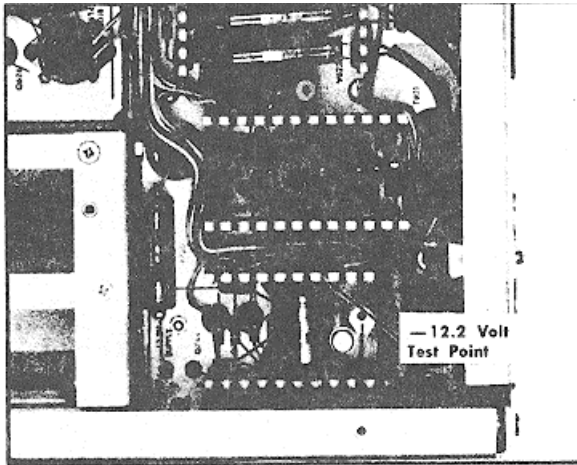

Fig. 6-6. Location of -12.2-volt test point (bottom view).

- i. Repeat this procedure for each low-voltage supply. Table 6-1 shows maximum voltage deviation allowable for each supply. Test point locations are shown in Figs. 6-4A and 6-6.

NOTE

A 150-milliamp minimum load current is necessary for proper regulation of the --12.2-volt supply. Minimum-load regulation of this supply can be checked by placing an 82-ohm, 5-watt resistor between pins 5 and 16 of either interconnecting plug.

TABLE 6-1.

Power Supply	Maximum Voltage Deviation
-100 volt	1 volt
+125 volt	1.25 volts
+300 volt	3 volts
-12.2 volt	0.12 volt

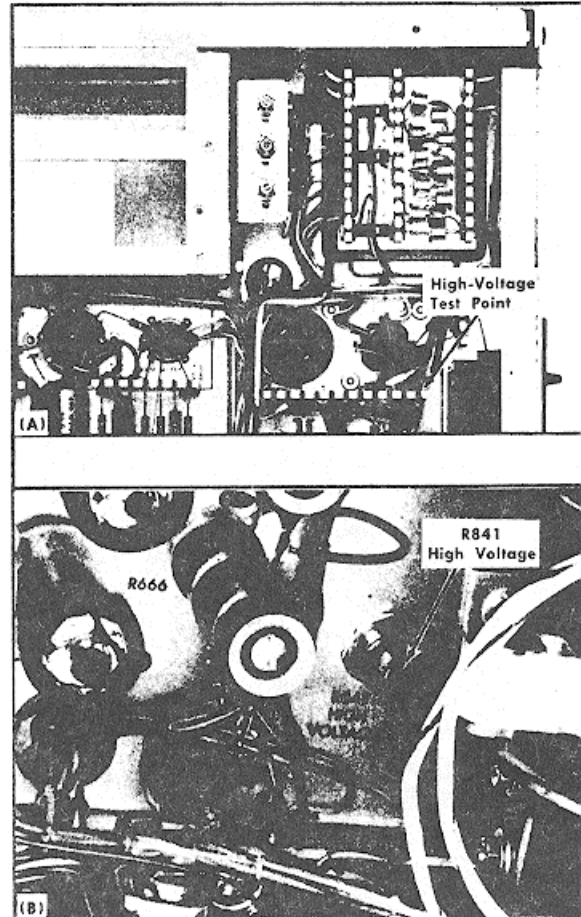

Fig. 6-7. (A) Location of high-voltage test point (bottom view), location of high-voltage adjustment (top view).

7. Check High-Voltage Power-Supply Regulation

- a. Test equipment setup is shown in Fig. 6-3.
- b. Connect the DC voltmeter from the high-voltage test point (Fig. 6-7A) to chassis ground.
- c. Set the autotransformer to 117 (234) volts and note the voltage at the test point.
- d. Set the autotransformer to 105 (210) volts and check the voltage. It should be within 100 volts of reading in step c.

(A)(B)

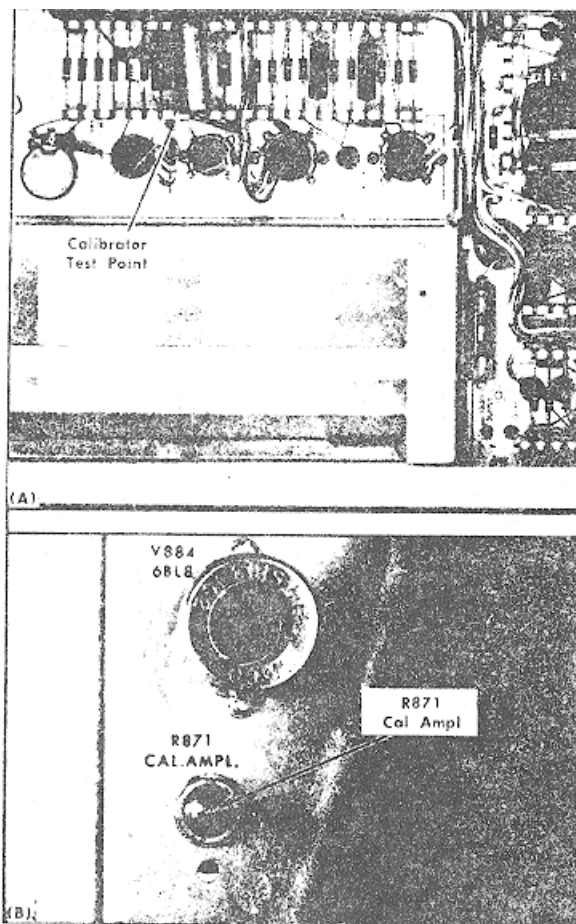

Fig. 6-8. (A) Location of calibrator test point bottom view), (B) location of calibrator adjustment (top view)

e. Set the autotransformer to 125 (250) volts and check the voltage. Voltage should be within 100 volts of reading in step c.

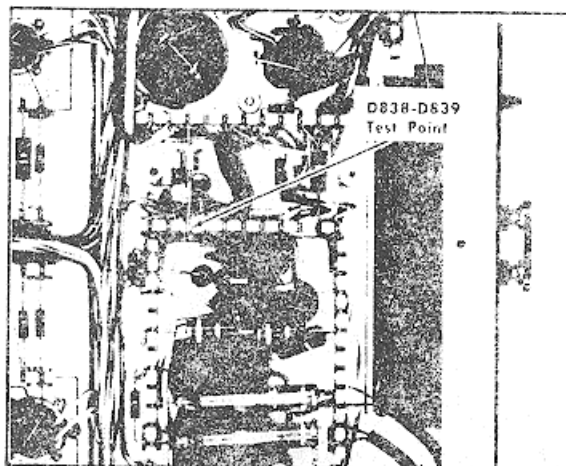

Fig 6-9. Location of D838-D839 test point (bottom view).

f Return the autotransformer to 117 (234) volts and disconnect the voltmeter.

8. Adjust Calibrator Amplitude

- a. Test equipment setup is shown in Fig. 6-3.
- b. Connect the DC voltmeter from the calibrator test point (Fig. 6-8A) to chassis ground
- c. CHECK---Meter reading; 4-100 volts, ± 3 volts Be sure the CALIBRATOR switch is set to OFF.
- d. ADJUST--Cal Ampl adjustment, R871 (Fig 6-8B), for + 100 volts.

9. Check D838-D839 Junction Voltage

- a. Connect the voltmeter from the D838-D839 test point (Fig 6-9) to chassis ground.
- b. CHECK--Voltage should be less than +0.6 volt DC. Higher voltages could damage a time-base unit with an intensifying circuit.

(A)(B)

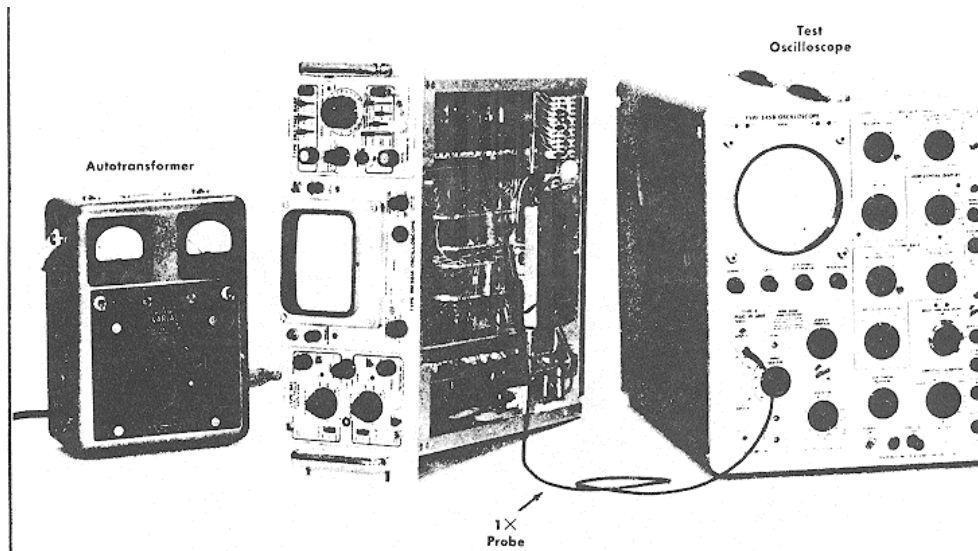

Fig. 6-10. Test equipment setup for power-supply ripple measurements.

Control Settings

Type RM561A

FOCUS Any position
 INTENSITY Midrange
 CALIBRATOR OFF
 SCALE ILLUM Clockwise
 CRT CATHODE SELECTOR Normal

Amplifier Unit

Position Midrange
 AC DC Gnd AC
 Volts/Division 1
 Variable Calibrated

Time-Base Unit

Position Midrange
 Magnifier Off
 Time/Division 1 millisecond
 Variable Calibrated
Triggering controls Adjust so sweep is not triggered

b. Connect the 1X probe to the test oscilloscope input.

c. Set the test oscilloscope volts/division switch to 0.005. Set the input coupling switch to AC.

d. Measure the line-frequency ripple of each regulated power supply at the power-supply test points. Test points are shown in Figs. 6-4A and 6-6. Table 6-2 gives maximum ripple for each supply. Check ripple with autotransformer set at 105 and 125 (210 and 250 if wired for 234-volts nominal). Fig. 6-11 shows typical test oscilloscope display.

e. Disconnect the test oscilloscope and return the auto-transformer to line voltage (instrument may be connected directly to line).

TABLE 6-2

Power Supply	Maximum Ripple (millivolts)
-100 volt I	5
+125 volt	10
+300 volt -	80
--12.2 volt	3
-3300 volt	DO NOT MEASURE

10. Check Power-Supply Ripple

a. Test equipment setup is shown in Fig. 6-10.

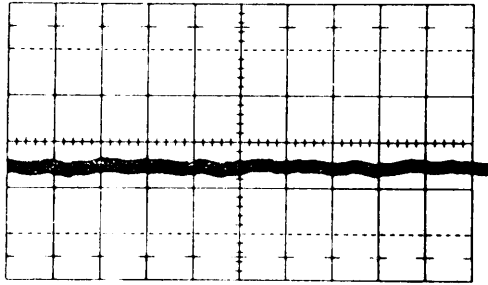

Fig. 6-1 1. Typical test oscilloscope display showing power-supply ripple (-100-volt supply). Volts/division, 0.005 volts, AC coupled; time/division, 5 milliseconds.

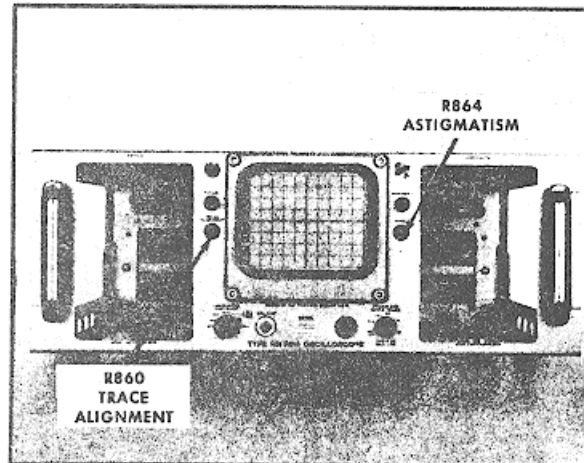

Fig. 6-12. Location of ASTIGMATISM and TRACE ALIGNMENT controls(front panel).

11. Adjust Astigmatism



- a. Set the time-base unit triggering controls to produce a trace on the CRT.
- b. ADJUST--FOCUS control and ASTIGMATISM adjustment, R864 (Fig. 6-12) for a sharp, well-defined display over the entire trace length.
- c. Slight readjustment of these controls may be necessary during normal operation.

12. Adjust Trace Alignment



- a. Adjust the amplifier unit Position control to move the trace to the horizontal graticule centerline.
- b. CHECK-The trace should be parallel with the centerline.
- c. ADJUST-TRACE ALIGNMENT adjustment, R860 (Fig. 6-12), so the trace is parallel with the horizontal graticule lines.

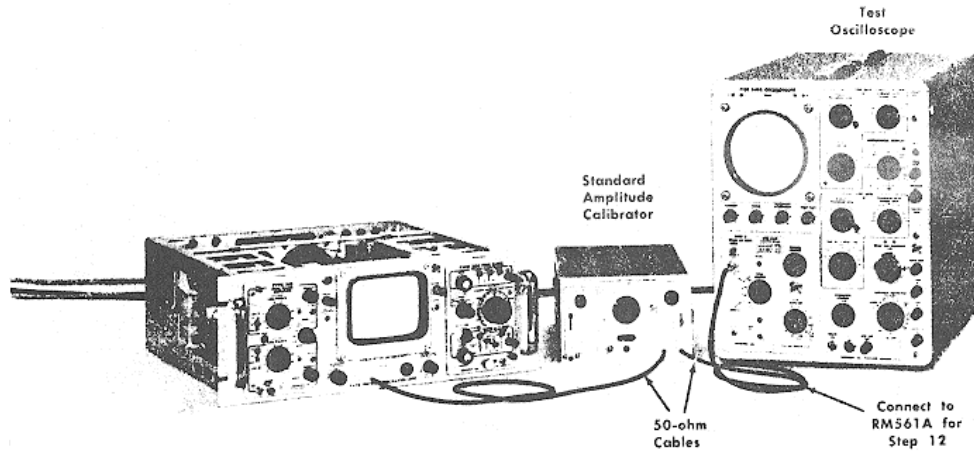

Fig. 6-13. Test equipment setup for geometry adjustment and CALIBRATOR check.

Control Settings

Type RM561A

FOCUS	Adjust for focused display
INTENSITY	Midrange
CALIBRATOR	100 V
SCALE ILLUM	Clockwise
CRT CATHODE SELECTOR	Normal

Amplifier Unit

Position	Midrange
AC DC Gnd	AC
Volts/Division	1
Variable	Calibrated

Time-Base Unit

Position	Midrange
Magnifier	Off
Time/Division	1 millisecond
Variable	Calibrated

Triggering Controls **Automatic**

13. Adjust Cathode-Ray Tube Geometry **①**

- a. Test equipment setup is shown in Fig. 6-13.
- b. Set the Standard Amplitude Calibrator controls as follows (if the test oscilloscope has a 1-kHz Calibrator, it may be used for this step):

Amplitude	10 Volts
Mode	Square wave
Function	Up
Power	On

- c. Connect the Standard Amplitude Calibrator Output connector to the amplifier unit input connector.

- d. Adjust the time-base unit Position and Variable Time/Division controls so a rising portion of the waveform coincides with the left and right graticule lines. The INTENSITY control may need to be advanced slightly to view the rising portions of the waveform (top and bottom of square wave should be positioned off of the viewing area).

- e. CHECK-Good linearity at the left and right edges of the graticule (Fig. 6-14A shows typical CRT display as well as examples of poor geometry).

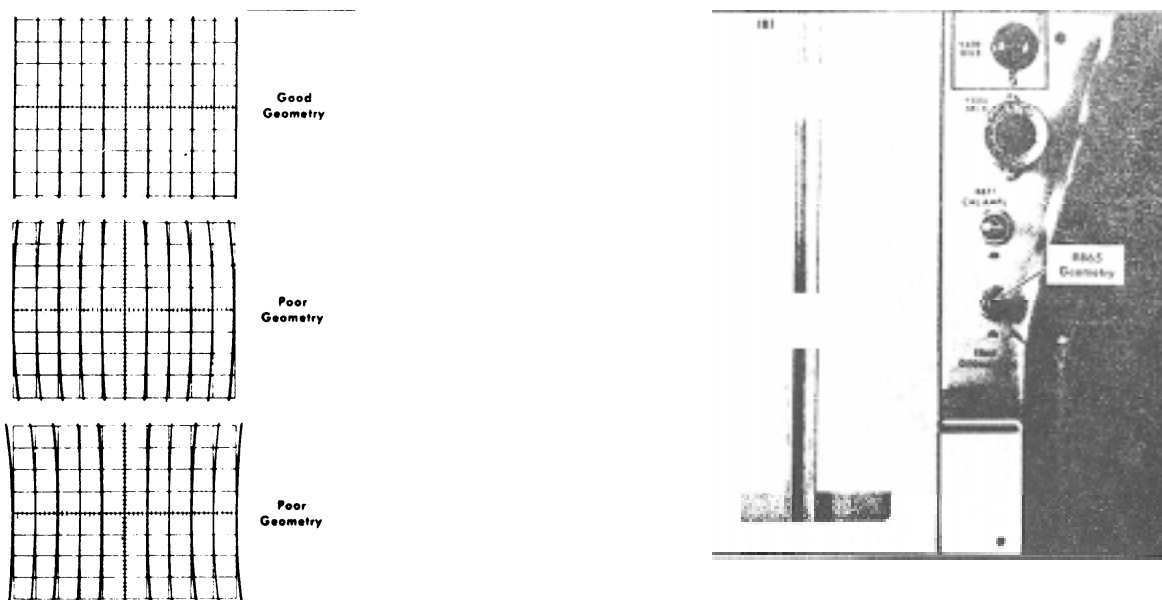

Fig. 6-14. (A) Idealized waveforms showing good geometry with examples of poor geometry, (B) location of Geometry adjustment (top view).

f. ADJUST-Geometry adjustment, R865 (Fig. 6-14B), for best linearity at left and right edges of the graticule. If a setting cannot be found that provides best linearity on both sides of the graticule, a compromise setting will be necessary to provide best overall linearity.

g. Disconnect the signal from the amplifier unit input and return the INTENSITY control to normal setting.

14. Check Calibrator Accuracy

a. Test equipment setup is shown in Fig. 6-13.

b. Change the following Standard Amplitude Calibrator controls:

Amplitude	100 Volts
Mode	+DC
Function	Mixed
AC DC Gnd	DC

c. Connect the CAL OUT connector to the Standard Amplitude Calibrator Unknown Input with a 50-ohm cable.

d. Connect the standard Amplitude Calibrator Output connector to the test oscilloscope input (minimum deflection factor, 0.005 volts/division) with a 50-ohm cable.

e. Connect the six-inch jumper lead from pin 8, V884 (Fig. 6-15A), to chassis ground. This provides a DC calibrator output voltage.

f. The difference between the Standard Amplitude Calibrator +DC voltage and the Type RM561A CALIBRATOR output voltage should be less than 3%. Table 6-3 gives maximum allowable difference for 3% CALIBRATOR accuracy at each position of the CALIBRATOR switch. (The Standard Amplitude Calibrator output can be identified by setting the Type RM561A CALIBRATOR switch to a higher or lower position; the signal which remains is the Standard Amplitude Calibrator output.) Fig. 6-15B shows a typical test oscilloscope display. Check accuracy of all positions between 100V and 100 mV.

g. Set the CALIBRATOR switch to the 1 V INTO 50Ω position (1 V position).

h. Connect the 50-ohm termination (067-0515-00) between the CAL OUT connector and the 50 ohm table using the GR to BNC adapters.

i. Leave the Standard Amplitude Calibrator Amplitude switch set to .1 Volts and set the test oscilloscope volts/division switch to 0.005.

j. The test oscilloscope display should be 0.6 division or less in amplitude for 3% accuracy.

k. Remove the 50-ohm termination and -connect the 50-ohm cable to the CAL OUT connector.

l. Connect the Standard Amplitude Calibrator Output connector to the X 100 Amplifier Input connector with a 50-ohm cable.

(A)(B)

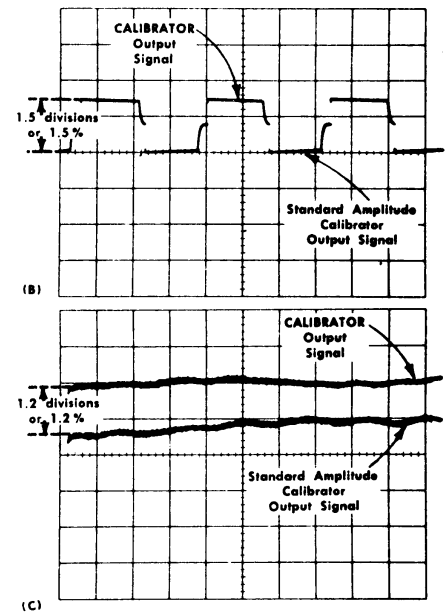
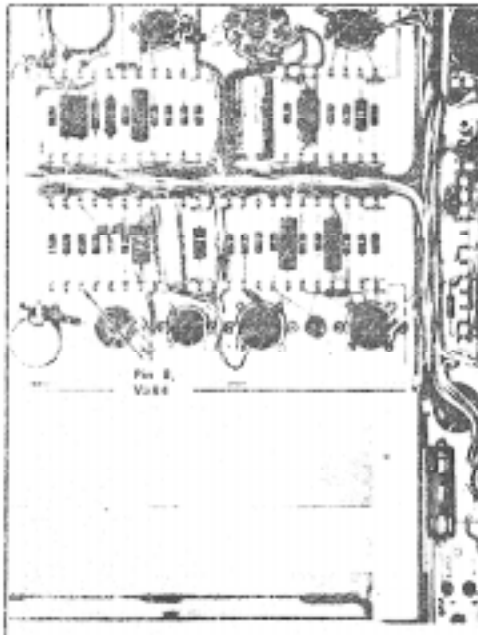

Fig. 6-15 (A) Location of Pin 8, V884 (bottom view), (B) typical test-oscilloscope display showing about +1.5% error in the 10V position (volts/division, 0.1 volts; time/division, 5 milliseconds), (C) typical test-oscilloscope display showing about +1.2% error in the 10mV position (volts/division, 20 millivolts; time/division, 0.2 milliseconds; using X100 Amplifier section).

m. Connect the Output ± 50 V Max connector to the input of the test oscilloscope.

n. Set the test oscilloscope time/division switch to 0.2 milliseconds. Adjust the Standard Amplitude Calibrator Output DC. Level control to center the trace on the screen.

o. Check the accuracy of the 10mV and 1 mV CALIBRATOR switch positions. Table 6-3 gives maximum allowable difference and control settings. Fig. 6-15C shows a typical test oscilloscope display.

p. Disconnect all test equipment and remove the jumper lead from pin 8 of V884.

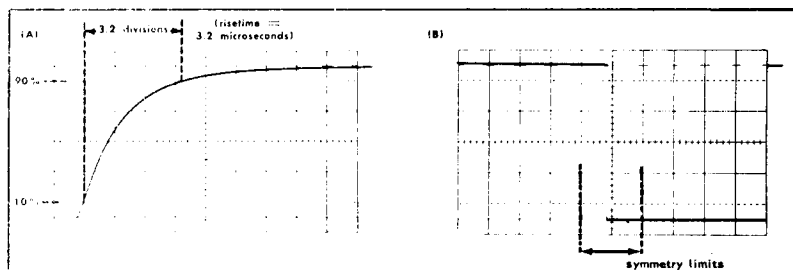

Fig 6-16. (A) Typical test oscilloscope display for checking Calibrator risetime (time/division, 1 microsecond), (B) typical test oscilloscope display for checking Calibrator symmetry.

TABLE 6-3

Type RM561 A CALIBRATOR setting and Standard Amplitude	Test Oscilloscope Volts/Division Switch Setting	Maximum Display Amplitude for 3% Accuracy (divisions)
100 V	1 Volt	3 ⁵
10 V	.1 Volt	3
1 V	10 Millivolts	3
100 mV	5 Millivolts	0.6
10 mV	10 Millivolts	3
1 mV	5 Millivolts	0.6

⁵For maximum Calibrator accuracy, reset the Cal Ampl adjustment for minimum difference

15. Check Calibrator Risetime and Symmetry

a. Test equipment setup is shown in Fig. 6-13.

- b. Connect the CAL OUT connector to the vertical input of the test oscilloscope with a 50-ohm cable.
- c. Set the CALIBRATOR switch to 1 V.
- d Set the test oscilloscope time/division switch to 1 microsecond and the volts/division and variable control for exactly 5 divisions of display (four divisions if using 540A-series test oscilloscope).
- e. Check for risetime of less than 6 microseconds as shown by less than 5 divisions between the 10% and 90% points on the test oscilloscope display (see Fig. 6-16A).
- f. Set the test oscilloscope Time/Division switch and Variable control to display one complete cycle of the calibrator signal in 10 divisions. Adjust the triggering controls, If necessary, so the display starts on the leading edge of the waveform.
- g. Check for Calibrator symmetry of $\pm 20\%$. This is shown by each segment of the square wave having a length of 4 to 6 divisions (see Fig. 6-16B).
- h. Disconnect the test oscilloscope.

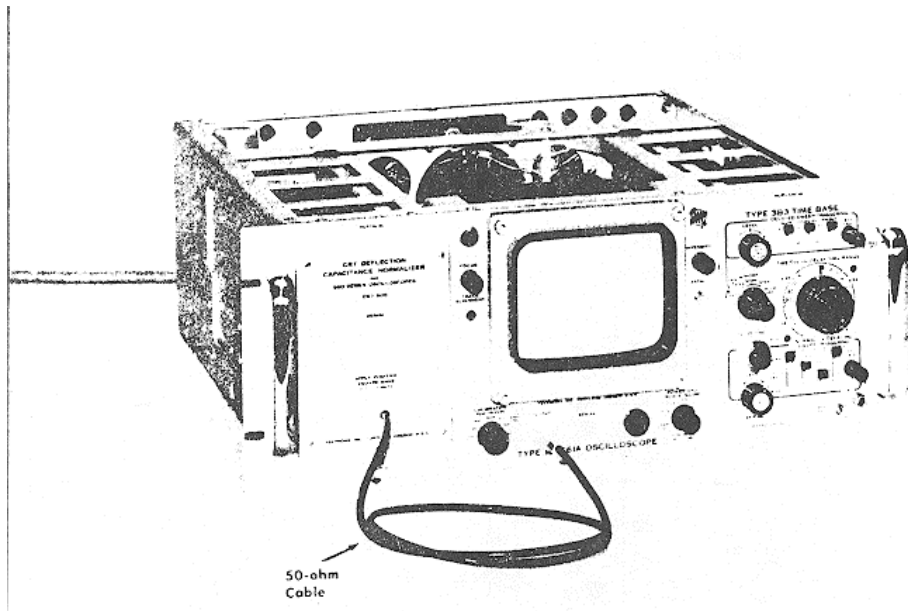

Fig. 6-17. Test equipment setup for vertical and horizontal compensation.

(A)(B)

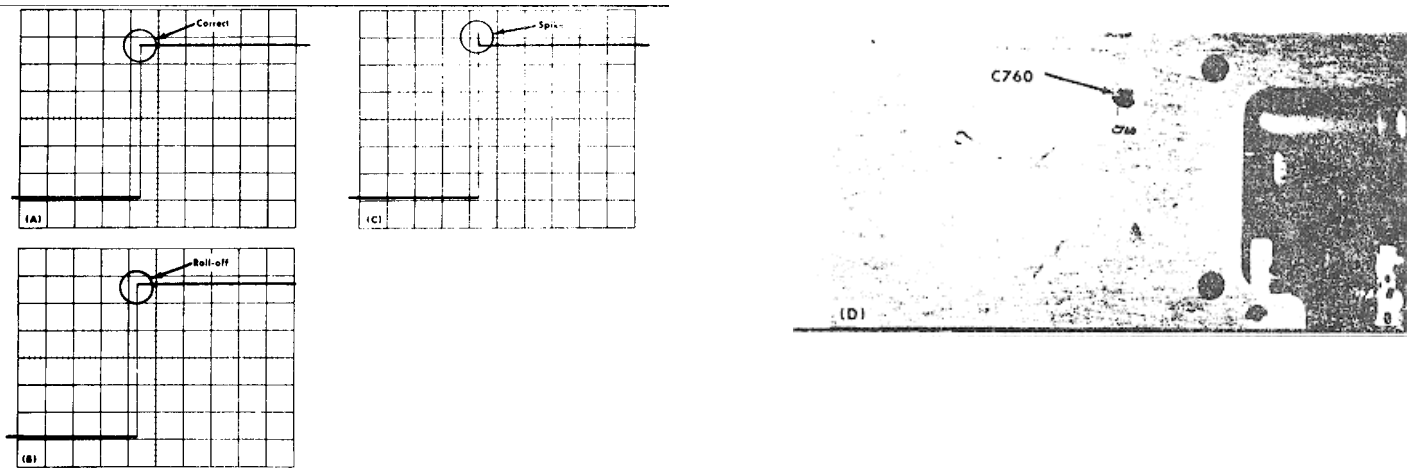

Fig. 6-18. (A) Typical CRT display showing correct vertical compensation adjustment, (B) and (C) incorrect adjustment, (D) location of C760 (left side).

Control Settings

Type RM561A

FOCUS	Adjust for focused display
INTENSITY	Midrange
CALIBRATOR	100 V
SCALE ILLUM	Clockwise
CRT CATHODE SELECTOR	Normal

Amplifier unit

Position	Midrange
AC DC Gnd	AC
Volts/Division	1
Variable	Calibrated

Time-Base Unit

Position	Midrange
Magnifier	Off
Time/Division	.2 millisecond
Variable	Calibrated
Triggering Controls	Adjust for triggered sweep

16A. Adjust Vertical and Horizontal Deflection-0 Plate Compensation

- a. Test equipment is shown in Fig. 6-17.
- b. Insert the CRT Deflection Capacitance Normalizer into the left plug-in compartment
- c. Connect the CAL OUT connector to the Capacitance Normalizer input connector.
- d. Adjust the time-base triggering controls so the leading edge of the waveform is displayed.

NOTE

The INTENSITY control may need to be advanced slightly to view the leading edge of the waveform

- e. CHECK-For optimum square corner (see: Fig. 6-18A).
- f. ADJUST--C760 (Fig. 6-18D) for optimum square corner.
- g. Interchange the Capacitance Normalizer and the time-base unit. Readjust the FOCUS control and the time-base triggering controls for a stable well-focused display.
- h. CHECK--For optimum square corner (see Fig. 6-19A).

(A)(B)

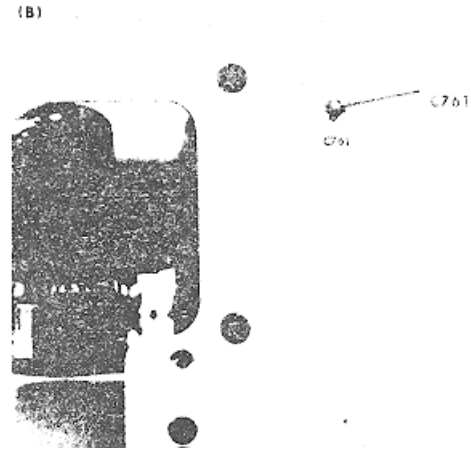
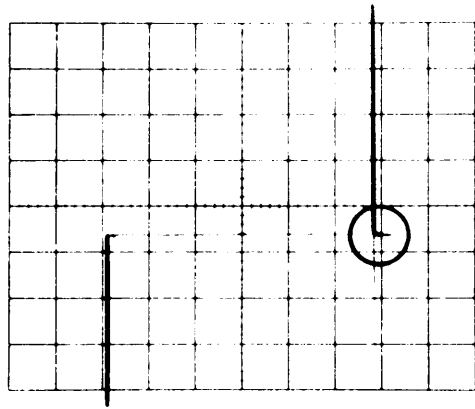

Fig. 6-19. (A) Typical CRT display showing correct adjustment of horizontal compensation, (B) location of C761 (right side)

- i. ADJUST-C761 (Fig. 6-19B) for optimum square corner.
- j. Remove the Capacitance Normalizer. Replace the amplifier unit in the left compartment and the time-base unit in the right compartment.

16B. Alternative Method of Adjusting Deflection Plate Compensation

NOTE

The following method can be used to adjust the deflection-plate compensation if a Capacitance Normalizer is not available.

The effective deflection-plate capacitance of the CRT is the capacitance seen by the plug-in unit when the deflection plates are driven push-pull. Therefore, it cannot be measured directly with a capacitance meter. However, the Individual circuit capacitances which make up the effective deflection-plate capacitance can be measured. These individual circuit capacitances are shown schematically in Fig. 6-20. C1 and C.2 represent the capacitance from each deflection plate to ground. C3 represents the capacitance between the deflection plates. The variable capacitor is made up of the circuit capacitance plus the capacitor added for adjustment.

The variable capacitor for the vertical (left) plug-in compartment may be C3 (Fig. 6-20A) or C2 (Fig. 6-20B) depending on other circuit capacitance values.

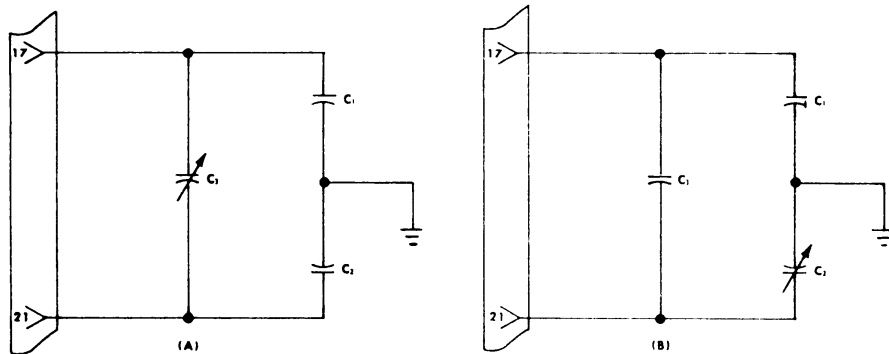

Fig. 6-20. Schematic representation of the effective CRT deflection-plate capacitance; (A) configuration 1, (B) configuration 2.

(A)(B)

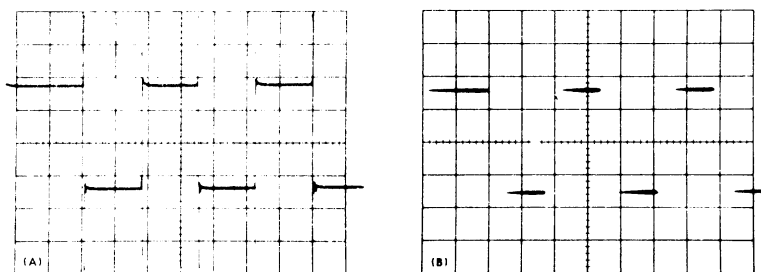

Fig. 6-21. Typical CRT display showing correct chopped blanking. (A) Chopped transients visible with CRT CATHODE SELECTOR switch up (time/division, 2 microseconds), (B) transients blanked out with CRT CATHODE SELECTOR switch in the CHOPPED BLANKING position.

Check the instrument to determine the configuration and formula to use for correct deflection-plate capacitance.

The effective deflection-plate capacitance, C_{eff} can be expressed in terms of C1, C2, and C3 as follows:

$$C_{eff} = \frac{C1 + C2}{2} + C3$$

Setting C_{eff} , equal to 14.3 picofarads (value set at factory), the value of the variable capacitor can be calculated.

Configuration 1, Fig. 6-20A. $C3 = 7.15 \text{ pF} - \frac{C1 + C2}{4}$

Configuration 2, Fig. 6-20B. $C2 = 28.6 \text{ pF} - 4(C3) - C1$

a. Disconnect the power cord and isolate the Type RM561A from ground.

b. Remove both plug-in units.

c. Connect the capacitance meter guard voltage to pin 21 of the vertical plug-in compartment and measure the capacitance between pin 17 and the oscilloscope chassis this is C1.

d. Connect the capacitance meter guard voltage to pin 17 and measure the capacitance between pin 21 and the oscilloscope chassis-- this is C2. (For configuration 2, connect the guard voltage to the oscilloscope chassis and measure the capacitance between pin 17 and 21--this is C3.)

e. Substitute the measured capacitance values into the equation and solve for C3 configuration 2, solve for C2).

f. Connect the guard voltage to the oscilloscope chassis and measure the capacitance between pins 17 and 21. (For configuration 2, connect the guard voltage to pin 17 and measure the capacitance between pin 21 and the oscilloscope chassis.)

g. Adjust C760 until the measured capacitance equals the value calculated for C3 in step e (configuration 2, adjust C760 for calculated value of C2).

h. Repeat steps c through g for the horizontal (right) plug-in compartment. Fig. 6-20A shows the individual capacitances for the horizontal plug-in compartment.

17. Check Dual-Trace Chopped Blanking

a. Set the amplifier unit Mode switch to Chopped (this check can be made only with a dual-trace plug-in unit).

b. Set the amplifier unit AC DC Gnd switches to Gnd.

c. Position the traces about three divisions apart.

d. Set the time-base Time/Division switch to display several cycles of the waveform and adjust the triggering controls for a stable display.

e. With the CRT CATHODE SELECTOR switch in the normal position, notice the overshoot on the display (see Fig 6-21A).

f. Set the CRT CATHODE SELECTOR switch to CHOPPED BLANKING. The between-channel switching transients should be removed from the display (see Fig. 6-21B).

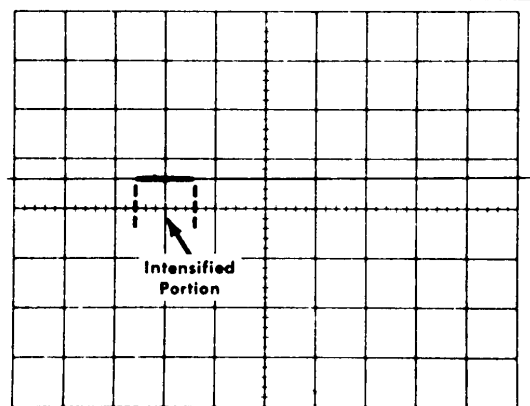

Fig. 6-22. Typical CRT display showing correct intensifier circuit operation.

18. Check CRT Intensifier Circuit

- a. Set the time-base Time/Division switch to 1 millisecond and the delayed sweep Time/Division switch to 0.1 millisecond (this check can be made only with a delayed sweep plug-in unit).
- b. Set the amplifier unlit mode switch to display only one channel.
- c. Adjust the time-base triggering controls to produce a trace.

- d. Adjust the FOCUS control and the time-base triggering controls for a well-focused free-running (or automatic triggered) trace.
- e. Turn the time-base Mode switch to Intensified (not triggered).
- f. An intensified portion should appear on the trace (see Fig. 6-22). If the display appears only as a shortened trace, increase the INTENSITY setting slightly until the complete trace, showing on intensified portion, appears.
- g. Turn the delay time control throughout its range and check that the intensified portion moves along the trace.

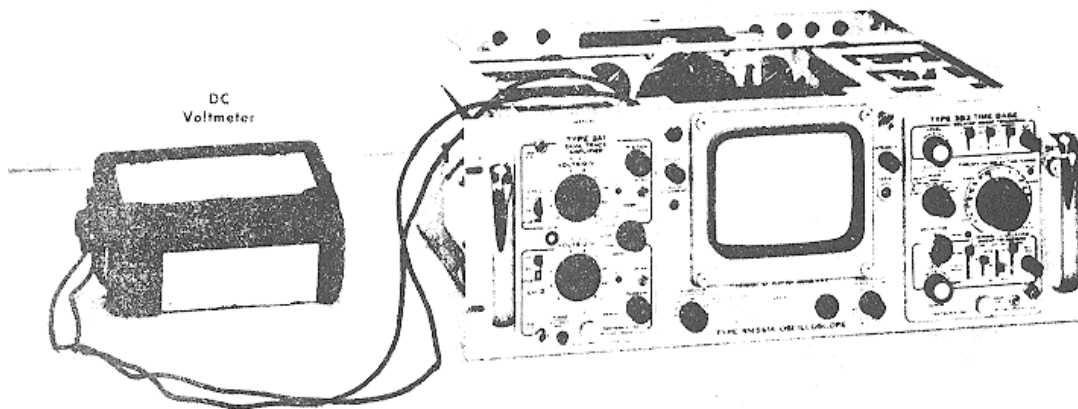

Fig. 6-23. Test equipment setup for checking CRT vertical and horizontal sensitivity.

<p>Control Settings Type RM561 A FOCUS</p>	<p>Adjust for focused display</p>	<p>AC DC Gnd Volts/Division Variable</p>	<p>AC 1 Calibrated</p>
<p>INTENSITY CALIBRATOR Position SCALE ILLUM CRT CATHODE SELECTOR</p>	<p>Midrange 10 V Midrange Clockwise Normal</p>	<p>Time-Base Unit</p>	<p></p>
<p>Amplifier Unit Position</p>	<p>Midrange</p>	<p>Magnifier Time/Division Variable Triggering controls</p>	<p>Off 10 milliseconds Calibrated Automatic</p>

(A)(B)

CAUTION

In steps 19 and 20 be careful not to short the CRT deflection pins to chassis ground.

19. Check CRT Vertical Sensitivity

- a. Test equipment setup is shown in Fig. 6-23.
- b. Connect the DC voltmeter between the vertical deflection-plate pins. Be careful not to bend the pins.
- c. Turn the amplifier unit Position control to move the trace to the top graticule line.
- d. Note the meter reading.
- e. Turn the amplifier unit Position control to move the trace to the bottom graticule line.
- f. Again note the meter reading.
- g. Calculate the difference in voltage between step d and f. Divide by 8 to determine the deflection voltage/ division (sensitivity).
- h. Sensitivity should be 19.5 volts/division, ± 1 volt.

20. Check CRT Horizontal Sensitivity

- a. Test equipment setup is shown in Fig. 6-23.
- b. Interchange the plug-ins so the time-base unit is in the left compartment and the amplifier unit is in the right compartment.
- c. Connect the DC voltmeter between the vertical deflection-plate pins. Be careful not to bend the pins.
- d. Adjust the FOCUS control and the time-base triggering controls for a well-focused free-running (or automatic triggered trace).
- e. Turn the amplifier unit Position control to move the trace to the left graticule line.
- f. Note the meter reading.
- g. Turn the amplifier unit Position control to move the trace to the right graticule line.
- h. Again note the meter reading.
- i. Calculate the difference in voltage between step f and h. Divide by 10 to determine the deflection voltage/ division (sensitivity).

(A)(B)

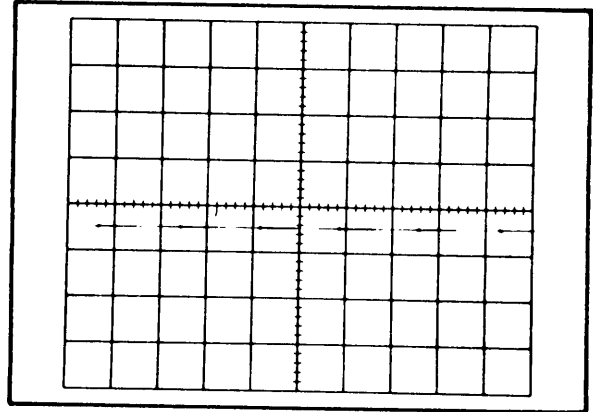

Fig. 6-24. Typical CRT display showing correct Intensity modulation (time/division, 10 milliseconds).

- j. Sensitivity should be 18.4 volts/division, ± 0.9 volt.
- k. Disconnect the voltmeter and return the amplifier unit to the left compartment and the time-base unit to the right compartment.

21. Check Intensity (Z-Axis) Modulation

- a. Remove the ground strap between the rear-panel binding posts.
- b. Connect the CALIBRATOR signal to the EXT CRT CATHODE binding post with the BNC-to-BNC and BNC-to-banana jack jumper leads.
- c. Check the display for intensified dots (see Fig. 6-24). It may be necessary to reduce the INTENSITY setting slightly to see the dots.
- d. Remove the jumper leads and replace the ground strap.

This completes the calibration of the Type RM561A. Disconnect all test equipment. Replace the top and bottom panels. The gain of the amplifier unit and timing of the time-base unit should be checked before using the system.

PARTS LIST ABBREVIATIONS



BHB	binding head brass	int	internal
BHS	binding head steel	lg	length or long
cap.	capacitor	met.	metal
cer	ceramic	mtg hdw	mounting hardware
comp	composition	OD	outside diameter
conn	connector	OHB	oval head brass
CRT	cathode-ray tube	OHS	oval head steel
csk	countersunk	PHB	pan head brass
DE	double end	PHS	pan head steel
dia	diameter	plstc	plastic
div	division	PMC	paper, metal cased
elect.	electrolytic	poly	polystyrene
EMC	electrolytic, metal cased	prec	precision
EMT	electrolytic, metal tubular	PT	paper, tubular
ext	external	PTM	paper or plastic, tubular, molded
F & I	focus and intensity	RHB	round head brass
FHB	flat head brass	RHS	round head steel
FHS	flat head steel	SE	single end
Fil HB	fillister head brass	SN or S/N	serial number
Fil HS	fillister head steel	SW	switch
h	height or high	TC	temperature compensated
hex.	hexagonal	THB	truss head brass
HHB	hex head brass	thk	thick
HHS	hex head steel	THS	truss head steel
HSB	hex socket brass	tub.	tubular
HSS	hex socket steel	var	variable
ID	inside diameter	w	wide or width
incd	incandescent	WW	wire-wound

PARTS PROVISIONING INFORMATION

REPLACEMENT PARTS

To obtain replacement parts, find the manufacturer's part number and description in this manual and then refer to the appropriate Repair Parts and Special Tools List (RPSTL) TH. In the RPSTL, find the assembly or subassembly first and then the description which corresponds with that in this manual. Under the description in the RPSTL find the manufacturer's part number, and then order the part by the listed Federal stock number. If the part is not listed in the RPSTL, it should be requisitioned from the NICP in accordance with AR 725-50.

SPECIAL NOTES AND SYMBOLS

X000	Part first added at this serial number
00 X	Part removed after this serial number
*000-0000-00	Asterisk preceding Tektronix Part Number indicates manufactured by or for Tektronix, Inc., or reworked or checked components.
Use 000-0000-00	Part number indicated is direct replacement.
	Screwdriver adjustment.
	Control, adjustment or connector.

**SECTION 7
ELECTRICAL PARTS LIST**

TYPE RM561A

Values are fixed unless marked Variable.

Ckt. No.	Tektronix Part No.	Description	S/N Range
		Bulbs	
B601	150-001	Incandescent, G.E. #47, Graticule Light	
B602	150-001	Incandescent, G.E. #47, Graticule Light	
B603	150-004	Incandescent, G.E. #328, Pilot Light	
B856	150-025	Neon, NE-2E	5001-12899
B856	150-0030-00	Neon, NE-2V	12900-up
B857	150-025	Neon, NE-2E	5001-12899
B857	150-0030-00	Neon, NE-2V	12900-up

Capacitors

Tolerance $\pm 20\%$ unless otherwise indicated.

Tolerance of all electrolytic capacitors are as follows (with exceptions):

3V - 50V	=	-10%, +250%
51 V - 350V	=	-10%, +100%
351 V - 450V	=	-10%, +50%

C611	285-510	.01 μ f	MT	400 v
C616	285-510	.01 μ f	MT	400 v
C640A,B	Use 290-224	340 μ f x 10 μ f	EMC	250 v
C644	Use 290-224	340 μ f x 10 μ f	EMC	250 v
C642A,B	Use 290-224	340 μ f x 10 μ f	EMC	250 v
C650	285-510	.01 μ f	MT	400 v
C667	290-002	8 μ f	EMT	450 v
C670	285-510	.01 μ f	MT	400 v
C720A	Use 290-086	2000 μ f	EMC	30 v
C720B	Use 290-086	2000 μ f	EMC	30 v
C732	Use 290-201	100 μ f	EMT	15v
C737	283-026	.2 μ f	Disc Type	25 v
C757	Use 290-231	100 μ f	EMT	25 v
C760	281-027	.7-3 μ f	Tub	Var.
C761	281-027	.7-3 μ f	Tub	Var.
C801	283-006	.02 μ f	Disc Type	600 v
C803	283-000	.001 μ f	Disc Type	500 v
C807	285-502	.001 μ f	MT	1000 v
C822	283-071	.0068 μ f	Disc Type	5000 v
C830	Use 283-0071-00	.0068 μ f	Disc Type	5000 v
C832	Use 283-0071-00	.0068 μ f	Disc Type	5000 v
C837	Use 283-0034-00	.005 μ f	Disc Type	4000 v
C841	285-519	.047 μ f	MT	400 v
C842	283-071	.0068 μ f	Disc Type	5000 v
C853	Use 283-0034-00	.005 μ f	Disc Type	4000 v
C876	290-025	6.25 μ f	EMT	300 v
C878	281-523	100 μ f	Cer	350 v
C884	281-524	150 μ f	Cer	500 v

(F)

Diodes

Ckt. No.	Tektronix Part No.	Description		S/N Range
D640A,B,C,D	*152-047	Silicon Replaceable by	1N2862	5001-10309
D640A,B,C,D	152-0066-00	Silicon	1N3194	10310-up
D642A,B,C,D	*152-047	Silicon Replaceable by	1N2862	5001-10309
D642A,B,C,D	152-0066-00	Silicon	1N3194	10310-up
D644A,B,C,D	*152-047	Silicon Replaceable by	1N2862	5001-10309
D644A,B,C,D	152-0066-00	Silicon	1N3194	10310-up
D663	152-0066-00	Silicon	1N3194	X12500-up
D664	152-0066-00	Silicon	1N3194	X12500-up
D720	152-035	Silicon	1N1563A	
D721	152-035	Silicon	1N1563A	
D745	*152-0107-00	Silicon Replaceable by	1N647	X8270-up
D837	152-0066-00	Silicon	1N3194	X11270-up
D838	*152-047	Silicon Replaceable by	1N2862	5001-10309
D838	152-0066-00	Silicon	1N3194	10310-up
D839	*152-047	Silicon Replaceable by	1N2862	5001-10309
D839	152-0066-00	Silicon	1N3194	10310-up

Fuses

F601	159-005	3 Amp	3AG	Slo-Blo 117v oper 50 & 60 cycle	
F601	159-041	1.25 Amp	3AG	Slo-Blo 234v oper 50 & 60 cycle	
F720	159-023	2 Amp	3AG	Slo-Blo	5001-11449
F720	159-0021-00	2 Amp	3AG	Fast-Blo	11450-11597
F720	159-0023-00	2 Amp	3AG	Slo-Blo	11598-up

Inductors

L860	Use	*108-285	Beam Rotator
------	-----	----------	--------------

Resistors

Resistors are fixed, composition, $\pm 10\%$ unless otherwise indicated.

R601†	311-340	50 Ω		Var	SCALE ILLUM	5001-12499
R601†	311-0672-00	50 Ω		Var	SCALE ILLUM	12500-up
R602	308-142	30 Ω	3 w		WW 5%	
R603	304-330	33 Ω	1 w			
R609	302-106	10 meg	1/2 w			
R610	302-104	100 k	1/2 w			
R611	302-102	1 k	1/2 w			
R612	302-272	2.7 k	1/2 w			
R616	311-015	10k		Var	WW -100 VOLTS	
R617	308-186	80 k	1/2 w		WW 1%	5001-10059
R617	308-0186-01	80 k	1 w		WW 1%	10060-up
R618	308-226	10 k	1/2 W		WW 1%	
R619	302-224	220 k	1/2 w			
R624	302-473	47 k	1/2 w			
R625	302-222	2.2 k	1/2 w			
R626	302-184	180 k	1/2 w			
R627	302-102	1 k	1/2 w			

† Concentric with SW601. Furnished as a unit.

Ckt. No.	Tektronix Part No.	Resistors (Cont'd)		S/N Range
		Description		
R628	308-176	4k	20 w	WW 5%
R632	302-102	1 k	1/2 w	
R633	302-473	47 k	1/2 w	
R635	301-302	3 k	1/2 w	5%
R640	304-100	10Ω	1 w	
R642	304-100	10Ω	1 w	
R644	304-100	10Ω	1 w	
R650	309-101	330 k	1/2 w	Prec 1%
R651	309-162	250 k	1/2 w	Prec 1%
R652	302-102	1 k	1/2 w	
R653	302-225	2.2 meg	1/2 w	
R654	302-474	470 k	1/2 w	
R655	302-685	6.8 meg	1/2 w	
R656	311-068	500 k	2 w	Var. +125 VOLTS
R657	302-684	680k	1/2 w	
R658	302-273	27 k	1/2 w	
R659	302-333	33k	1/2 w	
R663	302-102	1 k	1/2 w	
R664	302-102	1 k	1/2 w	
R666	308-176	4 k	20 w	WW 5%
R667	308-176	4k	20 w	WW 5%
R670	309-156	1.024 meg	1/2w	Prec 1%
R671	309-053	333 k	1/2 w	Prec 1%
R672	302-102	1 k	1/2 w	
R673	302-105	1 meg	1/2w	
R675	302-825	8.2 meg	1/2 w	
R676	311-068	500 k	2 w	Var. +300 VOLTS
R677	304-224	220 k	1 w	
R678	302-394	390k	1/2 w	
R679	302-333	33k	1/2 w	
R729	302-823	82 k	1/2 w	
R730	311-068	500 k	2 w	Var. -12.2 VOLTS
R731	309-104	2.05 k	1/2 w	Prec 1%
R732	310-115	15k	1 w	Prec. 1%
R733	302-564	560 k	1/2 w	
R733	301-394	390 k	1/2 w	5% 5001-5159 5160-up
R734	302-334	330k	1/2 w	
R735	302-272	2.7k	1/2 W	
R737	302-151	1500	1/2w	
R744	308-231	220 0	3 w	WW 5%
R749	3030563-00	-56 k	1w	5% X8270-up
R754	302-471	470	1/2 w	
R759	302-104	100 k	1/2 w	
R770	302-564	560k	1/2 w	
R781	316-470	47 0	1/4 w	5001-12499X
R782	316470	470	1/4 w	5001-12499X
R783	316470	47	1/4 w	5001-12499X
R784	31670	470	1/4 w	5001-12499X
R801	306-681	680 n	2 w	
R802	302-562	5.6 k	1/2 w	
R803	306-273	27 k	2 w	

(D)

Resistors (Cont'd)

Ckt. No.	Tektronix Part No.	Description	S/N Range	
R806	302-104	100 k 1/2 w		
R807	302-472	4.7 k 1/2 w		
R813	302-101	100Ω 1/2 w		
R815	302-474	470 k 1/2 w		
R816	302-102	1 k 1/2 w		
R831	302-104	100 k 1/2 w		
R832	302-106	10 meg 1/2 w		
R833	311-349	2 meg	Var.	INTENSITY
R834	302-105	1 meg 1/2 w		
R835	Use *050-115	Replacement Kit		5001-5609
R835†	(3) 306.565	5.6 meg 2w		5610-up
	(2) 306485	6.8 meg .2w		
R836	302-223	22 k 1/2 w		
R837	302-471	470 a 1/2 w		
R838	301-242	2.4 k 1/2 w		5%
R839	302-104	100k 1/2 w		
R840	301-125	1.2 meg 1/2 w		5%
R841	311-042	2 meg	Var.	HIGH VOLTAGE
R842	Use *050-147	Replacement Kit		5001-5609
R842††	(3) 306-395	3.9 mer 2w		5610-up
R844	311-254	5 meg .2 w	Var.	FOCUS
R846	304-225	2.2 meg 1 w		
R849	302-223	22k 1/ w		
R851	302-104	100 k 1/ w		
R852	302-273	27 k 1/ w		
R853	302-471	470 Ω 1/ w		
R854	302-105	1 meg 1/2 w		
R860	311-007	2 x 1 k	Var.	ALIGNMENT
R861	302-680	68 Ω 1/2 w		
R862	302-823	82 k 1/2 w		
R863	302-823	82k 1/ w		
R864	311-206	250 k	Var.	ASTIGMATISM
R865	311-026	100 k	Var.	GEOMETRY
R870	301-393	39 k 1/2 w		5%
R871	311-315	20 k	Var.	CAL AMPL
R872	301-154	150 k 1/2 w		5%
R873	302-103	10 k 1/2 w		
R876	301-153	15 k 1/2 w		5%
R876	323-0306-00	15k 1/2 w	Prec.	1% 5001-13129
R877	301-183	18k 1/2 w		5% 13130-up
R877	323-0314-00	18.2 k 1/2 w	Prec.	1% 13130-up
R878	301-564	560 k 1/2 w		5% 5001-13129
R878	323-0455-00	536 k 1/2 w	Prec.	1% 13130-up
R879	Use 301-114	110k 1/2 w		5% 5001-13129
R879	3230389-00	110 k 1/2 w	Prec.	1% 13130-up
R883	305-223	22 k 2 w		5%
R885	310-066	18k 1 w	Prec.	1%
R886	309-30	1.8 k 1/2 w	Prec.	1%
R887	309-072	180Ω 1/2 w	Prec	1%
R88 8	3094064	20Ω 1/2 w	Prec	1%

† S/N 5610-up

*050-115 may be used

††S/N 5610-up

*050-147 may be used

Resistors (Cont)

R890	309-030	1.8 k	1/2 W	Prec.	1%
R891	309-072	180 Ω	1/2 w	Prec.	1%
R892	309-064	20 Ω	1/2 w	Prec.	1%
R898	309-178	250 Ω	1/2 w	Prec.	1%
R899	*308-090	1/4 Ω	1 w	WW	1%

Switches

Ckt. No.	Tektronix Part No.		Description	S/N Range
	Unwired	Wired		
SW601 †	311-340		POWER ON-OFF	5001-12499
SW601 †		311-0672-00	POWER ON-OFF	12500-up
SW854	260449		Slide	
SW870	260-394	*262-515	Rotary	CRT CATHODE SELECTOR CALIBRATOR

Thermal Cutout

TK601	260-246	Thermal Cutout 123 ^o
-------	---------	---------------------------------

Transformers

T601	*120-280	L.V. Power
T801	*120-297	H.V. Power

Transistors

Q624	151-087	Selected from 2N1131
Q734	151-040	2N1302
Q744	151-042	2N1378
Q757	Use 151-0165-00	2N3614

Electron Tubes

V609	154-291	0G3	
V627	154-307	7233	
V634	154-187	6DJ8	
V654	154-022	6AU6	
V667	154-056	6080	
V674	154-022	6AU6	
V800	154467	6CZ5	
V814	154-046	12BH7	
V822	154-051	5642	
V832	154.051	5642	
V859 † †	Use *154-449	T5032-31-1 CRT Standard Phosphor	5001-6885
V859	*154-449	T5032-31-1 CRT Standard Phosphor	6886-up
V884	154-278	6BL8	

† Concentric with R601. Furnished as a unit.

† † S/N 5001-6885 add '050-214 kit.

(D)

TYPE R561B

Values are fixed unless marked Variable.

Ckt. No.	Tektronics Part No.	Serial/Model No. Eff	Disc	Description
Bulbs				
B4	150-0047-00			Incandescent #CN8-398
B5	150-0047-00			Incandescent #CN8-398
86	150-0047-00			Incandescent #CN8-398
B7	150-0045-00			Incandescent #685
B209	150-0030-00			Neon, NE 2V
8277	150-0030-00			Neon, NE 2V
B278	150-0030-00			Neon, NE 2V
B279	150-0030-00			Neon, NE 2V

CapacitorsTolerance \pm 20% unless otherwise indicated.

C9	290-0319-00			1300 μ F	Elect	150V	+75%-10%
C11	293-0245-00			1.5 μ F	Elect	10V	10%
C16	281-0523-00			100 μ F	Cer	350V	
C24	281-0546-00			330 μ F	Cer	500V	10%
C31	290-0271-00	B010100	B139999	9 μ F	Elect	125V	+20%-15%
C31	290-0486-00	B140000		6.8 μ F	Elect	100V	10%
C36	290-0398-00			10,000 μ F	Elect	25 V	+100%-10%
C42	290-0267-00			1 μ F	Elect	35 V	
C47	290-0201-00			100 μ F	Elect	15 V	
C50	281-0525-00			470 μ F	Cer	500 V	
C54	290-0318-00			650 μ F	Elect	250 V	+75%-10%
C62	283-0079-00	B010100	B129999	0.01 μ F	Cer	250 V	
C62	283-0267-00	B130000		0.01 μ F	Cer	500 V	
C65	281-0638-00	B010100	B139999	240 pF	Cer	500 V	5%
C65	283-0104-00	B140000		2000 pF	Cer	500 V	5%
C75	290-0305-00	XB100000	B139999X	3 μ F	Elect	150 V	
C78	290-0181-00			290 μ F	Elect	350 V	
C82	283-0079-00	B010100	B129999	0.01 μ F	Cer	250 V	
C82	283-0267-00	B130000		0.01 μ F	Cer	500 V	
C88	281-0536-00			1000 pF	Cer	500 V	10%
C97 A, B	290-0089-00			3 X 20 μ F	Elect	350 V	
C102	281-0027-00			0.7-3 pF, Var Tub.			
C109	281-0027-00			0.7-3 pF, Var Tub.			
C157	*285-0758-00			0.05 μ F	MT	400 V	2%
C203	283-0000-00			0.001 μ F	Cer	500 V	
C209	283-0057-00			0.1 μ F	Cer	200 V	+80%-20%
C215	283-0092-00	B010100	B099999	0.03 μ F	Cer	200 V	+80%-20%
C215	285-0628-00	B100000		0.033 μ F	PTM	300 V	
C217	285-0572-00			0.1 μ F	PTM	200 V	
C221	283-0071-00			0.0068 μ F	Cer	5000 V	
C223	283-0008-00			0.1 μ F	Cer	500 V	

Capacitors (cont)

Ckt. No.	Tektronics Part No.	Serial/Model No.		Description	
		Eff	Disc		
C229	283-0071-00			0.0068 μ F	Cer 5000 V
C232	283-0071-00			0.0068 μ F	Cer 5000 V
C250	283-0071-00			0.0068 μ F	Cer 5000 V
C260	283-0071-00			0.0068 μ F	Cer 5000 V
C262	283-0071-00			0.0068 μ F	Cer 5000 V
C275	283-0071-00			0.0068 μ F	Cer 5000 V
Semi-conductor Device, Diodes					
D8A,B,C,D (4)	152-0066-00			Silicon	1N3194
D10	152-0212-00			Zener	1N936 9V, 5%, TC
D19	*152-0185-00			Silicon	Replaceable by 1N4152
D25	152-0333-00			Silicon	High Speed and Conductance
D31	152-0066-00			Silicon	1N3194
D35A	*152-0198-00			Silicon	Replaceable by MR-1032A
D35B	*152-0198-00			Silicon	Replaceable by MR-1032A
D47	152-0066-00			Silicon	1N3194
D53A,B,C,D (4)	152-0066-00			Silicon	1N3194
D62	*152-0185-00			Silicon	Replaceable by 1N4152
D65	*152-0107-00			Silicon	Replaceable by 1N647
D68	*152-0107-00	XB040000		Silicon	Replaceable by 1N647
D70	*152-0107-00	XB040000		Silicon	Replaceable by 1N647
D75	152-0066-00			Silicon	1N3194
D76	152-0066-00			Silicon	1 N3194
D77A,D,C,D (4)	152-0066-00			Silicon	1N3194
D80	*152-0185-00			Silicon	Replaceable by 1N4152
D88	*152-0107-00			Silicon	Replaceable by 1N647
D90	*152-0107-00	XBC40000	Silicon		Replaceable by 1N647
D91	*152-0107-00	XB040000	Silicon		Replaceable by 1N647
D95	152-0066-00			Silicon	1N3194
D151	*152-0185-00			Silicon	Replaceable by 1N4152
D159	*152-0185-00			Silicon	Replaceable by 1N4152
D161	*152-0185-00			Silicon	Replaceable by 1N4152
D164	*152-0185-00	B010100	B019999	Silicon	Replaceable by 1N4152
D164	*152-0107-00	B020000		Silicon	Replaceable by 1N647
D168	152-0333-00			Silicon	High Speed and Conductance
D204	*152-0107-00			Silicon	Replaceable by 1N647
D212	*152-0185-00			Silicon	Replaceable by 1 N4152
D214	*152-0107-00	XB100000		Silicon	Replaceable by 1N647
D217	152-0333-00			Silicon	High Speed and Conductance
D221	152-0218-00	B010100	B029999	Silicon	10,000 V 20 mA
D221	152-0408-00	B030000		Silicon	10,000 V 5 mA
D260	152-0218-00	B010100	B029999	Silicon	10,000 V 20 mA
D260	152-0408-00	B030000		Silicon	10,000 V 5 mA
D271	152-0066-00			Silicon	1N3194
D272	152-0066-00			Silicon	1N3194
D275	152-0066-00			Silicon	1N3194
Fuses					
F1	159-0026-00			3.2 A	3AG Slo-Blo
F2	159-0023-00			2A	3AG Slo-Blo
F9	159-0083-00			150 mA	3AG Fast-Blo

Connectors

Ckt. No.	Tektronics Part No.	Serial/Model No.		Description
		Eff	Disc	
J11	131-0148-00			24 Contact, Female
J21	131-0148-00			24 Contact, Female
J183	131-0274-00			BNC
J255	131-0126-00			BNC
Inductor				
L259	*108-0495-00			CRT Trace Rotator
Transistors				
Q12	151-0190-00			Silicon 2N3904
Q14	151-0190-00			Silicon 2N3904
Q24	151-0190-00			Silicon 2N3904
Q28	*151-0136-00			Silicon Replaceable by 2N3053
Q30	151-0190-00			Silicon 2N3904
Q32	151-0149-00			Silicon 2N3441
Q38	151-0190-00			Silicon 2N3904
Q44	*151-0192-00			Silicon Replaceable by MPS-6521
Q46	*151-0192-00			Silicon Replaceable by MPS-6521
Q49	*151-0136-00			Silicon Replaceable by 2N3053
Q51	151-0165-00			Germanium 2N3614
Q58	151-0190-00			Silicon 2N3904
Q60	151-0190-00			Silicon 2N3904
Q66	*151-0253-00	B010100	B139999	Silicon Replaceable by 2N3439
066	*151-0150-00	B140000		Silicon Selected from 2N3440
Q68	*15140253-00	B010100	B139999	Silicon Replaceable by 2N3439
Q68	*151-0150-00	B140000		Silicon Selected from 2N3440
Q70	151-0190-00			Silicon 2N3904
Q74	*151-0256-00			Silicon Tek Spec
Q84	151-0190-00			Silicon 2N3904
Q86	151-0190-00			Silicon 2N3904
Q88	*151-0253-00	B010100	B139999	Silicon Replaceable by 2N3439
Q88	*151-0150-00	B140000		Silicon Selected from 2N3440
Q90	*151-0253-00	B010100	B139999	Silicon Replaceable by 2N3439
Q90	*151-0150-00	B140000		Silicon Selected from 2N3440
Q91	151-0190-00			Silicon 2N3904
Q96	*151-0256-00			Silicon Tek Spec
Q151	*151-0216-00			Silicon Replaceable by MPS-6523
Q159	*151-0216-00			Silicon Replaceable by MPS-6523
Q162	151-0250-00			Silicon 2N5184
Q211	151-1005-00			Silicon FET
Q214	*151-0228-00			Silicon Tek Spec
Q219	151-0201-00			Silicon 2N3739

Resistors

Resistors are fixed, composition, $\pm 10\%$ unless otherwise indicated.

R4	311-0377-00	25 Ω , Var		
R7	302-0330-00	33 Ω	1/2 W	
R8	307-0093-00	1.2 Ω	1/2 W	5%
R9	304-0333-00	33 Ω	1 W	

Resistors (cont)

Ckt. No.	Tektronics Part No.	Serial/Model No.		Description		
		Eff	Disc			
R10	305-0123-00			12 k Ω	2W	5%
R11	316-0102-00			1 k Ω	1/4 W	
R12	316-0101-00			100	1/4 W	
R13	323-0353-00			46.4 k Ω	1/4 W	Prec 1%
R14	323-0394-00			124 k Ω	1/2 W	Prec 1%
R16	316-0101-00			100 Ω	1/4 W	
R18	321-0268-08			6.04k Ω	1/8 W	Prec 1%
R19	321-0235-00			2.74k Ω	1/8 W	Prec 1%
R20	323-0365-08			61.9k Ω	1/2 W	Prec 1%
R21	321-0445-00			422 k Ω	1/8 W	Prec 1%
R23	311-0465-00			100 k Ω , Var		
R25	315-0154-00			150k Ω	1/4 W	5%
R26	315-0823-00			82 k Ω	1/4 W	5%
R29	316-0181-00			180 Ω	1/4 W	
R30	315-0132-00			1.3k Ω	1/4 W	5%
R31	315-0204-00	B010100	B119999	200 Ω	1/4 W	5%
R31	315-0184-00	B120000		180k Ω	1/4 W	5%
R33	307-0103-00			2.7 Ω	1/4 W	5%
R36	304-0103-00			10k Ω	1 W	
R37	316-0271-00			270 Ω	1/4 W	
R38	308-0242-00			0.25 Ω	5 W	WW 5%
R39	316-0101-00			100 Ω	1/4 W	
R40	323-0371-00			71.5 k Ω	1/2 W	Prec 1%
R42	321-0296-03			11.8 k Ω	1/8 W	Prec 1/4%
R43	323-0752-03			85 k Ω	1/2 W	Prec 1/4 %
R44	316-0101-00			100 Ω	1/4 W	
R45	323-0333-00			28.7 k Ω	1/2 W	Prec 1%
R47	316-0101-00			100 Ω	1/4 W	
R49	302-0470-00			47 Ω	1/2 W	
R50	302-0100-00			10 Ω	1/2 W	
R52	307-0024-00			2.7 Ω	1/2 W	
R53	307-0024-00			2.7 Ω	1/2 W	
R54	304-0473-00			47 k Ω	1 W	
R56	316-0101-00			10 Ω	1/4 W	
R57	323-0430-00			294 k Ω	1/2 W	Prec 1%
R59	323-0356-00			49.9 k Ω	1/2 W	Prec 1%
R61	316-0101-00			100 Ω	1/4 W	
R62	323-0753-02			121.3 k Ω	1/2 W	Prec 1/2%
R63	323-0384-02			97.6	1/2 W	Prec 1/2%
R65	316-0151-00	B010100	B139999	150 Ω	1/4 W	
R65	316-0471-00	B140000		470 Ω	1/4 W	
R66	302-0224-00			220 k Ω	1/2 W	
R69	315-0511-00			510 k Ω	1/4 W	5%
R70	315-0104-00			100 k Ω	1/4 W	5%
R72	316-0181-00			180 Ω	1/4 W	
R75	307-0103-00			2.7 Ω	1/4 W	5%
R77	307-0024-00			2.7 Ω	1/2 W	

Resistor (cont)

Ckt. No.	Tektronics Part No.	Serial/Model No.		Description		
		Eff	Disc			
R78	304-0104-00			100 k Ω	1 W	
R80	323-1429-02			291 k Ω	1/2 W	Prec 1/2%
R81	323-0384-02			97.6 k Ω	1/2 W	Prec 1/2%
R83	316-0101-00			100 Ω	1/4 W	
R85	323-0356-00			49.9 k Ω	1/2 W	Prec 1%
R86	323-0430-00			294 k Ω	1/4 W	Prec 1%
R87	316-0101-00			100 Ω	1/4 W	
R88	316-0471-00			470 Ω	1/4 W	
R89	302.0224-00			220 k Ω	1/2 W	
R90	315-0162-00			1.6 k Ω	1/4 W	5%
R91	315-0564-00			560 k Ω	1/4 W	5%
R92	315-0122-00			1.2 k Ω	1/4 W	5%
R94	307-0103-00			2.7 Ω	1/4 W	5%
R95	316-0181-00			180 Ω	1/4 W	
R101	308-0124-00	B010100	B049999	6 k Ω	10 W	WW 5%
R101	308-0021-00	B050000		4.5 k Ω	10 W	WW 5%
R150	323-0403-00			154 k Ω	1/2 W	Prec 1%
R153	308-0501-00			5.45 k Ω	1.5 W	WW 1%
R154	311-0826-00			750 Ω , Var		
R156	315-0624-00			620 k Ω	1/4 W	5%
R158	323-0404-00			158 k Ω	1/2 W	Prec 1%
R160	315-0224-00			220 k Ω	1/4 W	5%
R164	308-0515-00			14.5k Ω	5 W	WW 1%
R166	311-0732-00			1 k Ω , Var		
R167	308-0492-00			8.15k Ω	3 W	WW 1%
R170	323-0741-03			3.6 k Ω	1/2 W	Prec 1/4%
R171	321-0773-03			400 Ω	1/8 W	Prec 1/4%
R173	321-0772-02			63 Ω	1/8 W	Prec 1/2%
R175	321-0774-03			4.5 k Ω	1/8 W	Prec 1/4%
R176	321-0775-03			45 k Ω	1/8 W	Prec 1/4%
R178	308-0488-00			5 Ω	2.5 W	WW 2%
R179	308-0499-00			0.5 Ω	2.5 W	WW
R181	321-0771-03			50 Ω	1/8 W	Prec 1/4%
R183	*308-0090-00			0.25 Ω	1 W	WW
R200	315-0103-00			10 k Ω	1/4 W	5%
R201	322-0464-00			665 k Ω	1/4 W	Prec 1 %
R203	315-0474-00			470 k Ω	1/4 W	5%
R204	316-0336-00			33 M Ω	1/4 W	
R206	311-0465-00			100 k Ω , Var		
R208	316-0225-00			2.2 M Ω	1/4 W	
R210	315-0104-00			100 k Ω	1/4 W	5%
R211	315-0154-00			150 k Ω	1/4 W	5%
R213	316-0102-00			1 k Ω	1/4 W	
R214	302-0393-00	XB100000		39 k Ω	1/2 W	
R215	316-0333-00			33k Ω	1/4 W	
R216	302-0333-00			33 k Ω	1/2 W	
R217	316-0105-00			1 M Ω	1/4 W	

Resistors (cont)

Ckt. No.	Tektronics Part No.	Serial/Model No. Eff	Disc	Description	
R218	301-0510-00		51 Ω	1/2 W	5%
R223	316-0102-00		1 kΩ	1/4 W	
R225	311-0018-00		20 kΩ, Var		
R226	305-0563-00		56 kΩ	2W	5%
R227	315-0334-00		330 kΩ	1/4 W	5%
R228	315-0134-00		130 kΩ	1/4 W	5%
R229	316-0223-00		22 kΩ	1/4 W	
R231	302-0104-00		100 kΩ	1/2 W	
R233	305-0475-00		4.7 MΩ	2W	5%
R234	305-0475-00		4.7 MΩ	2W	5%
R235	303-0365-00		3.6 MΩ	1W	5%
R236	304-0106-00		10 MΩ	1W	
R237	311-0254-00		5 MΩ, Var		
R238	301-0225-00		2.2 MΩ	1/2 W	5%
R244	316-0564-00		560 kΩ	1/4 W	
R246	302-0104-00		100 kΩ	1/2 W	
R248	316-0273-00		27 kΩ	1/4 W	
R250	316-0471-00		470 Ω	1/4 W	
R251	316-0105-00		1 MΩ	1/4 W	
R256	311-4369-00		100 kΩ, Var		
R257	311-0206-00		250 kΩ, Var		
R259	311-0007-00		2 X 1 kΩ, Var		
R261	316-0104-00		100 kΩ	1/4 W	
R263	305-0825-00		8.2 MΩ	2W	5%
R264	305-0825-00		82 MΩ	2W	5%
R265	305-0825-00		8.2 MΩ	2W	5%
R266	305-0825-00		8.2 MΩ	2W	5%
R269	311-0469-00		1 MΩ, Var		
R270	316-0223-00		22 kΩ	1/4 W	
R273	302-0104-00		100 kΩ	1/2 W	
R274	315-0242-00		24 kΩ	1/4 W	5%
R275	316-0471-00		470Ω	1/4 W	
R276	316-0105-00		1 MΩ	1/4 W	

Switches

	Wired or Unwired		
SW1	260-0276-00	Toggle	POWER
SW2 ¹			
SW3 ¹			
SW150	Wired *262483900	Rotary	1kHz CALIBRATOR
SW150	260-0999-00	Rotary	1kHz CALIBRATOR
SW255	260-0450-00	Slide	CRT CATHODE SELECTOR

¹See Mechanical Parts List. Line Voltage Selector Body (*204-0279-00).

Thermal Cut-out

Ckt. No.	Tektronics Part No.	Serial/Model No. Eff	Disc	Description
-----------------	----------------------------	-----------------------------	-------------	--------------------

TK1	260-0551-00			187° F
-----	-------------	--	--	--------

Transformers

T1	*120-0575-00			LV. Power
T220	*120-0466-00	B010100	B079999	H.V. Power
T220	*120-0466-01	B080000	B149999	H.V. Power
T220	*120-0466-02	B150000		H.V. Power

Electron Tube

V249	*154-0531-00			T5611-31-1	CRT Standard Phosphor
------	--------------	--	--	------------	-----------------------

SECTION 8

MECHANICAL PARTS LIST

TYPE RM561A

A list of abbreviations and special symbols in use throughout this manual will be found immediately preceding the Electrical Parts List, Section 7. Abbreviations and symbols used in this manual are based on or taken directly from IEEE Standard 260 "Standard Symbols for Units", MIL-STD-12B and other standards of the electronics industry. Parts ordering information is also located immediately preceding Section 7.

(A)(B)

EXPLODED VIEW

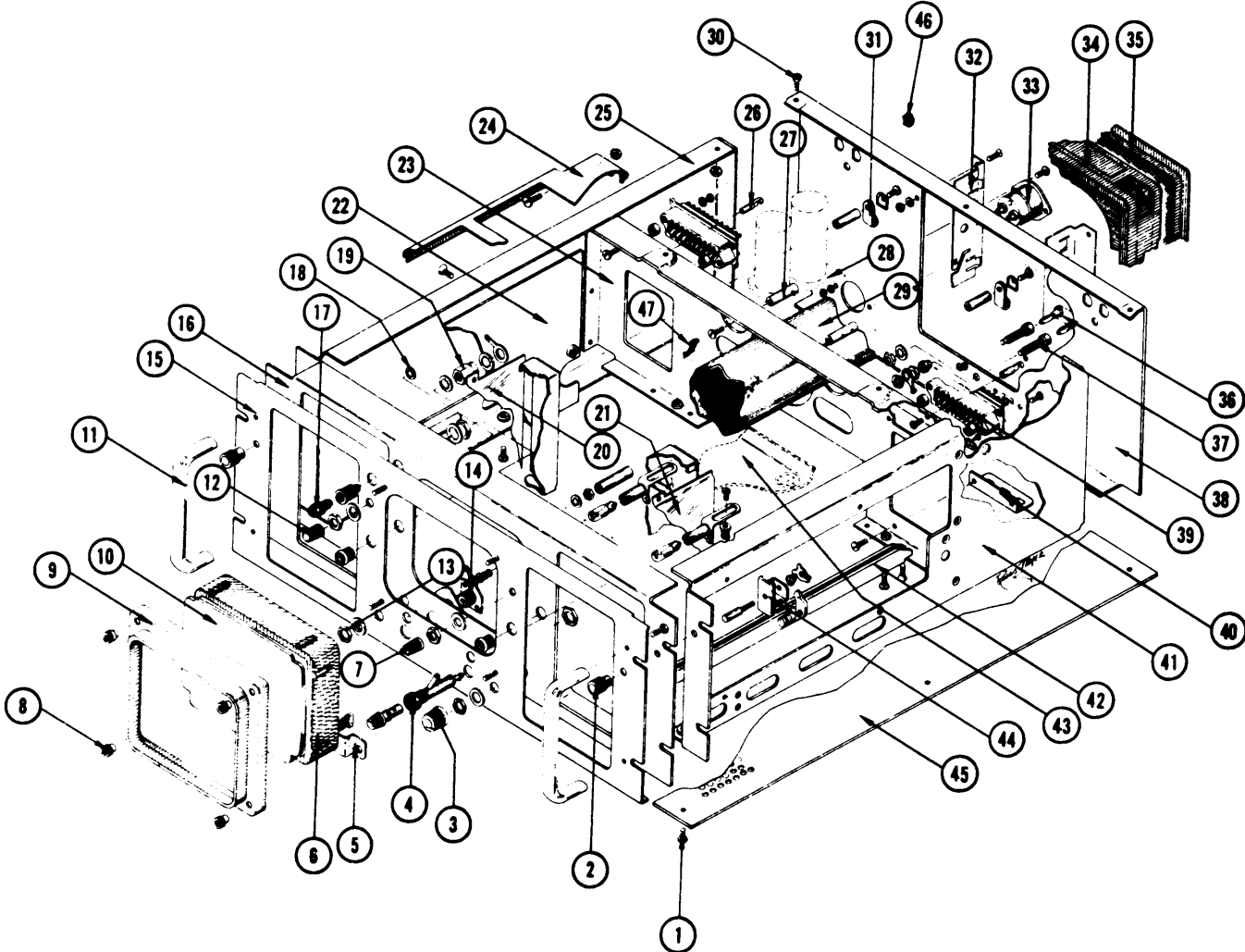

(A)(C)

EXPLODED VIEW

REF. NO.	PART NO.	SERIAL/MODEL NO.		QTY	DESCRIPTION
		EFF.	DISC.		
1	211-0565-00			20	SCREW, 6-32 x 1/4 in. truss HS
2	366-0109-00			2	KNOB, PLUG-IN SECURING
3	366-0113-00	5001	6209	1	KNOB, POWER AND SCALE ILLUM.
	366-0220-00	6210		1	KNOB, POWER AND SCALE ILLUM. knob includes:
	213-0004-00	5001	6209	1	SCREW, set, 6-32 x 3/16 inch HSS
	213-0020-00	6210		1	SCREW, set, 6-32x 1/8 inch HSS
	210-0413-00	5001	6209	1	NUT, hex, brass, 3/8-32 x 1/2 in.
	210-0590-00	6210		1	NUT, hex, brass, 3/8-32 x 7/16 in.
4	352-0014-00			1	HOLDER, fuse, with hardware
	200-0237-00	5001	6279X	1	COVER, insulation, fuse holder, clear
5	352-0049-00	5001	6885	1	HOLDER, reflector shield
	214-0442-00	6886		1	SPRING, light pipe
	337-0540-00	5001	6885	1	SHIELD, reflector
	387-0934-00	6886		1	PLATE, light reflector
6	354-0181-00	5001	6885	1	RING, CRT shockmount, black neoprene
	124-0167-00	6886	10337	1	STRIP, neoprene
	348-0090-00	10338		4	CUSHION, sponge, CRT
7	366-0153-00			1	KNOB, INTENSITY
	210-0583-00			1	NUT, hex, brass, 1/4-32 x 5/1 in.
	210-0940-00			1	WASHER, steel, 1/4 in.
	200-0608-00	X11015		1	COVER, variable resistor
8	210-0571-00			4	NUT, graticule cover, 3 in. alum. 10-32 knurled
9	200-0426-00			1	COVER, trim and graticule assembly
10	337-0539-00	5001	6885X	1	SHIELD, implosion, plexiglass
	337-0586-01	X8580	1131X	1	SHIELD, crt light
11	367-0032-00			2	HANDLE, nickel plated
	213-0090-00			2	SCREW, 10-32x 1/2 in. hex
12	366-0153-00			1	KNOB, FOCUS
	210-0583-00			1	NUT, hex, brass, 1/4-32 x 5/16 in.
	210-0940-00			1	WASHER, steel, 1/4 in.
13	366-0113-00			1	KNOB, CALIBRATOR
	210-0413-00			1	NUT, hex, brass, 3/8-32 x 1/2 in.
	210-0840-00			1	WASHER, steel
	210-0013-00			1	LOCKWASHER, steel, internal 3/8 x 11/16 in.
	200-0608-00	X11015		1	COVER, variable resistor
14	131-0064-00	5001	5279	1	CONNECTOR, chassis mount. cal. out coax
	131-0279-00	5280		1	CONNECTOR, BNC
	406-0244-00			1	Mounting Hardware: (not included) BRACKET, nylon molded, coax insulator
	210-0224-00			1	LUG, solder, #10, non-locking
	210-0812-00			2	WASHER, fiber #10
	210-0004-00			2	LOCKWASHER, steel, internal #4
	210-0406-00			2	NUT, hex, brass, 4-40 x 3/16 in.
	210-0961-00	X5280	6278X	1	WASHER, plastic, 3/8 ID x 13/16 inch OD
15	333-0731-00			1	PANEL, front
16	387-0696-00			1	PLATE, subpanel, front
17	136-0031-00	5001	12659	1	SOCKET, light, red, assembly
	136-0031-01	12660		1	SOCKET, light, green, assembly
18	210-0011-00			2	LOCKWASHER, steel, internal 1/4 in.

(A)(H)

Exploded View (Cont'd)

REF. NO.	PART NO.	SERIAL/MODEL NO.		QTY	DESCRIPTION
		EFF.	DISC.		
19	210-0494-00 210-0013-00 358-0010-00 210-0012-00 210-0207-00 200-0247-00	5001	7909X	2	NUT, hex, alum. 3/8-32 x 1/2 x 11/16 in.
				2	LOCKWASHER, internal 3/8 x 11/16 in.
				2	BUSHING, 3/8-32x 9/16 in.
				2	LOCKWASHER, pot, internal 3/8 x 1/2 in.
				2	LUG, solder, pot, plain, 3/8 in.
				2	COVER, pot
20	337-0536-00			1	SHIELD, Focus and Intensity, left
21	337-0535-00			1	SHIELD, Focus and Intensity, right
22	387-0450-00 387-0449-00 ----- 211-0504-00 211-0541-00			1	PLATE, left side cover
				1	PLATE, right side cover
				-	Mounting Hardware: (not included)
				8	SCREW, 6-32 x 1/4 in. BHS
				8	SCREW, 6-32 x 1/4 in. FHS, 100° CSK
23	387-0716-00 ----- 212-0002-00 210-0458-00			1	PLATE, bulkhead
				-	Mounting Hardware: (not included)
				10	SCREW, 8-32 x 1/4 in. FHS, 100° CSK
				10	NUT, keps, 8-32 x 11/32 in.
24	406-0716-00 ----- 212-0004-00 212-0070-00 210-0458-00			2	BRACKET, plug-in
				-	Mounting Hardware: (not included)
				2	SCREW, 8-32 x 5/16 in. BHS
				2	SCREW, 8-32 x 5/16 in. FHS
				4	NUT, keps, 8-32 x 11/32 in.
25	387-0447-00			1	PLATE, side left
26	352-0015-00 213-0045-00			2	HOLDER, nylon, for coil form
				2	SCREW, 4-40 x 5/16 in. Pan Head
27	385-0113-00 211-0507-00			2	ROD, nylon, 5/16 x 1 1/8 in.
				2	SCREW, 6-32 x 5/16 in BHS
28	Pg. 8-8				CHASSIS, rear
29	Pg. 8-12				CRT Shield
30	212-0070-00 210-0458-00			32	SCREW, 8-32 x 5/16 in. FHS
				32	NUT, keps, 8-32 x 11/32 in.
31	385-0013-00 343-0004-00 210-0863-00 211-0507-00			2	ROD, nylon, 5/16 x 3/4 in.
				2	CLAMP, cable, 5/16 in., plastic
				2	WASHER, "D" Type for #10 screw
				4	SCREW, 6-32 x 5/16 in. BHS
32	351-0046-00 ----- 211-0538-00 210-0006-00 210-0407-00			2	GUIDE, fan clips
				-	Mounting Hardware: (not included)
				2	SCREW, 6-32 x 1/16 in. FHS, 100° CSK
				2	LOCKWASHER, internal #6
				2	NUT, hex, 6-32 x 1/4 in.
33	131-0150-00 131-0150-01 213-0041-00	5001 11860	11859	1	CONNECTOR, chassis mount, 3 wire
				1	CONNECTOR, chassis mount, 3 wire
				2	SCREW, 5-32 x 3/16 in. Pan H
34	119-0013-00 119-0026-00	5001 5133	5132	1	BLOWER, fan, assembly
				1	BLOWER, fan, assembly
35	378-0761-00			1	SCREEN, grille for fan
36	134-0012-00			1	PLUG, plated, banana male, twin
37	136-0139-00 136-0140-00 210-0898-00 210-0011-00 210-0223-00 210-0465-00			1	SOCKET, banana jack assembly, with red nylon cap
				1	SOCKET, banana jack assembly, with charcoal nylon cap
				1	WASHER, insulating, red
				1	LOCKWASHER, internal 1/4 in.
				1	LUG, solder, 1/4 in.
				3	NUT, hex, brass, 1/4-32 x 3/8 in.

(A)(H) i

EXPLODED VIEW (Cont'd)

REF. NO.	PART NO.	SERIAL/MODEL NO.		QTY	DESCRIPTION
		EFF.	DISC.		
38	387-0695-00	5001	6441	1	PLATE, rear
	387-0937-00	6442		1	PLATE, rear
39	212-0004-00			4	Mounting Hardware: (not included) SCREW, 8-32 x 5/16 in. BHS
	210-0458-00			4	NUT, keps, steel, 8-32 x 1 1/3 2 in.
	131-0148-00			2	CONNECTOR, chassis mount, 24 contact Mounting Hardware: (not included)
	211-0014-00			2	SCREW, 4-40 x 1/2 in. BHS
40	166-0029-00			2	TUBE, spacer, alum.
	210-0004-00			2	LOCKWASHER, steel, internal #4
	210-0406-00			2	NUT, hex, brass, 4-40 x 3/16 in.
	406-0893-00			1	BRACKET, pot mounting Mounting Hardware: (not included)
41	211-0504-00			2	SCREW, 6-32 x 1/4 in. BHS
42	387-0446-00			1	PLATE, side right
	351-0047-00			2	GUIDE, rail track, alum. Mounting Hardware: (not included)
43	211-0541-00			2	SCREW, 6-32x 1/4 in. FHS, 100° CKS
	210-0407-00			1	NUT, hex, brass, 6-32 x 1/4in.
44	Pg. 8-6				Chassis, front
44	214-0052-00	5001	6319	1	FASTENER, right, with stop assembly
	214-0424-00	6320		1	FASTENER, right, with stop assembly
	214-0053-00	5001	6319	1	FASTENER, left, with stop assembly
	214-0425-00	6320		1	FASTENER, left, with stop assembly Mounting Hardware: (not included)
45	210-0004-00			2	LOCKWASHER, steel, internal #4
	210-0406-00			2	NUT, hex, brass, 4-40 x 3/16 in.
	387-0452-00			2	PLATE, dust cover, top and bottom Mounting hardware: (not included)
46	211-0565-00			10	SCREW, 6-32 x 1/4 in. truss HS
47	134-0067-00	X6442		8	PLUG, grey nylon
	344-0111-00	X7730		1	CLIP, deflection lead

(A)(C) i

Front Chassis & Cable Harness

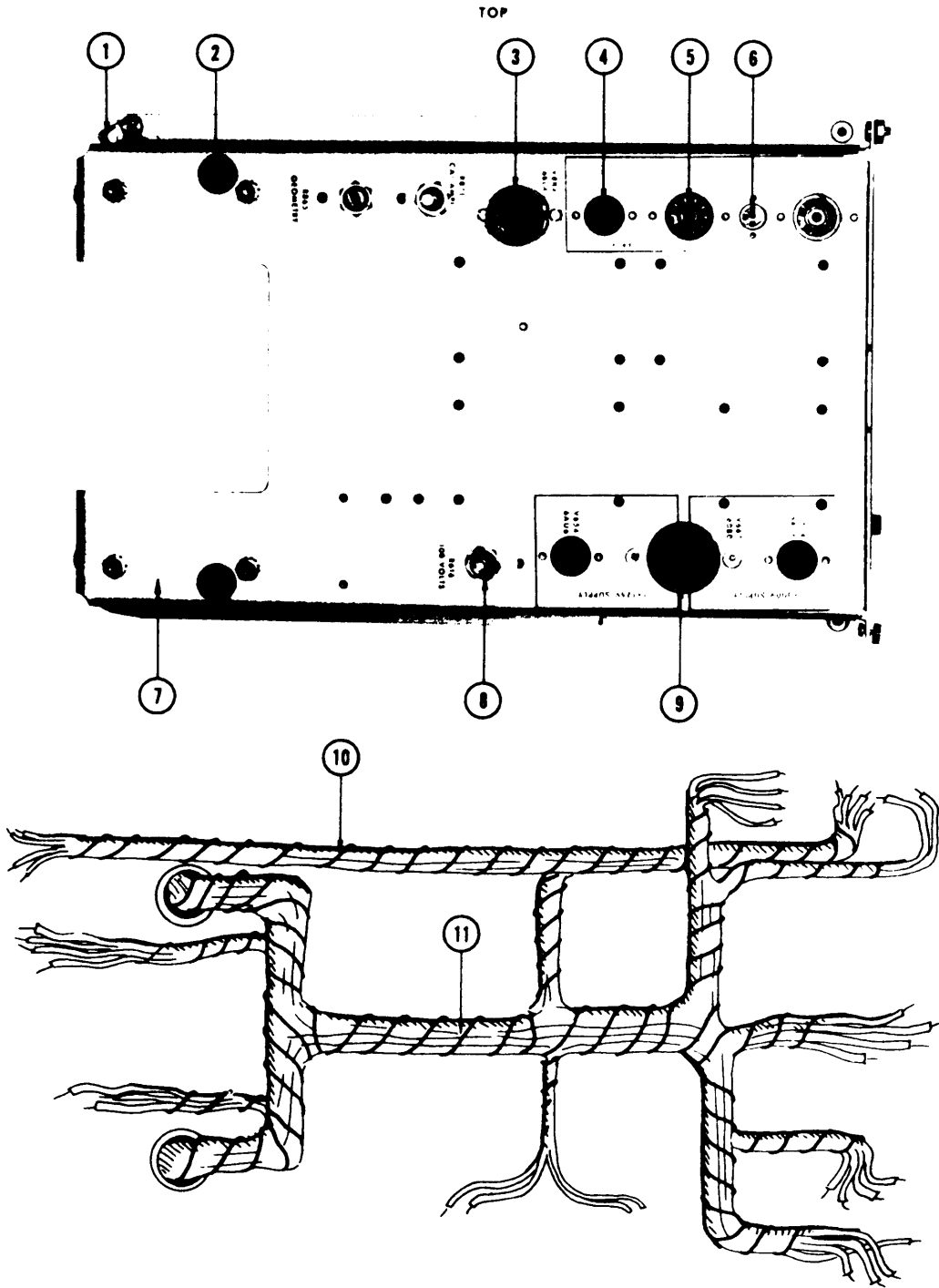

FRONT CHASSIS & CABLE HARNESS

REF. NO.	PART NO.	SERIAL/MODEL NO.		QTY	DESCRIPTION
		EFF.	DISC.		
1	344-0095-00			2	CLIP, grounding Mounting Hardware: (not included)
	211-0559-00			1	SCREW, steel, 6-32 x 3/8 in. FHS, 100° CSK
	210-0803-00			1	WASHER, steel, 6L x 3/8 in.
	210-00-0000			1	LOCKWASHER, steel, internal #6
	210-0407-00			1	NUT, hex, brass, 6-32 x 1/4 in.
2	348-0006-00			2	GROMMET, rubber, 3/4 in.
3	136-0022-00			2	SOCKET, STM9S Mounting Hardware: (not included)
	211-0033-00			2	SCREW, 4-40 x 5/16, in. Pan HS, with lockwasher
	210-0004-00			2	LOCKWASHER, steel internal #4
	210-0406-00			2	NUT, hex, brass, 4-40 x 3/16 in.
4	136-0008-00			3	SOCKET, STM7G Mounting Hardware: (not included)
	213-0044-00			2	SCREW, 5-32 x 3/16 in. Pan H, thread cutting
5	136-0015-00			2	SOCKET, STM9G Mounting Hardware: (not included)
	213-0044-00			2	SCREW, 5-32 x 3/16 in. Pan H, thread cutting
6	136-0095-00	5001	6639	1	SOCKET, 4 pin, transistor
	136-0181-00	6640		1	SOCKET, 3 pin transistor Mounting Hardware: (not included)
	213-0113-00	5001	6639	2	SCREW, 2-32 x 5/16 in. RHS, thread forming
	354-0234-00	6640		1	RING, locking, transistor socket
7	441-0448-00			1	CHASSIS, front Mounting Hardware: (not included)
	212-0004-00			6	SCREW, 832 x 5/16 in. BHS
	212-0070-00			2	SCREW, 8-32 x 5/16 in. FHS, phillips
	210-0458-00			4	NUT, keps, steel, 8-32 x 11/32 in.
8	210-0413-00			1	Pot Mounting Hardware: NUT, hex, brass, 3/8-32 x 1/2 in.
	210-0840-00			1	WASHER, steel
9	136-0013-00			1	SOCKET, STM8 Mounting Hardware: (not included)
	211-0538-00			2	SCREW, 6-32 x 5/16 in. FHS, 100° CSK, phillips
	210-000600			1	LOCKWASHER, steel, internal #6
	210-0203-00			1	LUG, solder, SE6, long
	210-0407-00			2	NUT, hex, brass, 6-32 x 1/4 in.
10	179-0699-00	5001 5969		1	CABLE harness
	179-0857-00	5970		1	CABLE harness
11	179-0683-00			1	CABLE harness, chassis

(A)(D)

Rear Chassis

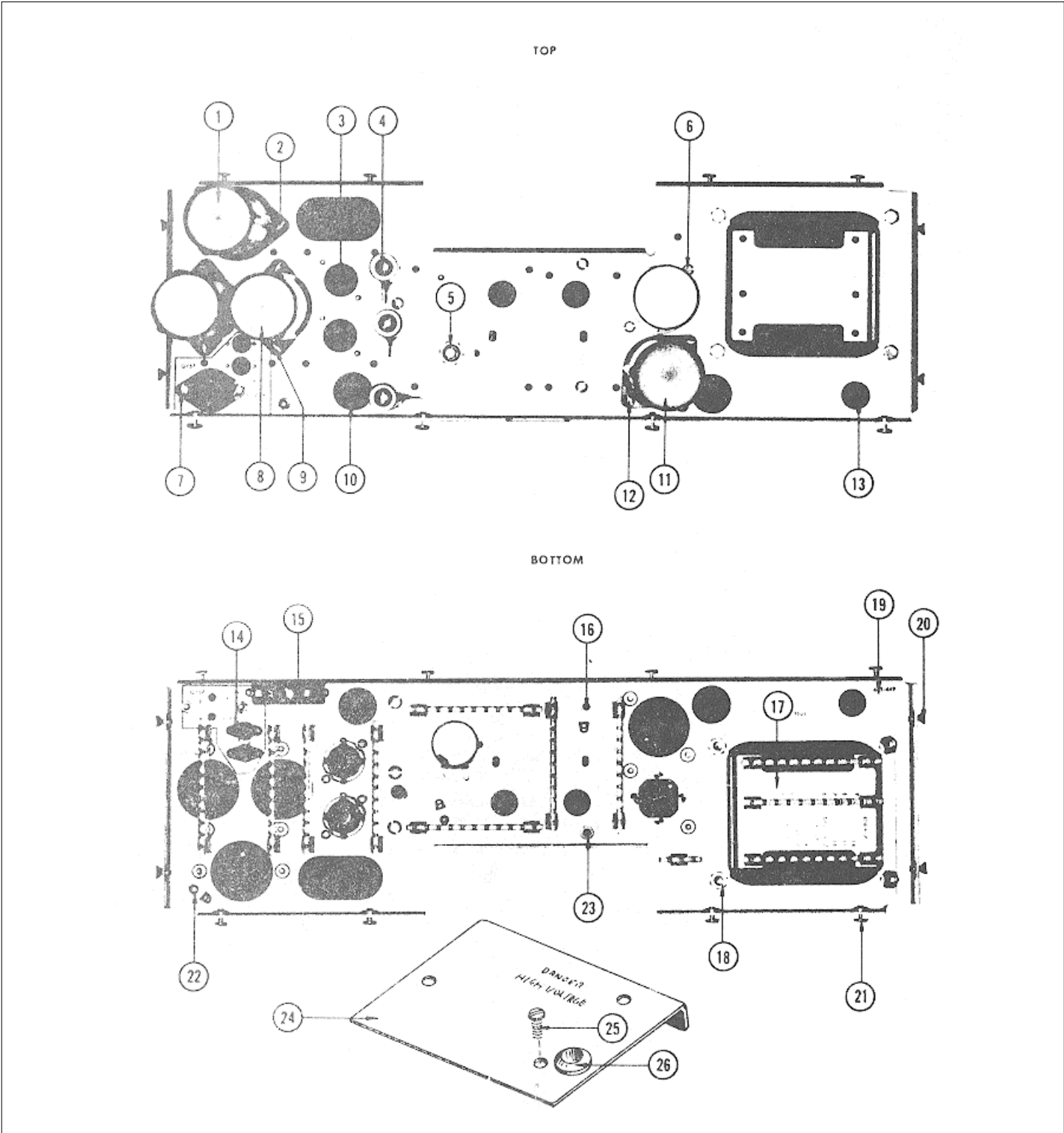

REAR CHASSIS

REF. NO.	PART NO.	SERIAL/MODEL NO.		QTY	DESCRIPTION
		EFF.	DISC.		
1	200-0258-00	5001	7799	1	COVER, capacitor, 3 1/32 inches
	200-0259-00	7800		1	COVER, capacitor, 3 9/16 inches
	386-0254-00			1	PLATE, fiber, large, capacitor mounting
	432-0044-00	X7800		1	BASE, capacitor mounting
	-----			-	Mounting Hardware: (not included)
2	211-0543-00	5001	7799	2	SCREW, 6-32 x 5/16 in. RHS
	211-0532-00	7800		2	SCREW, 6-32 x 3/16 inch Fil HS
3	136-0015-00			2	SOCKET, STM9G
				-	Mounting Hardware: (not included)
4	213-0044-00			2	SCREW, thread cutting, 5-32 x 3/16 in. Pan H phillips
	-----				Resistor Mounting Hardware:
	212-0037-00			3	SCREW, 8-32 x 1 3/4 in. Fil HS
	210-0808-00			3	WASHER, brass, centering resistor
	210-0462-00			3	NUT, hex, alum. 8-32 x 1/2 in.
5	212-0004-00			3	SCREW, 8-32 x 5/1 in. BHS
				-	Pot Mounting Hardware:
	210-0413-00			1	NUT, hex, brass, 3/8-32 x 1/2 in.
	210-0840-00			1	WASHER, steel
6	386-0255-00			1	PLATE, metal large, capacitor mounting
	-----			-	Mounting Hardware: (not included)
7	211-0534-00			2	SCREW, 6-32 x 5/16 in. PHS, with lockwasher
	-----			-	Transistor Mounting Hardware:
	211-0510-00			2	SCREW, 6-32 x 3/ in. BHS
	210-0006-00			1	LOCKWASHER, steel, internal #6
8	210-0407-00			2	NUT, hex, brass, 6-32 x 1/4 in.
	200-0293-00			2	COVER, capacitor, polyethylene
9	386-0254-00			2	PLATE, fiber, large, capacitor mounting
	211-0543-00			4	SCREW, (capacitor assembly) 6-32 x 5/16 in. RHS
10	348-0050-00			2	GROMMET, delrin, 3/4, in.
	200-0259-00			1	COVER, capacitor, polyethylene
11	432-0044-00			1	BASE, capacitor mounting
	386-0254-00			1	PLATE, fiber, large, capacitor mounting
	-----			-	Mounting Hardware: (not included)
12	211-0532-00			2	SCREW, 6-32 x 3/4 in. HS Fil
13	348-0005-00			5	GROMMET, rubber, 1/2 in.
14	136-0095-00	5001	6639	2	SOCKET, 4 pin, transistor
	136-0181-00	6640		2	SOCKET, 3 pin transistor
	-----			-	Mounting Hardware: (not included)
15	213-0113-00	5001	6639	2	SCREW, 2-32x 5/16 in. RHS, phillips, thread forming
	354-0234-00	6640		1	RING, locking, transistor socket
	352-0031-00		1	1	HOLDER, fuse, single, 3AG
				-	Mounting Hardware: (not included)
	211-0510-00			1	SCREW, 6-32x 3/8 in. BHS
	210-0006-00			1	LOCKWASHER, steel, internal #6
	210-0407-00			1	NUT, hex, brass, 6-32 x 1/4 in.

(A)(C)

REAR CHASSIS (Cont'd)

REF.	PART NO.	SERIAL/MODEL NO.		Q T	DESCRIPTION
16	166-0099-00 ----- 211-0507-00 210-0202-00			2 - 1	TUBE, spacer, alum. 1/4 x 1 23/32 in. Mounting Hardware: (not included) SCREW, 6-32 x 5/16 in. BHS
17	406-0617-00 406-0937-00	5001 6210	6209	1 1 - 1	LUG, solder, SE6 BRACKET, transformer strip mounting BRACKET, transformer mounting Mounting Hardware: (not included)
18	210-0564-00 210-0010-00			4 4	NUT, 10-32 x 3/8 in. LOCKWASHER, steel, internal #10
19	441-0449-00 441-0540-00 -----	5001 6210	6209	1 1 -	CHASSIS, rear CHASSIS, rear Mounting Hardware: (not included)
20	212-0070-00			4	SCREW, 8-32 x 5/16 in. FHS
21	212-0004-00			8	SCREW, 8-32 x 5/16, in. BHS
22	210-0201-00 213-0044-00			2 2	LUG. solder, SE4 SCREW, thread cutting, 5-32 x 3/16 in. Pan H
23	385-0060-00			2	ROD, nylon, 5/16 dia. x 1 3/4 in.
24	211-0507-00 337-0534-00 -----			2 1 -	SCREW, 6-32 x 5/16 in. BHS SHIELD, H.V. Power mounting hardware: (not included)
25	211-0507-00			3	SCREW, 6-32 x 5/16, in. BHS
26	348-0005-00 348-0063-00	5001 9060	9059	1 1	GROMMET, rubber, 1/2 in. GROMMET, plastic, 1/2 inch

(A)(C)

SWITCHES

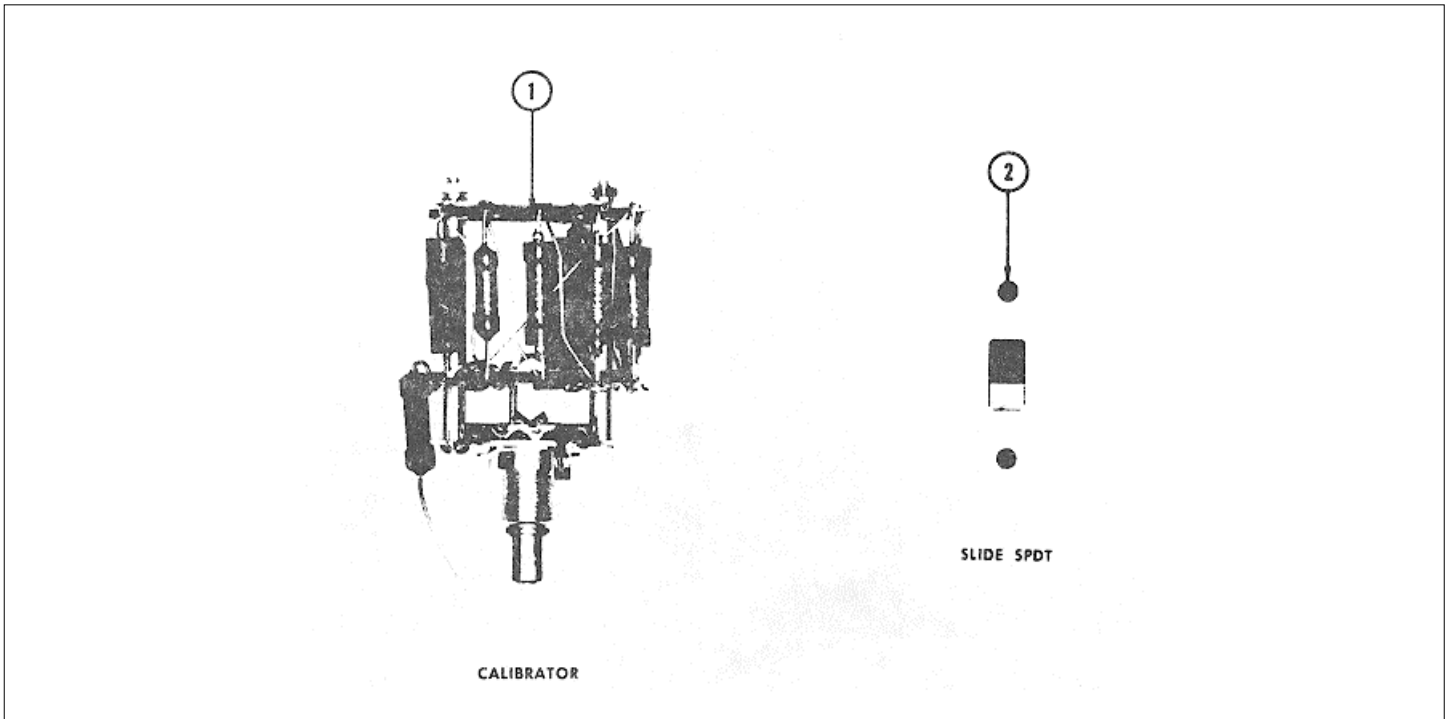

REF. NO.	PART NO.	SERIAL/MODEL NO.		QTY	DESCRIPTION
		EFF.	DISC.		
1	262-0515-00			1	SWITCH, Calibrator, wired
	260-0394-00			1	SWITCH, Calibrator, unwired
2	210-0413-00			1	Mounting Hardware: (not included)
	210-0840-00			1	NUT, hex, brass 3/8-32 x 1/2 in.
	210-0013-00			1	WASHER, steel
	260-0449-00			1	LOCKWASHER, steel, internal 3/8 x 11/16 in.
	211-0008-00			2	SWITCH, raw, slide, SPDT
	210-0406-00			2	Mounting Hardware: (not included)
				2	SCREW, 4-40 x 1/4 in. BHS
				2	NUT, hex, brass, 4-40 x 3/16 in.

(A)(C)

CRT SHIELD

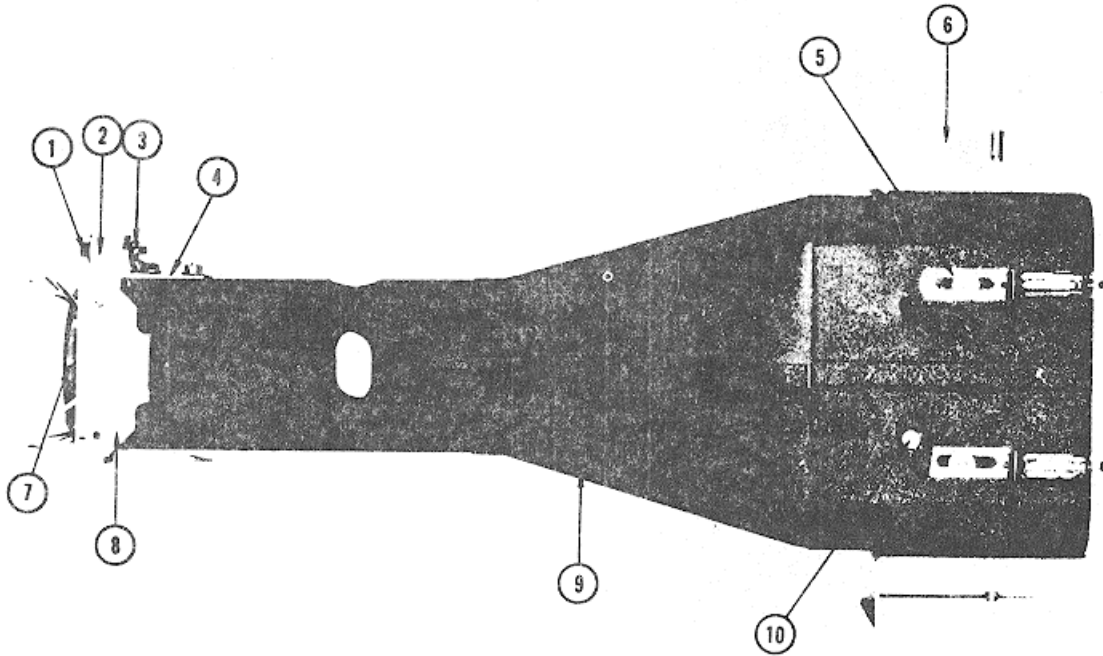

REF. NO.	PART NO.	SERIAL/MODEL NO.		QTY	DESCRIPTION
		EFF.	DISC.		
1	211-0576-00 210-0949-00			2	SCREW, 6-32 x 7/8 in. socket head cap, black finish
2	354-0147-00 354-0212-00	5001 5490	5489	2	WASHER, brass, 1/2 in.
	-----			1	RING, clamping, delrin, 1/2 x 2 1/4 in.
	124-0160-00	X5490		1	RING, clamping, delrin
	211-0560-00	5001	10529	-	ring includes:
	211-0529-00	10530		1	STRIP, liner
	210-0407-00	5001 6508		1	SCREW, 6-32 x 1 in. RHS
	220-0419-00	6509		1	SCREW, 6-32 x 1 1/4 inches, PHS
3	214-0207-00			1	NUT, hex, 6-32 x 1/4 inch
4	406-0730-00			1	NUT, 6-32 x 5/16 inch
	-----			1	NUT, adj. securing
	211-0534-00			1	BRACKET, parallax adj. zinc plated
	210-0803-00			-	Mounting Hardware: (not included)
	210-0006-00			4	SCREW, 6-32 x 5/16 in. PHS, with lockwasher
	210-0407-00			4	WASHER, steel, 6L x 3/6 in.
	124-0173-00	X10530		4	LOCKWASHER, steel, internal #6
				4	NUT, hex, brass, 6-32 x 1/4 in.
				1	STRIP, ground, CRT shield

(A)(B)

CRT SHIELD

REF. NO.	PART NO.	SERIAL/MODEL NO.		QTY	DESCRIPTION	
		EFF.	DISC.			
5	136-0035-00			2	SOCKET, graticule light, with ground lug Mounting Hardware: (not included)	
	211-0534-00			1	SCREW, 6-32 x 5/16 in. PHS, with lockwasher	
	210-0803-00			3	WASHER, steel, 6L x 3/8 in.	
	210-0006-00			1	LOCKWASHER, steel internal #6	
	210-0407-00			1	NUT, hex, brass, 6-32 x 1/4 in.	
6	406-0847-00			1	BRACKET, CRT Shield, left	
	406-0846-00			1	BRACKET, CRT Shield, right Mounting Hardware: (not included)	
	212-0004-00			2	SCREW, 8-32 x 5/16 in. BHS	
	212-0070-00			1	SCREW, 8-32 x 5/16 in, FHS	
	210-0458400			3	NUT, keps, steel, 8-3 x 11/32 in.	
	211-0534-00			2	SCREW, 6-32 x 5/16 in. PHS, with lockwasher	
	210-0006-00			2	LOCKWASHER, steel, internal #6	
	210-0407-00			2	NUT, hex, brass, 6-32 x 1/4 in.	
	7	136-0136-00	5001	5729	1	SOCKET, CRT assembly
		136-0177-00	5730		1	SOCKET, CRT assembly Consisting of:
131-0178-00				9	CONNECTOR, cable end	
136-4117-00				1	SOCKET, CRT 14 pin	
210-0849-00				2	WASHER, fiber #4, shoulder	
210-0850-00				2	WASHER, steel, #2, flat	
213-0116-00				2	SCREW, thread, cutting, #2 x 9/16 in., steel	
337-0456-00				1	SHIELD, CRT socket	
387-0393-00				1	PLATE, back, CRT socket	
8		406-0867-00	5001	12819	1	BRACKET, CRT mounting
	406-0867-01	12820		1	BRACKET, CRT mounting Mounting Hardware: (not included)	
	211-0504-00			1	SCREW, 6-32 x 1/4 in. BHS	
	211-0507-00	5001	12819	2	WASHER, steel, 6L x 3/8 in.	
	211-0507-00	12820		3	SCREW, 6-32 x 5/16 in. BHS	
	210-0803-00	5001	12819	2	SCREW, 6-32 x 5/16 in. BHS	
	210-0803-00	12820		3	WASHER, steel, 6L x 3/8 in.	
	210-0006-00	X12820		1	LOCKWASHER, steel, internal #6	
	210-0407-00	X12820		1	NUT, hex, brass, 6-32 x 1/4 in.	
	9	337-0530-00			1	SHIELD, CRT
337-0692-00		X10530	11969	1	SHIELD, CRT extension sleeve	
337-0692-01		11970		1	SHIELD, CRT extension sleeve	
162-0592-00		X12535		1	INSULATION, sheet	
10	352-0044-00			1	HOLDER, form coil, CRT polypropylene, black	
	211-0011-00	5001	7909	1	SCREW, 4-40 x 5/16 in. BHS	
	211-0110-00	7910		1	SCREW, 4-40x 5/16 inch PHB	
	210-0004-00			1	LOCKWASHER, steel, internal #4	
	210-0406-00			1	NUT, hex, brass, 4-40 x 3/16 in.	

(A)(J)

STANDARD ACCESSORIES

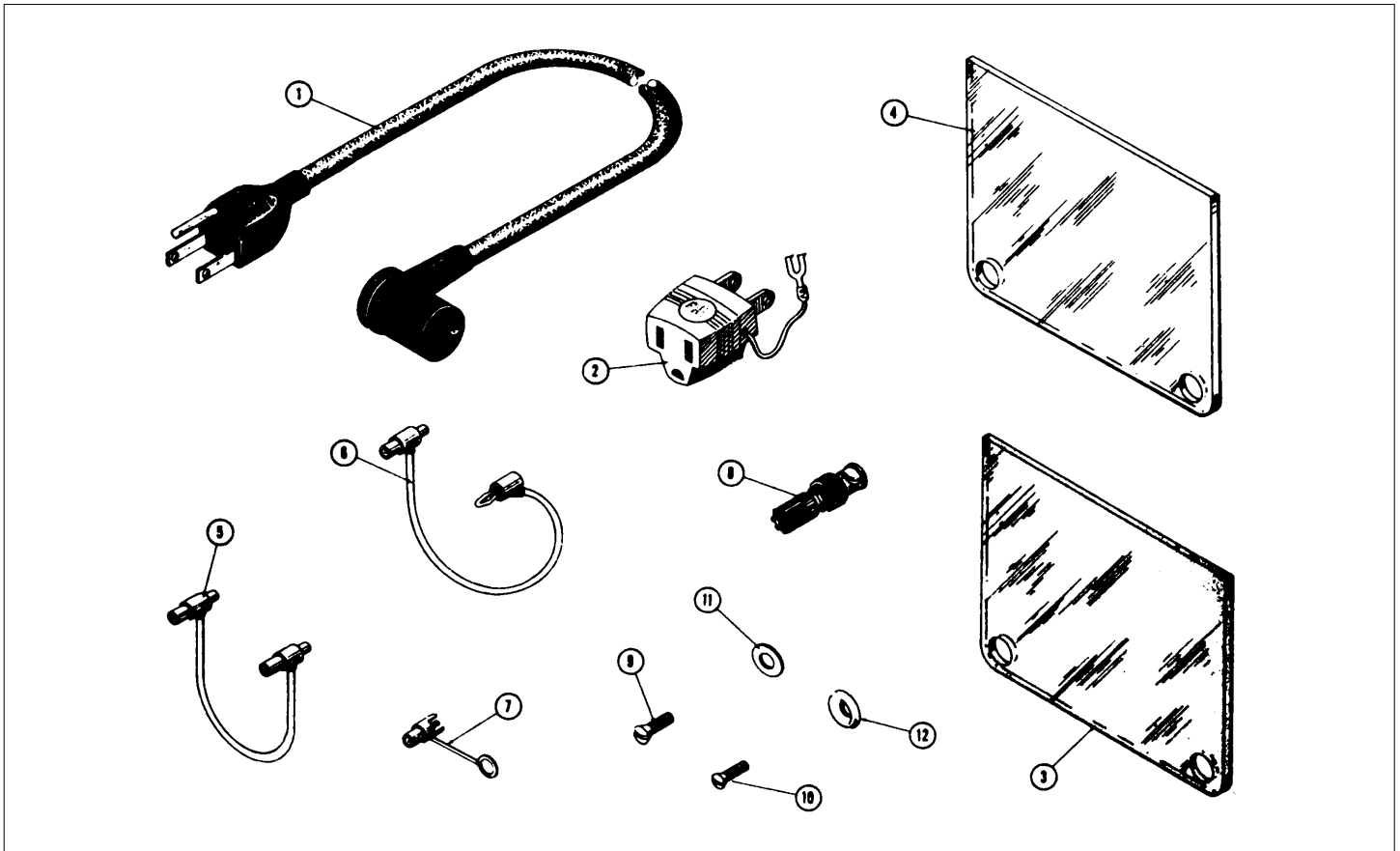

REF. NO.	PART NO.	SERIAL/MODEL NO.		QTY	DESCRIPTION
		EFF.	DISC.		
1	161-0013-00	5001	7499	1	CORD, power
	161-0022-00-	7500	8829	1	CORD, power
	161-0024-00	8830	9819	1	CORD, power
	161-0024-00	8830	11589	1	CORD, power
	161-0024-01	11590		1	CORD, power
2	103-0013-00			1	ADAPTER, 3 to 2-wire
3	378-0534-00	5001	6885	1	FILTER, green
	378-0544-00	6886	8607	1	FILTER, smoke gray (installed)
	378-0560-00	8608		1	FILTER, smoke gray (installed)
4	387-0935-00	X6886		1	PLATE, protector
5	012-0031-00	X6200	7978	1	CORD, patch
	012-0087400	7979		1	CORD, patch
6	01 2-091-00	X7979		1	CORD, patch
7	012-0092-00	X7979		1	JACK, BNC-post
8	103-0033-00	X5280	X7978X	2	ADAPTER, BNC to binding post
9	212-0512-00			4	SCREW, 10-32 x 1/2 OHS
10	212-0561-00			4	SCREW, 12-24 x 1/2 OHS
11	210-0833-00			4	WASHER, teflon
12	210-0917-00			4	WASHER, steel, finishing #10
--	070-0352-01			2	MANUAL, instruction (not shown)

(A)(F)

TYPE R561B

FIG. 1 FRONT

Fig. & Index No.	Tektronix Part No.	Serial/Model No.		Q t y	1 2 3 4 5	Description
		Eff	Disc			
1-1	200-0426-00			1		COVER, graticule
	-----			-		mounting hardware: (not included w/cover)
-2	210-0571-00			4		NUT, knurled
-3	352-0144-00			2		HOLDER, light conductor
-4	386-1440-00			1		LIGHT CONDUCTOR
-5	378-0560-00			1		FILTER, light, smoke gray
-6	354-0181-00			1		RING, CRT shock-mount
-7	337-0539-00			1		SHIELD, implosion
-8	366-0236-00			1		KNOB, gray-SCALE ILLUM
	-----			-		knob includes:
	213-0020-00			1		SCREW, set, 6-32 x 1/8 inch, HSS
-9	-----			1		RESISTOR, variable
	-----			-		mounting hardware: (not included w/resistor)
	210-0978-00			1		WASHER, flat, 3/8 x 1/2 inch
-10	210-0590-00			1		NUT, hex., 3/8-32 x 7/16 inch
-11	366-0322-01			1		KNOB, gray-CALIBRATOR
	-----			-		knob includes:
	213-0004-00			1		SCREW, set, 6-32 x 3/16 inch, HSS
-12	262-0839-00			1		SWITCH, wired-CALIBRATOR
	-----			-		switch includes:
	260-0999-00			1		SWITCH, unwired
	-----			-		mounting hardware: (not included w/switch)
	210-0012-00			1		LOCKWASHER, internal, 3/8 ID x 1/2 inch OD
-13	210-0590-00			1		NUT, hex., 3/8-32 x 7/16 inch
-14	366-0153-00			1		KNOB, gray-FOCUS
	-----			1		knob includes:
	213-0004-00			1		SCREW, set, 6-32 x 3/16 inch, HSS
-15	-----			1		RESISTOR, variable
	-----			-		mounting hardware: (not included w/resistor)
	210-0046-00			1		LOCKWASHER, internal, 1/4 ID x 0.400 inch OD
	210-0940-00			1		WASHER, flat, 1/4 ID x 3/8 inch OD
	210-0583-00			1		NUT, hex., 1/4-32 x 5/16 inch

(A)

FIG. 1 FRONT (Cont)

Fig. & Index No.	Tektronix Part No.	Serial/Model No.		Qty	Description
		Eff	Disc		
1-16	366-0236-00			1	KNOB, gray-INTENSITY
	-----			-	knob includes:
	213-0020-00			1	SCREW, set, 6-32 x 1/8 inch, HSS
-17	-----			1	RESISTOR, variable
				-	mounting hardware: (not included w/resistor)
	210-0012-00			1	LOCKWASHER, internal, 3/8 ID x 1/2 inch OD
	210-0978-00			1	WASHER, flat, 3/8 x 1/2 inch
	210-0590-00			1	NUT, hex., 3/8-32 x 7/16, inch
	210-0207-00			1	LUG, solder, 3/8 ID x 3/8 inch OD, SE
-18	-----			2	RESISTOR, variable
	-----			-	mounting hardware for each: (not included w/resistor)
	210-0013-00			2	LOCKWASHER, internal, 3/8 ID x 11/16 inch OD
-19	210-0494-00			1	NUT, hex., 3/8-32 1/2 x 11/16 inch OD
-20	358-0010-00			1	BUSHING, hex., 1/2 inch long
-21	131-0274-00			1	CONNECTOR, coaxial, 1 contact, BNC, w/hardware
-22	136-0223-00			1	SOCKET, light, w/green lens
	-----			-	mounting hardware: (not included w/socket)
-23	210-0223-00			1	LUG, solder, 1/4 ID x 7/16, inch OD, SE
	210-0940-00			1	WASHER, flat, 1/4 ID x 3/8 inch OD
-24	210-0562-00			1	NUT, hex., 1/4-40 x 5/16 inch
-25	200-0608-00			1	COVER, variable resistor
-26	136-0264-00			3	SOCKET, graticule light
	-----			-	mounting hardware for each: (not included w/socket)
-27	211-0590-00			1	SCREW, 6-32 x 1/4 inch, non-magnetic, PHS
	210-0457-00			1	NUT, keps, 6-32 x 5/16, inch
-28	348-0056-00			3	GROMMET, plastic, 3/8 inch
-29	333-1081-01			1	PANEL, front
-30	367-0032-00			2	HANDLE
				-	mounting hardware for each: (not included w/handle)
-31	212-0557-00			2	SCREW, 10-32 x 1/2 inch, RHS
-32	386-1426-00			1	PLATE, sub-panel, front
				-	plate includes:
-33	355-0066-00			4	STUD, graticule
-34	407-0466-00			1	BRACKET
	-----			-	mounting hardware: (not included w/bracket)
-35	212-0070-00			1	SCREW, 8-32 x 5/16 inch, 100°csk, FHS
	212-4004-00			2	SCREW, 8-32 x 5/16 inch, PHS
	210-0458-00			2	NUT, keps, 8-32 x 11/32 inch

(B)

FIG. 1 FRONT (Cont)

Fig. & Index No.	Tektronix Part No.	Serial/Model No.		Q t y	1 2 3 4 5	Description
		Eff	Disc			
1-36	337-1027-00			1		SHIELD
	-----			-		mounting hardware: (not included w/shield)
-37	211-0504-00			3		SCREW, 6-32 x 1/4 inch, PHS
	210-0803 00			2		WASHER, flat, 0.150 ID x 3/8 inch OD
-38	407-0473-00			1		BRACKET
	-----			-		mounting hardware: (not included w/bracket)
-39	212-0070-00			1		SCREW, 8-32 x 5/16, inch, 100° csk, FHS
	212-0004-00			2		SCREW, 8-32 x 5/16 inch, PHS
	210-0458-00			2		NUT, keps, 8-32 x 1/32 inch
-40	337-1032-00			1		SHIELD
	-----			-		mounting hardware: (not included w/shield)
-41	211-0504-00			3		SCREW, 6-32 x 1/4 inch, PHS
-42	210-0803.00			2		WASHER, flat, 0.150 ID x 3/8 inch OD
-43	337-1021-01			1		SHIELD, CRT
	-----			-		mounting hardware: (not included w/shield)
-44	211-0590-00			4		SCREW, 6-32 x 1/4 inch, PHS, non-magnetic
	210-0457-00			4		NUT, keps, 6-32 x 5/16 inch
-45	-----			1		COIL
	-----			-		mounting hardware: (not included w/coil)
-46	352-0044-00			1		HOLDER, coil
	211-0148-00			1		SCREW, 4-40 x 5/16, inch, PHS, non-magnetic
	210-0586-00			1		NUT, keps, 4-40 x 1/4 inch
-47	343-0138-00			1		CLAMP, CRT retainer, black
-48	343-0171-01			1		CLAMP, CRT retainer, tapped
-49	343-0123-01			1		CLAMP, CRT retainer
-50	211-0146-00			1		SCREW, 4-40 x 1.312 inches Filister HS
-51	352-0123-01			2		CLAMP, retainer, CRT holder
-52	211-0590-00			4		SCREW, 6-32 x 1/4 inch, PHS, non-magnetic
-53	211-0599-00			2		SCREW, 6-32 x 3/4 inch Filister HS
-54	220-0444-00			2		NUT, square, 6-32 x 1/4 inch
-55	348-0085-00			1		BUSHING, U-shaped
-56	175-0641-00			1		CRT LEAD, brown
	175-0642-00			1		CRT LEAD, blue
	175-0705-00			1		CRT LEAD, green
	175-0706-00			1		CRT LEAD, red

(A)

FIG. 1 FRONT (Cont)

Fig. & Index No.	Tektronix Part No.	Serial/Model No.		Qty	1 2 3 4 5	Description
		Eff	Disc			
1-57	406-0716-00 -----			2		BRACKET, plug-in mounting hardware for each: (not included w/bracket)
-58	211-0538-00			2		SCREW, 6-32 x 5/16 inch, 100° csk, FHS
-59	210-0457-00			2		NUT, keps, 6-32 x 5/16 inch
	212-0004-00			2		SCREW, 8-32 x 5/16 inch
	210-0458-00			2		NUT, keps, 8-32 x 11/32 inch
-60	351-0047-00 -----			2		GUIDE, plug-in mounting hardware for each: (not included w/guide)
-61	211-0541-00			2		SCREW, 6-32 x 1/4 inch, 100° csk, FHS
	210-0407-00			1		NUT, hex., 6-32 x 1/4 inch
-62	387-0449-00 -----			1		PLATE, right side cover mounting hardware: (not included w/plate)
-63	211-0504-00			4		SCREW, 6-32 x 1/4 inch, PHS
-64	211-0541-00			2		SCREW, 6-32 x 1/4 inch, 100° csk, FHS
-65	390-0048-00 -----			1		CABINET SIDE, right mounting hardware: (not included w/cabinet side)
66	212-0070-00			8		SCREW, 8-32 x 5/16 inch, 100° csk, FHS
	210-0458-00			6		NUT, keps, 8-32 x 11/32 inch
-67	387-0450-00 -----			1		PLATE, left side cover mounting hardware: (not included w/plate)
-68	211-0504-00			4		SCREW, 6-32 x 1/4 inch, PHS
-69	211-0541-00			2		SCREW, 6-32 x 1/4 inch, 100° csk, FHS
-70	390-0047-00 -----			1		CABINET SIDE, left mounting hardware: (not included w/cabinet side)
-71	212-0070-00			6		SCREW, 8-32 x 5/16, inch, 100° csk, FHS
-72	210-0458-00			6		NUT, keps, 8-32 x 11/32 inch
-73	387-0452-00 -----			2		PLATE, dust cover mounting hardware for each: (not included w/cabinet)
-74	211-0504-00			9		SCREW, 6-32 x 1/4 inch, PHS
-75	214-0335-00 -----			1		BOLT, current loop mounting hardware: (not included w/bolt)
-76	361-0059-00			1		SPACER, current loop
	210-0004-00			1		LOCKWASHER, internal, #4
	210-0201-00			1		LUG, solder, SE #4
	210-0442-00			2		NUT, hex., 3-48 x 3/16, inch
	210-0849-00			1		WASHER, fiber, #4
	210-0593-00			2		NUT, current loop

(A)

FIG. 2 REAR

Fig. & Index No.	Tektronix Part No.	Serial/Model No.		Q t y	1 2 3 4 5	Description
		Eff	Disc			
2-1	441-0801-00			1		CHASSIS, storage
	-----			-		mounting hardware: (not included w/chassis)
-2	212-0002-00			2		SCREW, 8-32 x 1/4 inch, 100° csk, FHS
-3	212-0004-00			2		SCREW, 8-32 x 5/16 inch, PHS
	210-0458-00			4		NUT, keps, 8-32 x 3/8 inch
	211-0510-00			2		SCREW, 6-32 x 5/16, inch, PHS
-4	210-0457-00			2		NUT, keps, 6-32 x 5/16, inch
	212-0070-00			2		SCREW, 8-32 x 5/16, inch, 100° csk, FHS
	212-0001-00			2		SCREW, 8-32 x 1/4 inch, PHS
-5	441-0792-00			1		CHASSIS, power supply
	-----			-		mounting hardware: (not included w/chassis)
-6	212-0004-00			6		SCREW, 8-32 x 5/16 inch, PHS
-7	386-1444-00			1		PANEL, rear
	-----			-		mounting hardware: (not included w/panel)
-8	212-0004-00			4		SCREW, 8-32 x 5/16, inch, PHS
	210-0458-00			4		NUT, keps, 8-32 x 11/32 inch
-9	344-0095-00			2		CLIP, ground
	-----			-		mounting hardware for each: (not included w/clip)
-10	210-0457-00			1		NUT, keps, 6-32 x 5/16, inch
-11	211-0541-00			1		SCREW, 6-32 x 1/4 inch, 100° csk, FHS
-12	-----			-		RESISTOR, variable
	-----			-		mounting hardware: (not included w/resistor)
-13	210-0012-00			1		LOCKWASHER, internal, 3/8 ID x 1/2 inch OD
-14	210-0987-00			1		WASHER, flat, 3/8 ID x 1/2 inch OD
-15	210-0590-00			1		NUT, hex., 3/8-32 x 1/2 inch
-16	-----			4		CAPACITOR
	-----			-		mounting hardware for each: (not included w/capacitor)
-17	432-0048-00			1		BASE, capacitor mounting
-18	386-0254-00			1		PLATE, fiber, large
-19	211-0516-00			2		SCREW, 6-32 x 3/4 inch, PHS
-20	210-0457-00			2		NUT, keps, 6-32 x 5/16, inch
-21	200-0259-00			3		COVER, capacitor, plastic, 1.365 ID x 3-9/16 inches long
-22	-----			1		CAPACITOR
	-----			-		mounting hardware: (not included w/capacitor)
-23	386-0253-00			1		PLATE, metal, small
-24	211-0534-00			2		SCREW, sems, 6-32 x 5/16, inch, PHS
	210-0457-00			2		NUT, keps, 6-32 x 5/16 inch

(A)

FIG. 2 REAR (Cont)

Fig. & Index No.	Tektronix Part No.	Serial/Model No.		Qty	1 2 3 4 5	Description
		Eff	Disc			
2-25	179-1336-00	B010100	B049999	1		CABLE HARNESS, power
	179-1336-01	B050000	B059999	1		CABLE HARNESS, power
	179-1336-02	B060000	B089999	1		CABLE HARNESS, power
	179-1336-03	B090000		1		CABLE HARNESS, power
	-----			-		cable harness includes:
-26	131-0371-00			37		CONNECTOR, single contact, female
-27	351-0158-00			2		GUIDE, shaft
	-----			-		mounting hardware for each: (not included w/guide)
	361-0009-00			1		SPACER, nylon
-28	385-0138-00			2		ROD, plastic
	-----			-		mounting hardware for each: (not included w/rod)
-29	213-0041-00			1		SCREW, thread cutting, 6-32 x 3/8 inch, THS
-30	385-0075-00			3		ROD, plastic
	-----			-		mounting hardware for each: (not included w/rod)
-31	211-0507-00			1		SCREW, 6-32 x 5/16 inch, PHS
-32	131-01 48-00			2		CONNECTOR, 24 pin
	-----			-		mounting hardware for each: (not included w/connector)
-33	211-0016-00			2		SCREW, 4-40 x 5/8 inch, PHS
-34	166-0030-00			2		TUBE, spacer, 0.180 ID x 3/16, inch long
-35	210-0586-00			2		NUT, keps, 4-40 x 1/4 inch
-36	252-0564-00			IN.		CHANNEL, plastic, 10-1/2 inches
-37	-----			1		THERMAL CUTOUT
	-----			-		mounting hardware: (not included w/thermal cutout)
-38	211-0541-00	B010100	B020269	2		SCREW, 6-32 x 1/4 inch, 100° csk, FHS
	210-0006-00	B010100	B020269	2		LOCKWASHER, internal, #6
	210-0407-00	B010100	B020269	2		NUT, hex., 6-32 x 1/4 inch
	210-0586-00	B020270		2		NUT, keps, 4-40 x 1/4 inch
-39	670-0610-00			1		ASSEMBLY, circuit board-POWER SUPPLY
	-----			-		assembly includes:
	388-1031-00			1		BOARD, circuit
-40	131-0633-00			47		TERMINAL PIN
41	136-0183-00			7		SOCKET, transistor
-42	136-0220-00			9		SOCKET-, transistor
-43	136-0235-00			4		SOCKET, semi-conductor device
-44	343-0043-00			1		CLAMP, neon bulb
-45	344-0154-00			2		HOLDER, fuse
	-----			-		mounting hardware: (not included w/assembly)
-46	211-0601-00			4		SCREW, sems, 6-32 x 5/16, inch, PHB

(D)

FIG. 2 REAR (Cont)

Fig. & Index No.	Tektronix Part No.	Serial/Model No.		Q t y	1 2 3 4 5	Description
		Eff	Disc			
2-47	385-0168-00			2		ROD, spacer, 1/4 inch, hex., x 1.168 inches long
	-----			-		mounting hardware for each: (not included w/rod)
-48	210-0006-00			1		LOCKWASHER, internal, #6
	211-0541-00			1		SCREW, 6-32 x 1/4 inch, 100° csk, FHS
-49	385-0146-00			2		ROD, spacer, 1/4 inch, hex., x 0.700 inch long
	-----			-		mounting hardware for each: (not included w/rod)
	210-0006-00			1		LOCKWASHER, internal, #6
	211-0507-00			1		SCREW, 6-32 x 5/16, inch PHS
-50	-----			1		RESISTOR, variable
	-----			-		mounting hardware: (not included w/resistor)
-51	210-0940-00			1		WASHER, flat, 1/4 ID x 3/8 inch OD
	210-0046-00			1		LOCKWASHER, internal, 1/4 ID x 0.400 inch OD
	210-0583-00			1		NUT, hex., 1/4-32 x 5/16 inch
-52	-----					TRANSISTOR
	-----			-		mounting hardware: (not included w/transistor)
-53	213-0183-00			2		SCREW, thread forming, 6-32 x 1/2 inch, PHS
-54	-----			2		TRANSISTOR
	-----			-		mounting hardware for each: (not included w/transistor)
-55	213-0183-00			2		SCREW, thread forming, 6-32 x 1/2 inch, PHS
-56	386-0143-00			1		PLATE, mica insulator
-57	-----			2		TRANSISTOR
	-----			-		mounting hardware for each: (not included w/transistor)
-58	213-0183-00			2		SCREW, thread forming, 6-32 x 1/1 inch, PHS
-59	386-0978-00			1		PLATE, mica insulator
-60	136-0280-00			3		SOCKET, transistor
	-----			-		mounting hardware for each: (not included w/socket)
-61	213-0088-00			2		SCREW, thread forming, 4-40 x 1/4 inch, PHS
-62	136-0270-00			2		SOCKET, transistor
	-----			-		mounting hardware for each: (not included w/socket)
-63	213-0088-00			2		SCREW, thread forming, 4-40 x 1/4 inch, PHS
-64	200-0608-00			1		COVER, plastic, variable resistor
-65	-----			1		RESISTOR
	-----			-		mounting hardware: (not included w/resistor)
-66	211-0553-00			1		SCREW, 6-32 x 1-1/2 inches, RHS
-67	210-0601.00			1		EYELET
-68	210-0478-00			1		NUT, hex., 1/4 x 21/32 inch long
-69	211-0507-00			1		SCREW, 6-32 x 5/16 inch, PHS

(A)

FIG. 2 REAR (Cont)

Fig. & Index No.	Tektronix Part No.	Serial/Model No.		Qty	1 2 3 4 5	Description
		Eff	Disc			
2-70	210-0204-00			2		LUG, solder, DE #6
	-----			-		mounting hardware for each: (not included w/lug)
-71	211-0541-00			1		SCREW, 6-32 x 1/4 inch, 100° csk, FHS
	210-0407-00			1		NUT, hex., 6-32 x 1/4 inch
-72	200-0900-00					COVER, transformer terminals
-73	-----			-		TRANSFORMER
	-----			-		transformer includes:
-74	212-0522-00			4		SCREW, 10-32 x 2-1/2 inches, HHS
-75	210-0812-00			4		WASHER, fiber, #10
	-----			-		mounting hardware (not included w/transformer)
-76	220-0410-00			4		NUT, keps, 10-32 x 3/8 inch
-77	131-0126-00			1		CONNECTOR, coaxial, 1 contact, BNC, w/hardware
	-----			-		mounting hardware: (not included w/connector)
	210-0241-00			1		LUG, solder, 0.515 ID x 0.625 OD
-78	134-0067-00			9		PLUG, plastic, gray
-79	119-0031-00			1		ASSEMBLY, blower
-80	351-0046-00			2		GUIDE, clip, fan
	-----			-		mounting hardware: (not included w/guide)
-81	211-0541-00			4		SCREW, 632 x 1/4, inch, 100° csk, FHS
-82	210-0457-00			4		NUT, keps, 6-32 x 5/16, inch
-83	378-0761-00			1		SCREEN, grille
-84	200-0762-00			1		COVER, line voltage selector
	-----			-		cover includes:
-85	352-0102-00			2		HOLDER, fuse
	-----			-		mounting hardware for each: (not included w/holder)
	213-0035-00			2		SCREW, thread cutting, 4-40 x 1/4 inch, PHS
-86	204-0279-00			1		ASSEMBLY, line voltage selector
	-----			-		mounting hardware: (not included w/assembly)
-87	210-0407-00			2		NUT, hex., 6-32 x 1/4 inch
	210-0006-00			2		LOCKWASHER, internal #6
-88	358-0161-00			1		BUSHING, strain relief
-89	161-0046-00	B010100	B060919	1		CORD, power, 3 conductor
	161-0046-01	B060920		1		CORD, power, 3 conductor
-90	384-0439-00			1		ROD, extension, w/knob
-91	376-0053-00			1		COUPLING, rod
	-----			-		coupling includes:
	213-0048-00			2		SCREW, sit, 4-40 x 1/8 inch, HHS

(B)

FIG. 2 REAR (Cont)

Fig. & Index No.	Tektronix Part No.	Serial/Model No.		Q t y	1 2 3 4 5	Description
		Eff	Disc			
2-92	384-0702-00			1		ROD extension, 1/8, OD x 2-1/2 inches long
-93	260-0276-00			1		SWITCH, toggle-POWER
	-----			-		mounting hardware: (not included w/switch)
-94	354-0055-00			1		RING, locking switch
-95	210-0473-00			1		NUT, switch, 12 sided
-96	354-0285-00			1		RING, locking
-97	407-0467 00			1		BRACKET, toggle switch
	-----			-		mounting hardware: (not included w/bracket)
-98	211-0504-00			2		SCREW 6-32 x 1/4 inch, PHS
-99	406-0949-00			1		BRACKET
	-----			-		mounting hardware: (not included w/bracket)
-100	210-0586-00			2		NUT, keps, 4-40 x 1/4 inch
-101	103-0056-00			1		ADAPTER, switch actuator
-102	129-0072-00			1		POST
	-----			-		mounting hardware; (not included w/post)
-103	361-0007-00			1		SPACER, nylon
-104	200-0176-00			1		COVER, clip
	621-0435-00	B010100	B149999	1		ASSEMBLY, high voltage
	621-0435-01	B150000		1		ASSEMBLY, high voltage
	-----			-		assembly includes:
-105	136-0307-00	B010100	B0609999	1		ASSEMBLY, CRT socket
	136-0307-01	B070000		1		ASSEMBLY, CRT socket
	-----			-		assembly includes:
	136-0304-00			1		SOCKET, CRT
-106	131-0371-00			7		CONNECTOR, single contact, female
-107	200-0714-00			1		COVER, high voltage box
	-----			-		mounting hardware: (not included w/cover)
-108	211-0529-00			2		SCREW, 6-32 x 1-1/8, inches, PHS
-109	211-0510-00			1		SCREW, 6-32 x 3/8 inch, PHS
-110	670-0607-00			1		ASSEMBLY, circuit board (lower)
	-----			-		assembly includes:
	388-1030-00			1		BOARD, circuit
	-----			-		mounting hardware: (not included w/board)
-111	211-0040-00			4		SCREW, 4-40 x 1/4 inch, BH plastic
-112	670-0609-00			1		ASSEMBLY, circuit board (upper)
	-----			-		assembly includes:
	388-1029-00			1		BOARD, circuit
	-----			-		mounting hardware: (not included w/board)
-113	211-0040-00			4		SCREW 4-40 x 1/4 inch. BH plastic
-114	361-0137-00			4		SPACER

(C)

FIG. 2 REAR (Cont)

Fig. & Index No.	Tektronix Part No.	Serial/Model No.		Qty	1 2 3 4 5	Description
		Eff	Disc			
2-115	214-0931-00	B010100	B029999X	2		RETAINER, component
	346-0032-00	B010100	B029999X	1		STRAP, mousetail, rubber
-116	166-0319-00			4		SPACER, plastic
-117	380-0115-00			1		HOUSING
	-----			-		mounting hardware: (not include w/assembly)
	211-0507-00			3		SCREW, 6-32 x 5/16, inch, PHS
-118	337-0889-00			1		SHIELD, high voltage
	-----			-		mounting hardware: (not included w/shield)
	210-4570-00			2		NUT, keps, 6-32 x 5/16 inch
-119	337-0971-00			1		SHIELD, high voltage
	-----			-		mounting hardware (not included w/shield)
-120	211-0504-00			2		SCREW, 6-32 x 1/4 inch, PHS
-121	200-0917-00	B010100	B069999	1		COVER, CRT socket
	200-0917-01	B070000		1		COVER, CRT socket
-122	337-1046-01	B010100	B069999	1		SHIELD, CRT socket
	337-1199-01	B070000		1		SHIELD, CRT socket
-123	367-0095-00	B010100	B069999	1		HANDLE, CRT socket
	367-0117-00	B070000		1		HANDLE, CRT socket
-124	260 0450-00			1		SWITCH, side
	-----			-		mounting hardware: (not included w/shield)
-125	210-0406-00			2		NUT, hex, 4-40 x 3/16 inch
-126	348-0055-00			1		GROMMET, plastic, 1.4 inch
-127	348-0056-00			1		GROMMET, plastic, 3/8 inch
-128	348-0063-00			3		GROMMET, plastic, 1/2 inch
-129	348-0064-00			2		GROMMET, plastic, 5/8 inch
-130	343-0042-00			4		CLAMP, cable, 5/16 inch (1/2 clamp)
	-----			-		mounting hardware for each: (not included w/clamp)
-131	210-0457-00			1		NUT, 6-32 x 5/16 inch
	210-0863-00			1		WASHER, D-shaped
	211-0507-00			1		SCREW, 6-32 x 5/16 inch, PHS
-132	179-1328-00			-		CABLE HARNESS, line voltage selector
	-----			-		cable harness includes:.
-133	214-0768-00			8		CONTACT, electrical, female
-134	386-1422-00			-		SUPPORT, chassis shield

(?)

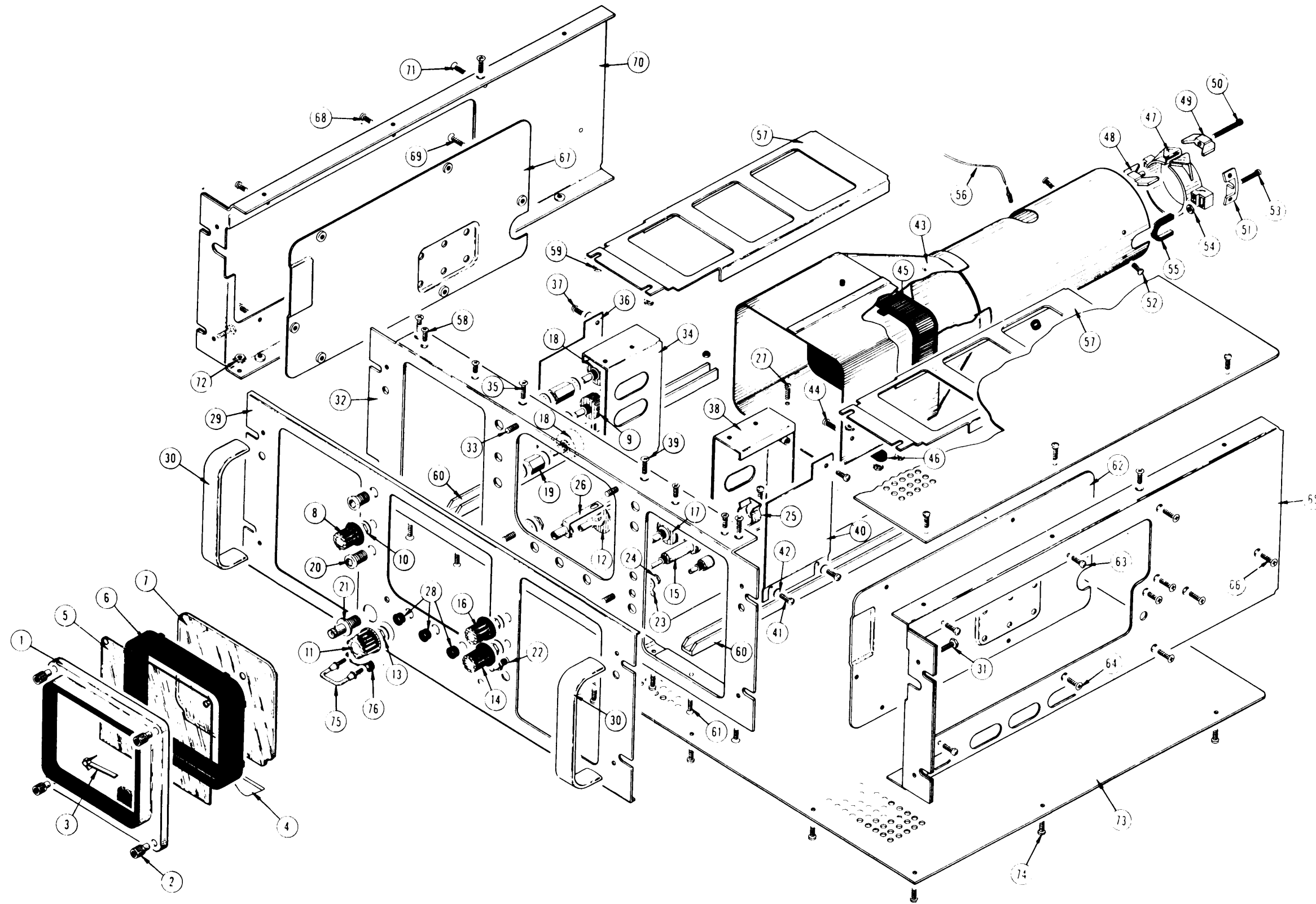

FIG. 1 FRONT



THIS PAGE CURRENTLY NOT AVAILABLE FOR DIGITIZATION

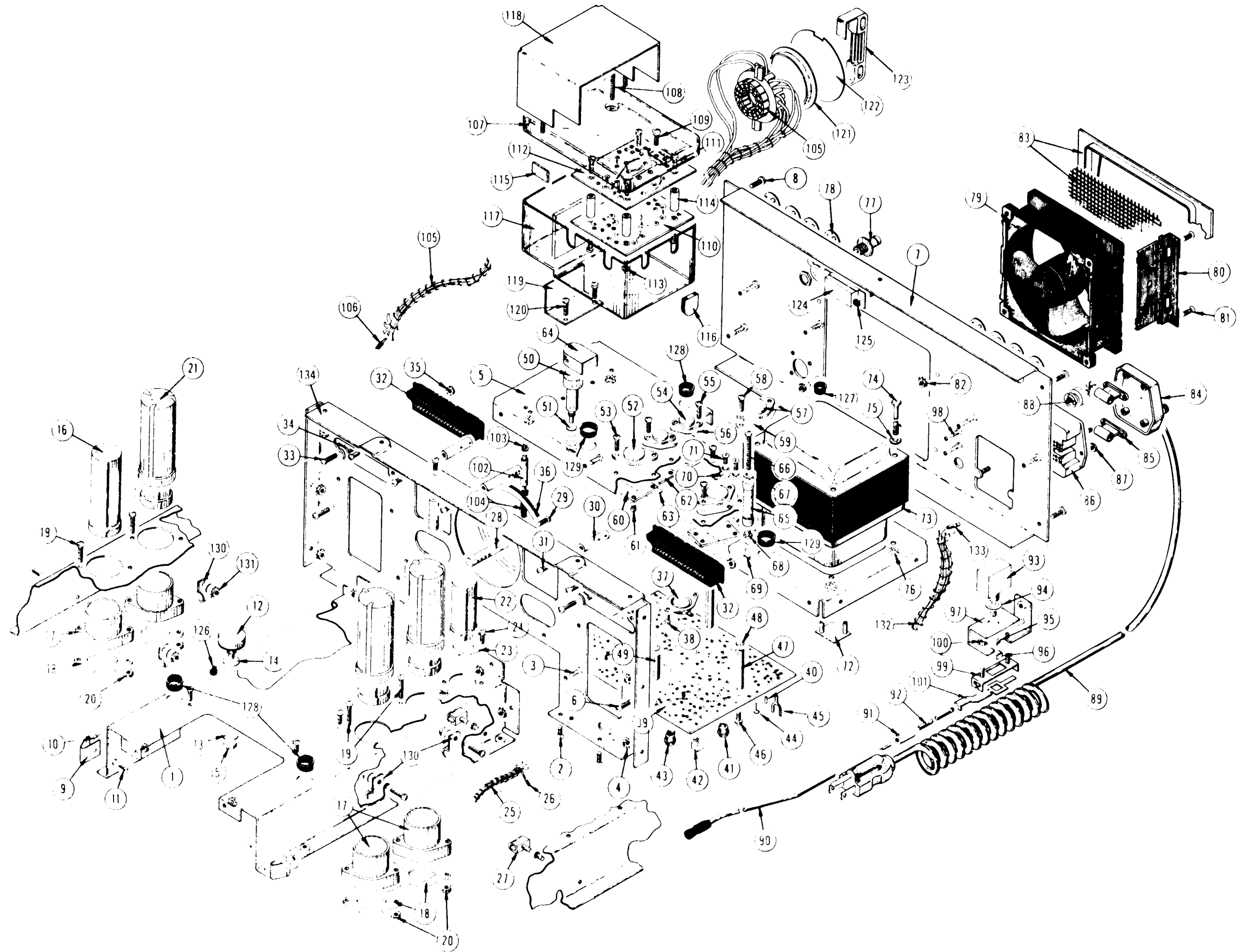

FIG. 2 REAR

THIS PAGE CURRENTLY NOT AVAILABLE FOR DIGITIZATION

8-28

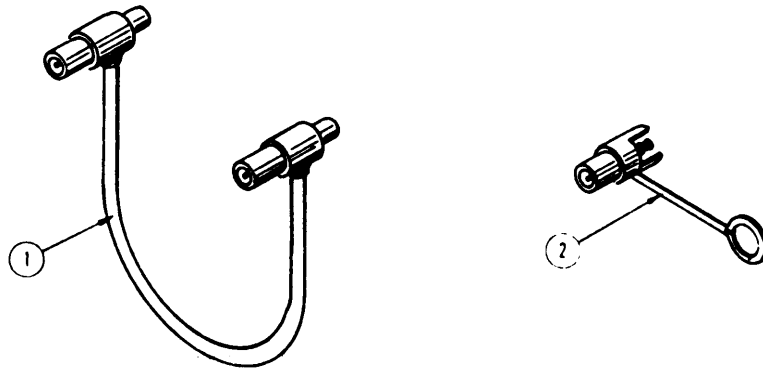

FIG. 3. STANDARD ACCESSORIES

[A]

FIG. 3. ACCESSORIES

Fig. & Index No.	Tektronix Part No.	Serial/Model No.		Quantity	1 2 3 4 5					Description	
		Eff	Disc								
3-1	012-0087-00			1							CORD, patch
-2	012-0092-00			1							JACK, BNC-post
	016-0131-00			1							HARDWARE KIT (not shown)
	070-0803-00			2							MANUAL, instruction (not shown)

MECHANICAL PARTS LIST—TYPE R5618

SECTION 9 DIAGRAMS

The following special symbols are used on the diagrams:

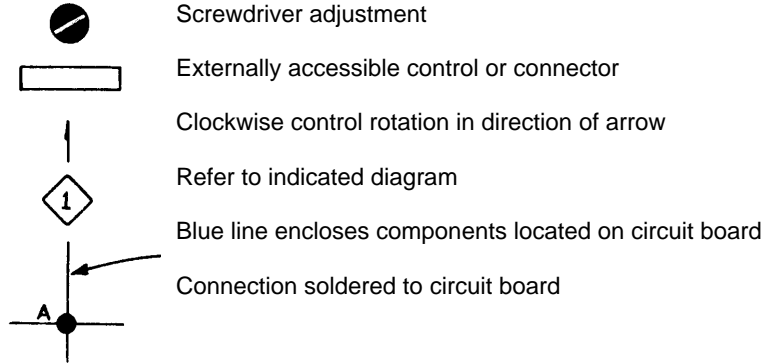

IMPORTANT VOLTAGE AND WAVEFORM CONDITIONS

Circuit voltages measured with an electronic voltmeter, having an input resistance of 100 M Ω , $\pm 5\%$, and a meter accuracy of $\pm 2\%$. Voltages are measured with respect to chassis ground unless otherwise noted. If a 20,000 Ω /volt VOM is used, the effects of circuit loading at high impedance points must be taken into consideration.

Waveforms shown are actual photographs taken with a Tektronix Oscilloscope Camera System and Projected Graticule.

Voltages and waveforms on the schematics (shown in blue) are not absolute and may vary between instruments because of component tolerances (or possible circuit loading of the voltmeter.)

The test oscilloscope used had the following characteristics: Minimum deflection factor, 0.1 volts/division using a 10X probe; frequency response, DC to 10 MHz. DC input coupling was used.

(Cont on next diagram)

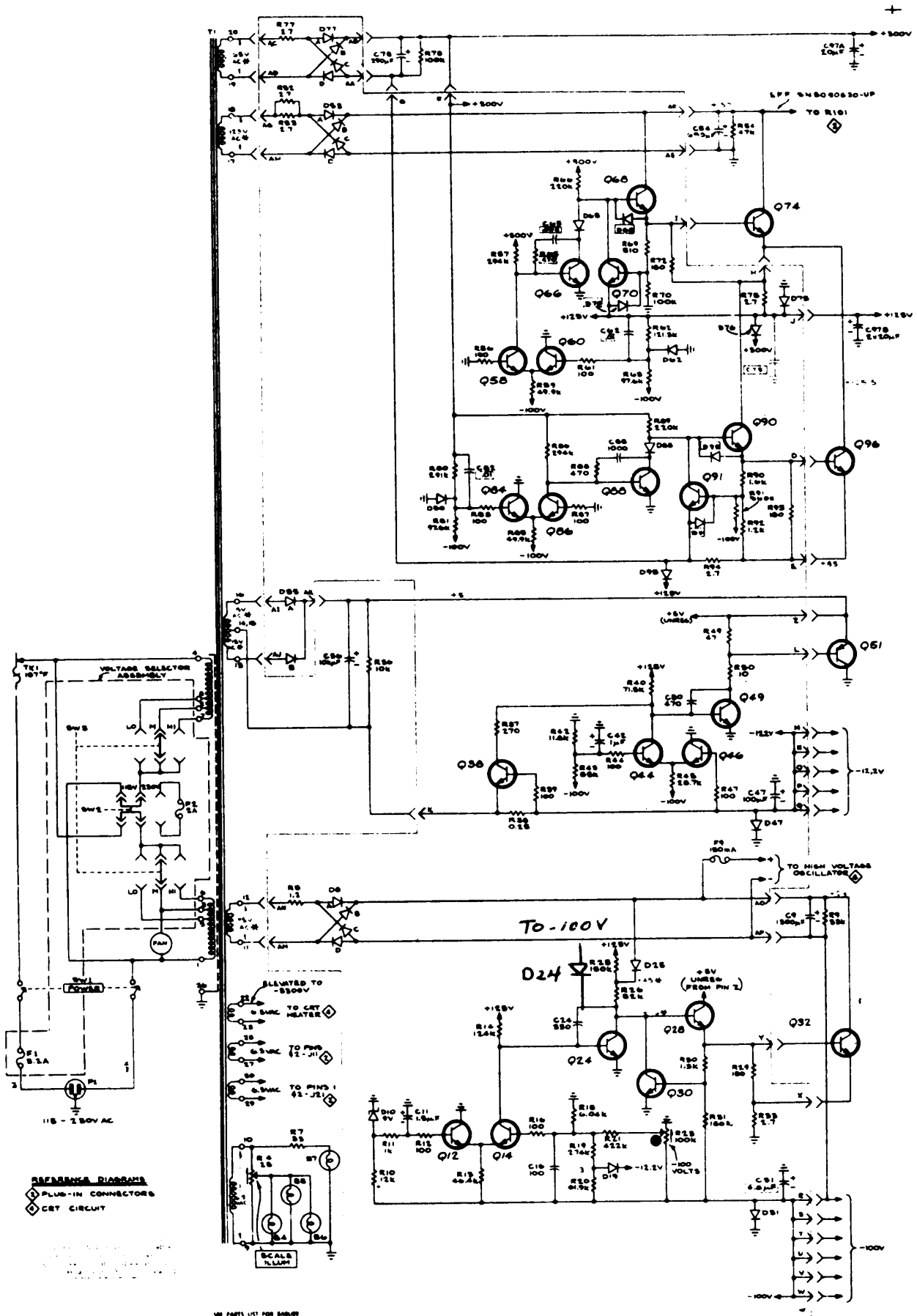

TYPE R5618

SEE PARTS LIST FOR SYMBOL VALUES AND SERIAL NUMBER RANGES OF PARTS MARKED WITH THIS OUTLINE

SEE PARTS LIST FOR SEMICONDUCTOR TYPES

POWER SUPPLY

THIS PAGE CURRENTLY NOT AVAILABLE FOR DIGITIZATION

Voltage readings and wave forms were obtained under the following conditions unless otherwise noted on the individual diagrams:

TYPE R561B

INTENSITY	Counterclockwise
FOCUS	Centered
SCALE	Counterclockwise
ASTIGMATISM	Centered
CALIBRATOR	40V
CRT CATHODE SELECTOR	NORM

Amplifier Unit

Position	Centered
Mode	Normal (Channel 1)
Volts/Div	5
Input Coupling	GND

Time-Base Unit

Position	Centered
Time/Div	1 ms
Sweep Mode	Normal
Level	Free run (clockwise)
Triggering Source	Internal
Triggering Slope	+
Triggering Coupling	Auto

Line voltage	115 VAC
Signal applied	None

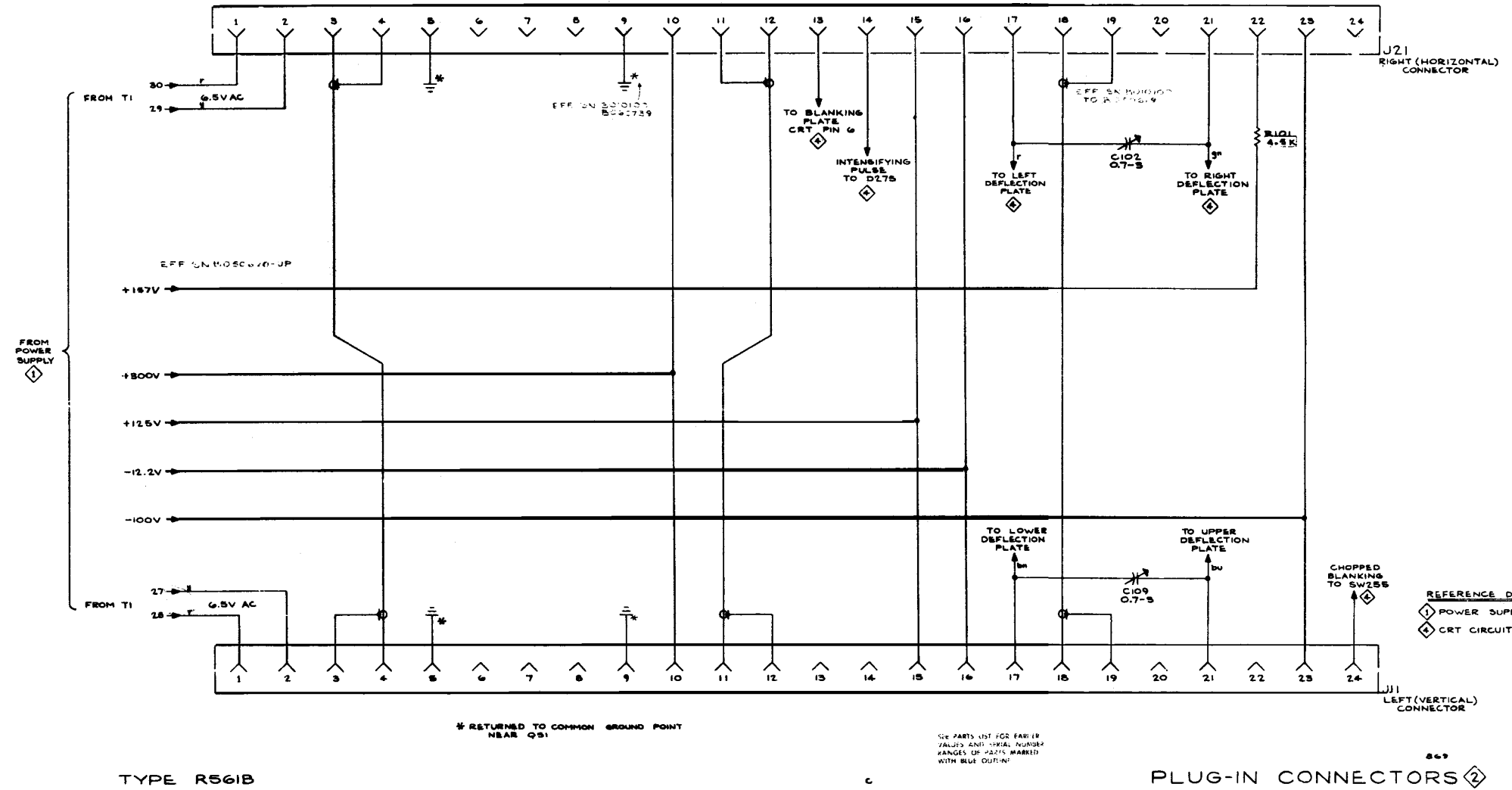

THIS PAGE CURRENTLY NOT AVAILABLE FOR DIGITIZATION

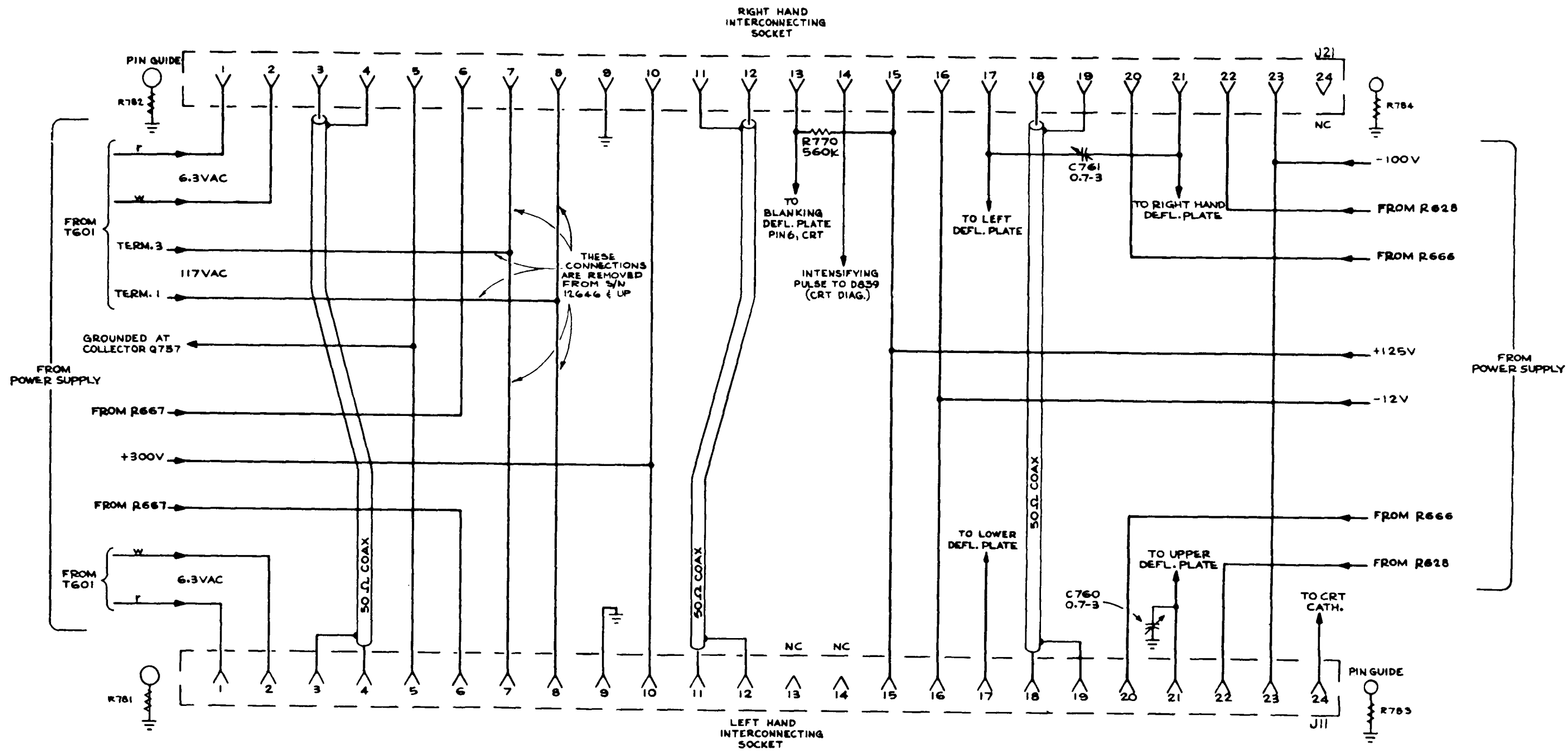

TYPE RM561A OSCILLOSCOPE

160
TR
INTERCONNECTING SOCKETS

D

SEE PARTS LIST FOR EARLIER
VALUES AND SERIAL NUMBER
RANGES OF PARTS MARKED
WITH BLUE OUTLINE.

THIS PAGE CURRENTLY NOT AVAILABLE FOR DIGITIZATION

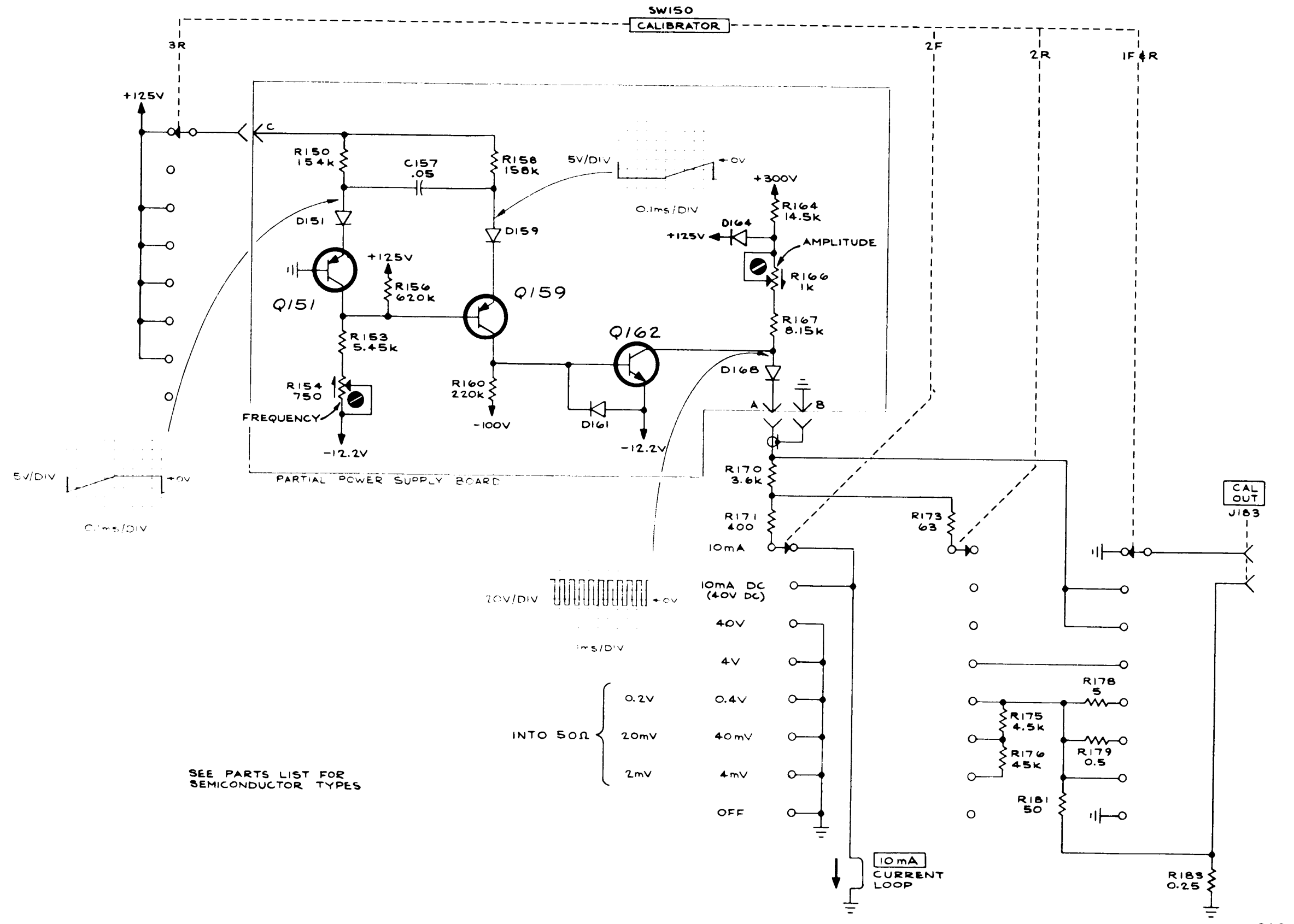

TYPE R561B

VOLTAGES and WAVEFORMS obtained under conditions given in Diagram 1.

A

1kHz CALIBRATOR 3

868

THIS PAGE CURRENTLY NOT AVAILABLE FOR DIGITIZATION

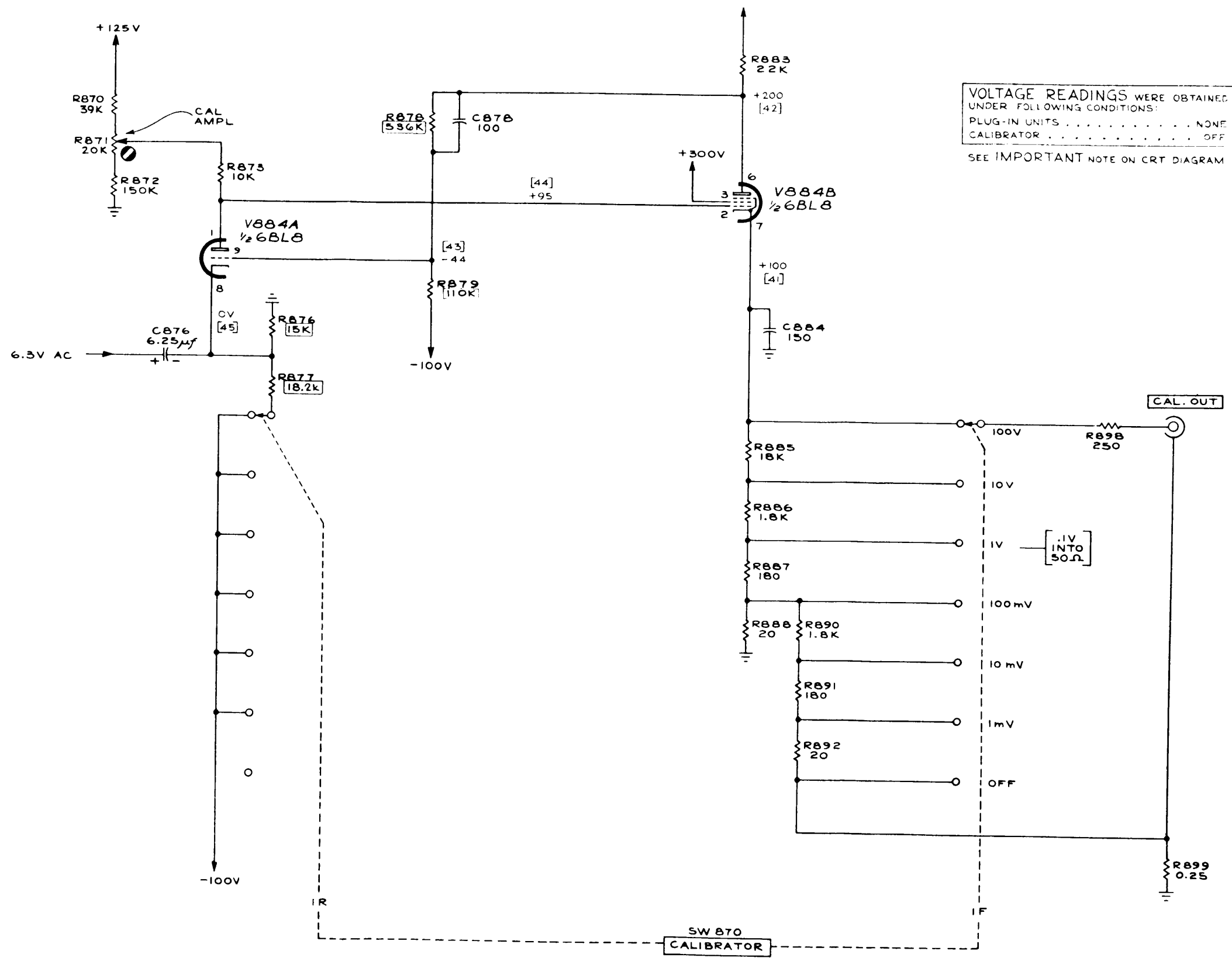

VOLTAGE READINGS WERE OBTAINED
 UNDER FOLLOWING CONDITIONS:
 PLUG-IN UNITS NONE
 CALIBRATOR OFF
 SEE IMPORTANT NOTE ON CRT DIAGRAM

561A OSCILLOSCOPE

SEE PARTS LIST FOR EARLIER
 VALUES AND S/N CHANGES OF
 PARTS MARKED WITH BLUE
 OUTLINE

568
 PLM
 CALIBRATOR

THIS PAGE CURRENTLY NOT AVAILABLE FOR DIGITIZATION

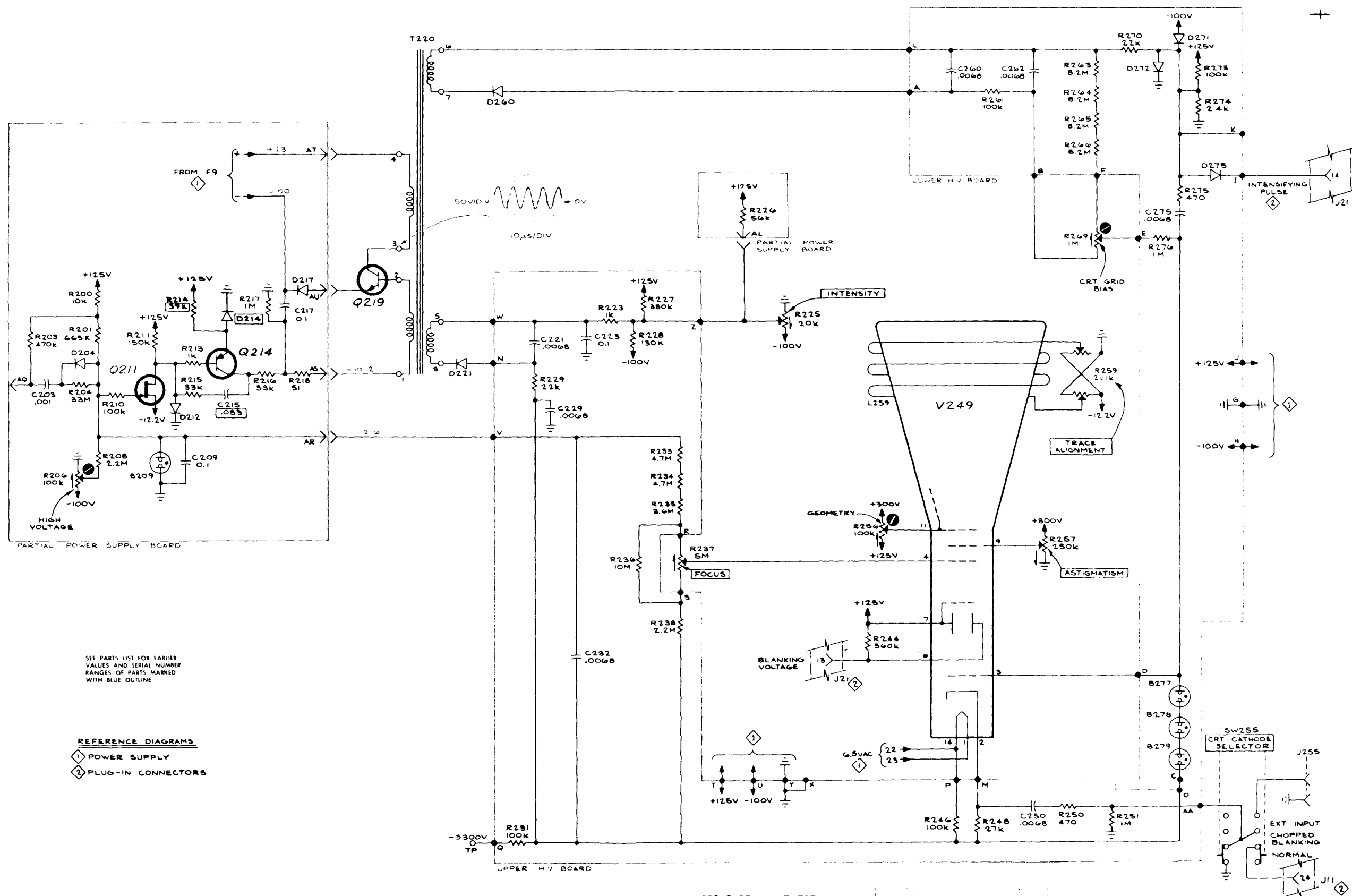

SEE PARTS LIST FOR EARLIER VALUES AND SERIAL NUMBER RANGES OF PARTS MARKED WITH BLUE OUTLINE

REFERENCE DIAGRAMS
 ① POWER SUPPLY
 ② PLUG-IN CONNECTORS

SEE PARTS LIST FOR SEMICONDUCTOR TYPES

VOLTAGES and WAVEFORMS shown under conditions given in Diagram 1.

TYPE R561B

CRT CIRCUIT ④

THIS PAGE CURRENTLY NOT AVAILABLE FOR DIGITIZATION

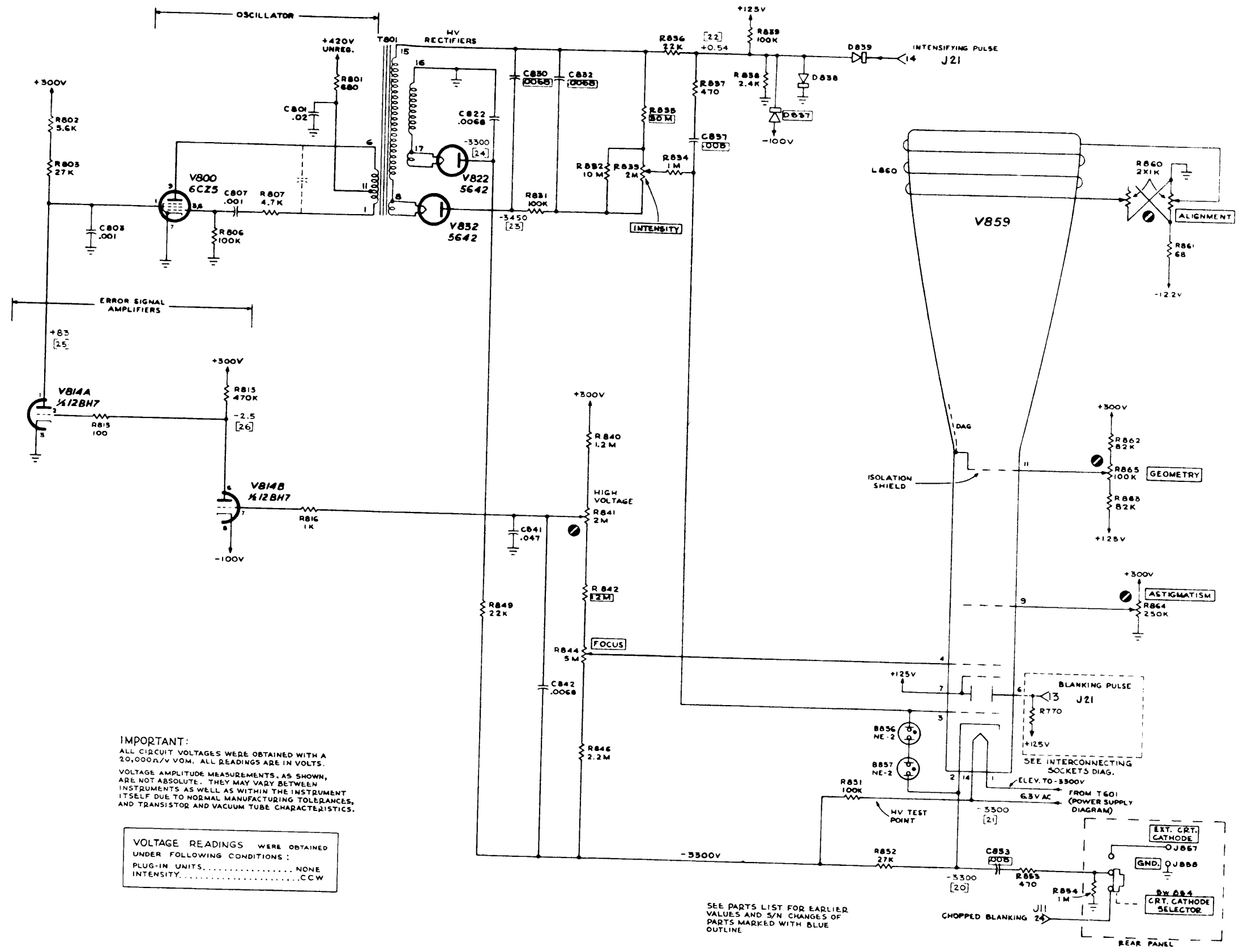

IMPORTANT:
 ALL CIRCUIT VOLTAGES WERE OBTAINED WITH A 20,000Ω/V VOM. ALL READINGS ARE IN VOLTS.
 VOLTAGE AMPLITUDE MEASUREMENTS, AS SHOWN, ARE NOT ABSOLUTE. THEY MAY VARY BETWEEN INSTRUMENTS AS WELL AS WITHIN THE INSTRUMENT ITSELF DUE TO NORMAL MANUFACTURING TOLERANCES, AND TRANSISTOR AND VACUUM TUBE CHARACTERISTICS.

VOLTAGE READINGS WERE OBTAINED UNDER FOLLOWING CONDITIONS:
 PLUG-IN UNITS.....NONE
 INTENSITY.....CCW

SEE PARTS LIST FOR EARLIER VALUES AND S/N CHANGES OF PARTS MARKED WITH BLUE OUTLINE

TYPE RM561A OSCILLOSCOPE

CRT CIRCUIT
 CIRCUIT NUMBERS 800 THRU 869

SECTION 10

PREVENTIVE MAINTENANCE INSTRUCTIONS

1. Scope Maintenance

The maintenance duties assigned to operator and organizational repairman of this equipment are listed below with a reference to the paragraphs covering the specific maintenance functions. The preventive maintenance procedures require no special tools or test equipment.

- a. Daily preventive maintenance check and services (para 6).
- b. Weekly preventive maintenance checks and service (para 6).
- c. Monthly preventive maintenance checks and service (para 7).
- d. Quarterly preventive maintenance checks and service (para 9).
- e. Cleaning (para 11).
- f. Touchup painting instruction (para 10.12).

10.2. Materials Required for Maintenance

- a. Trichloroethane (6810-292-9625).

WARNING

The fumes of trichloroethane are toxic. Provide thorough ventilation whenever used. Do NOT use near an open flame. Trichloroethane is not flammable but exposure of the fumes to an open flame converts the fumes to highly toxic, dangerous gases.

- b. Cleaning cloth.
- c. Fine sandpaper.
- d. Touchup pint.

3. Preventive Maintenance

Preventive maintenance is the systematic care, servicing, and inspection of equipment to prevent the occurrence of trouble, to reduce downtime and to assure that the equipment is serviceable.

a. *Systematic Care.* The procedure given in paragraphs 4 through 12 covers routine systematic care and cleaning essential to proper upkeep and operation of the equipment.

b. *Preventive Maintenance Checks and Services.* The maintenance checks and service charts outline functions to be performed at specific intervals. These checks and services are to maintain equipment in a combat serviceable condition; that is, in good general (physical) condition and in good operating condition. To assist operators in maintaining combat serviceability, the charts indicate what to check, how to check, and the normal conditions. The reference column lists the paragraphs that contain additional information. If the defect cannot be found by performing the corrective action indicated, a higher category of maintenance or repair is required. Records and reports of these checks and services must be made in accordance with the requirements set forth in TM 38-750.

4. Preventive Maintenance Checks and Service Periods

Preventive maintenance checks and service of this equipment are required daily, weekly, monthly, and quarterly. Daily maintenance and weekly are specified in paragraph 5. Paragraph 6 specifies checks and servicing that must be performed weekly. If the equipment is maintained in a standby condition, the daily and weekly checks should be accomplished at the same time. The maintenance checks and services that are accomplished monthly are specified in paragraph 7. Quarterly maintenance checks and services are specified in paragraph 9.

5. Daily Preventive Maintenance Checks and Services Chart

Sequence	Items to be Inspected	Procedure	Reference
1	Completeness	See that the equipment is complete.	Appendix B Paragraph 11
2	Cleanliness	Exterior of equipment must be clean and dry, free of fungus, dirt, dust, and grease.	
3	Operational check	Check the operational efficiency.	
4	Controls	See that controls operate smoothly and are fastened in place securely.	

6. Weekly Preventive Maintenance and Services Chart

Sequence	Items to be Inspected	Procedure	Reference
1	Cables	Inspect cards and cables for chafed, cracked, or frayed insulation. Replace connectors that are broken, stripped, or worn.	Paragraphs 11 and 12
2	Metal surfaces	Inspect exposed metal surface for rust and corrosion. Clean and touchup with paint as required.	

7. Monthly Maintenance

once each month. Periodic daily (para. 5) and weekly (para. 6) services constitute a part of the monthly checks.

Perform the maintenance functions indicated in the monthly-preventive maintenance checks and services chart (para. 8)

8. Monthly Preventive Maintenance Checks and Services Chart

Sequence	Items to be Inspected	Procedure
1	Terminations	Inspect for loose connections and cracked or broken insulation.
2	Control panel	Clean panel thoroughly and check all surfaces for chips, cracks, and abnormal wear.
3	Hardware	Inspect all hardware for possible damage.

9. Quarterly Maintenance

Quarterly preventive maintenance checks and services are required for the equipment. Periodic daily, weekly, and monthly services constitute a part of the quarterly preventive maintenance checks and services and must be performed concurrently. All deficiencies or shortcomings will be recorded

in accordance with the requirements of TM 38-750. Perform all the checks and services listed in the quarterly preventive maintenance checks and services chart (para 10) in the sequence listed. Adjustment of the maintenance interval must be made to compensate for any unusual operating conditions.

10. Quarterly Preventive Maintenance Checks and Services Chart

Sequence	Items to be Inspected	Procedure	Reference
1	Publications	See that all publications are complete, serviceable, and current.	DA Pam 310-4
2	Modifications	Check DA Par 310-7 to determine whether new applicable MWO's have been published. All URGENT MWO's must be applied immediately. All normal MWO's must be scheduled.	TM 38-750 and DA Pam 810-7

THIS PAGE CURRENTLY NOT AVAILABLE FOR DIGITIZATION

11. Cleaning

Inspect the exterior surfaces. The surfaces must be free of dust, dirt, grease, and fungus.

a. Remove dust and loose dirt with a clean, soft cloth.

b. Remove grease, fungus, and ground-in dirt. Use a damp cloth (not wet) with trichloroethane to clean terminations. If dirt on the body of the unit is difficult to remove, use mild soap and water.

c. Remove dust or dirt from the jacks and plugs with a brush.

12. Touchup Painting Instructions

Remove dust and corrosion from metal surface by lightly sanding them with fine sandpaper. Brush two thin coats of paint on the bare metal to protect it from further corrosion. Refer to applicable cleaning and refinishing practices specified in TB 746-10.

SECTION 11 RACKMOUNTING

Introduction

This instrument is designed to mount in a standard 19-inch rack. Any one of three mounting methods may be used. When properly mounted, this instrument will meet all the electrical and environmental specifications given in Section 1 of this manual.

Rack Dimensions

Height. At least seven inches of vertical space is required to mount this instrument in a rack.

Width. Minimum width of the opening between the left and right front rails of the rack must be $17\frac{5}{8}$ inches for a rack in which the front flange of the slide-out track stationary section is mounted behind the front rail, $17\frac{3}{4}$ inches if the flange is mounted in front of the rail, or $17\frac{3}{16}$ inches if the instrument is mounted in a cradle assembly. This allows space on each side of the instrument for the slide-out tracks to operate freely and permit the instrument to move smoothly in and out of the rack.

Depth. Total depth necessary to mount the instrument in a cabinet rack is $22\frac{1}{2}$ inches. This allows space for air circulation, power cord connection, and the necessary mounting hardware.

Determining the Mounting Method

Use Method 1 (Fig. 11-1A) if the instrument is to be mounted directly to the front rail of the rack. Use Method 2 (Fig. 11-1B) if the instrument is to be mounted in the rack with slide-out tracks, and the rack has both front and rear vertical rails. Use Method 3 (Fig. 11-1C) for racks that have only the front rails, or do not have the proper dimensions between the front and rear rails. Methods 2 and 3 require the addition of optional accessories.

Enough space should be provided between the rear of the instrument and any obstruction at the rear of the rack to allow for proper air circulation and power cord clearance.

Method 1—Direct Rackmounting

This type of mounting is intended for instruments which are not equipped with slide-out tracks. The front panel of the instrument has two notches on each side so the instrument can be mounted directly to the front rail of the rack. When mounted in this manner, the rear of the instrument does not need support unless subjected to shock or vibration. Braces can be added at the rear of the instrument if more support is needed.

(A)

To mount the instrument directly to the front rails of the rack (see Fig. 11-1.A) proceed as follows:

1. Select four oval-head screws (10-32 or 12-24) that match the tapped holes in the rack front vertical rail from the hardware kit included with the instrument. If the holes in the front rail are not tapped, nuts, washers and longer screws must be used.
2. First, place a finishing washer and then a Teflon washer on each screw. The Teflon washers will protect the instrument front panel.
3. Hold the instrument in the desired position in the rack and fasten securely to the front rail with the oval-head screws.

Method 2—Rackmounting With Slide-out Tracks

An instrument equipped with slide-out tracks (optional item) can be mounted in a rack which has a rear support rail, as shown in Fig. 11-1B. When the instrument is released from the rack, it can be pulled out to the fully extended position and tilted up or down and locked in any one of six positions: 45° , 90° and 105° above or below horizontal. These positions permit most routine maintenance and calibration functions to be performed without removing the instrument from the rack.

The slide-out tracks consist of two assemblies as shown in Fig. 11-2; one for the right side and one for the left. Each assembly consists of three sections. The stationary section attaches to the front and rear rails of the rack and the chassis section attaches to the sides of the instrument. The intermediate section fits between the stationary and chassis sections and allows the instrument to be extended out of the rack. The stationary and intermediate sections are shipped as matched sets and should not be separated.

The small-hardware components included with the slide-out tracks are shown in Fig. 11-3 and 11-4. The hardware shown in Fig. 11-3 is used to mount the stationary sections to the rack. The hardware shown in Fig. 11-4 is used to mount the chassis sections to the sides of the instrument. Since the hardware included is intended to make the slide-out tracks compatible to a variety of racks, there will be more parts than needed for this installation. Use only the necessary hardware as described in the following procedures.

Chassis Section Installation. Use the following procedure to attach the chassis sections if they are not already installed. See Fig. 11-4 for installation details.

1. Remove the plug-in units (if any) from their compartments.
2. Remove the bottom dust cover from the instrument.

3. The chassis section parts are held together by the eccentric pivot screw and a nut. Remove the nut, lockwasher and flat washer from the pivot screw, holding the assembly so that it does not fall apart.

4. Mount the assembly to the side of the instrument, placing the pivot screw through the hole provided. The holes in the detent bar assembly must be aligned with the pre-punched holes on the side of the instrument.

5. Replace the hardware removed in step 3. Do not tighten the nut.

6. Fasten the detent bar assembly to the instrument side, using six 8-32 binder-head screws. Align the detent bar so it is parallel to the bottom of the instrument before tightening the screws.

7. Turn the eccentric pivot screw until the outer slide is parallel to the bottom of the instrument. Hold the screw in this position and tighten the nut.

8. Make sure the detent release knob is screwed tightly into the detent bar. Release the detent and check that the outer slide portion pivots freely on the pivot screw.

Ruggedizing Rear-Support Hardware Installation. (Optional). If the installation requires a high degree of physical rigidity, the ruggedizing hardware shown in Fig. 11-5 should be used.

1. Mount the two securing bushings to the rear of the instrument, placing from inside the instrument a ¼-20 hex-head screw through each ¼-inch hole provided.

2. Locate the bar supports on the rear rails at the correct position for mounting the rear of the stationary sections of the slide-out tracks (see Fig. 11-6). Using the 10-32 round-head screws provided, securely attach the bar supports to the rear rails.

NOTE

If the distance between the front and rear rails is greater than 18 inches, the rear mounting brackets shown in Fig. 11-3 must be used. Mount the rear-support ruggedizing hardware directly to the rear mounting bracket after the stationary sections have been installed. See Fig. 11-11.

3. Assemble the support pin, neoprene support washer, spacer, washers, lockwasher and ¼-20 hex-head screw to each angle bracket.

4. Loosely attach the support pin assemblies and spacer blocks to the bar supports. The holes in the angle brackets are slotted to permit alignment of the support pins with the securing bushings on the rear of the instrument.

Stationary Section Installation. A wide variety of mounting methods is available for installing the stationary sections in the rack, as shown in Figs. 11-8 and 11-9. The following factors should be taken into consideration when choosing the mounting method for a particular installation:

- (a) Depth of rack.
- (b) Degree of mechanical stability required.

(c) Mounting method for other instruments in the rack, and the relative thickness of the front panels of the various instruments in the rack.

(d) Type of mounting holes in the supporting rails; that is, whether they are tapped, clear or countersunk.

(e) General appearance desired for the completed rack assembly.

As mentioned previously the stationary and intermediate sections are matched sets and should not be separated. To distinguish between the right and left stationary/intermediate assemblies, note the position of the automatic etc. (refer to Fig. 11-2). The automatic latch should be located near the bottom of the assembly when it is installed in the rack. Use the following procedure to mount both sets:

1. Referring to Fig. 11-7 select the proper front-rail mounting holes for the stationary sections.

2a. If the mounting holes are tapped for 10-32 screws and the distance between the front vertical rails is a minimum of 17¾ inches, the left stationary section can be mounted in front of the rail as shown in Fig. 11-8C.

2b. If the mounting holes are not tapped for 10-32 screws, or if the distance between the front rails is less than 17¾ inches, mount the left stationary section behind the front rail as shown in Fig. 11-9C. (Note: If the distance between the front rails is less than specified but the mounting holes are tapped, the mounting holes should be drilled clear.)

3. Mount the right stationary section to the right front rail.

4. With the front end of each stationary section attached to the front rail, hold the track in a level position in the rack and locate the proper rear-rail mounting holes.

5. Using Figs. 11-8 and 11-9 as a guide, attach the rear mounting brackets to the rear rails using 10-32 pan-head screws.

6. Fasten the rear of each stationary section to the rear mounting brackets, using 10-32 pan-head screws, spacers and bar nuts.

Alignment Procedure

Replace the bottom dust cover that was removed earlier. Referring to Fig. 11-10, insert the instrument into the rack. Do not connect the power cord and do not install the securing screws. Use the following procedure to adjust the instrument alignment in the rack.

1. Position the instrument approximately half way out of the rack so that the point of rotation on each chassis section is adjacent to the front rail of the rack.

2. Loosen the mounting screws holding the front mounting flanges to the front rails.

3. Hold the instrument in the center of its mounting space and retighten the front mounting screws.

4. Push the instrument all the way into the rack and check the vertical and horizontal alignment of the front panel of the instrument. If necessary, readjust the positioning as described in steps 2 and 3.

5. Push the instrument all the way into the rack again and install one oval-head securing screw on each side of the front

panel using a finishing washer and Teflon washer as shown in Fig. 11-10. If the front rails are not tapped for either the 10-32 or 12-24 oval-head screws, some other means of securing the instrument into the rack must be provided.

NOTE

If the rear-support ruggedizing hardware is used, the instrument may not slide all the way into the rack easily. Check the fit of the ruggedizing hardware before installing the securing screws.

6a. If the ruggedizing hardware is not used, the alignment procedure is complete at this point. The power cord may now be connected to a suitable power source and the, plug-in units installed into their proper compartments.

6b. If the ruggedizing hardware is used, check that each securing bushing is pressed over a support pin (refer to Fig. 11-11).

7. If the securing bushings and support pins fit tightly together, with the neoprene washers seated against the securing bushings, hold each angle bracket firmly in place and tighten the angle-bracket screws.

NOTE

If the securing bushing and support pin do not fit tightly together, determine what adjustment is necessary. Loosen and retighten hardware, or add more washers to give proper spacing, as necessary.

8. To provide a proper shock-mounted installation, the front panel of the instrument should be fastened to the front rails of the rack with four oval-head securing screws, as shown in Fig. 11-10. (Replace the bottom screw holding the front of

each stationary slide-out track section to the front rails with an oval-head securing screw.) Do not over tighten the securing screws so as to bend the front panel of the instrument.

9. The power cord may now be connected to a suitable power source and the plug-in units installed.

Method 3—Rackmounting With a Cradle Assembly

A cradle assembly (optional) can be used to mount the instrument in a rack which has only a front rail or does not have the proper dimensions between the front and rear rails (Fig. 11-1C). The cradle assembly provides a rear support for the slide-out tracks without affecting their operation. Additional bracing should be added to the rear of the cradle assembly if severe vibration or shock is anticipated.

Mounting instructions for this type of installation are included with the cradle assembly. The cradle assembly can be ordered from your **NICP**.

Slide-Out Track Lubrication

The special finish on the sliding surfaces of the slide-out tracks provides permanent lubrication. However, if the tracks do not slide smoothly even after being properly adjusted, a thin coating of paraffin may be rubbed onto the sliding surfaces for additional lubrication.

Removal and Re-insertion

After the initial installation and adjustment of the slide-out tracks, the instrument may be removed or re-inserted in the rack by following the instructions given in Fig. 11-10. Under normal circumstances, no further adjustments are required.

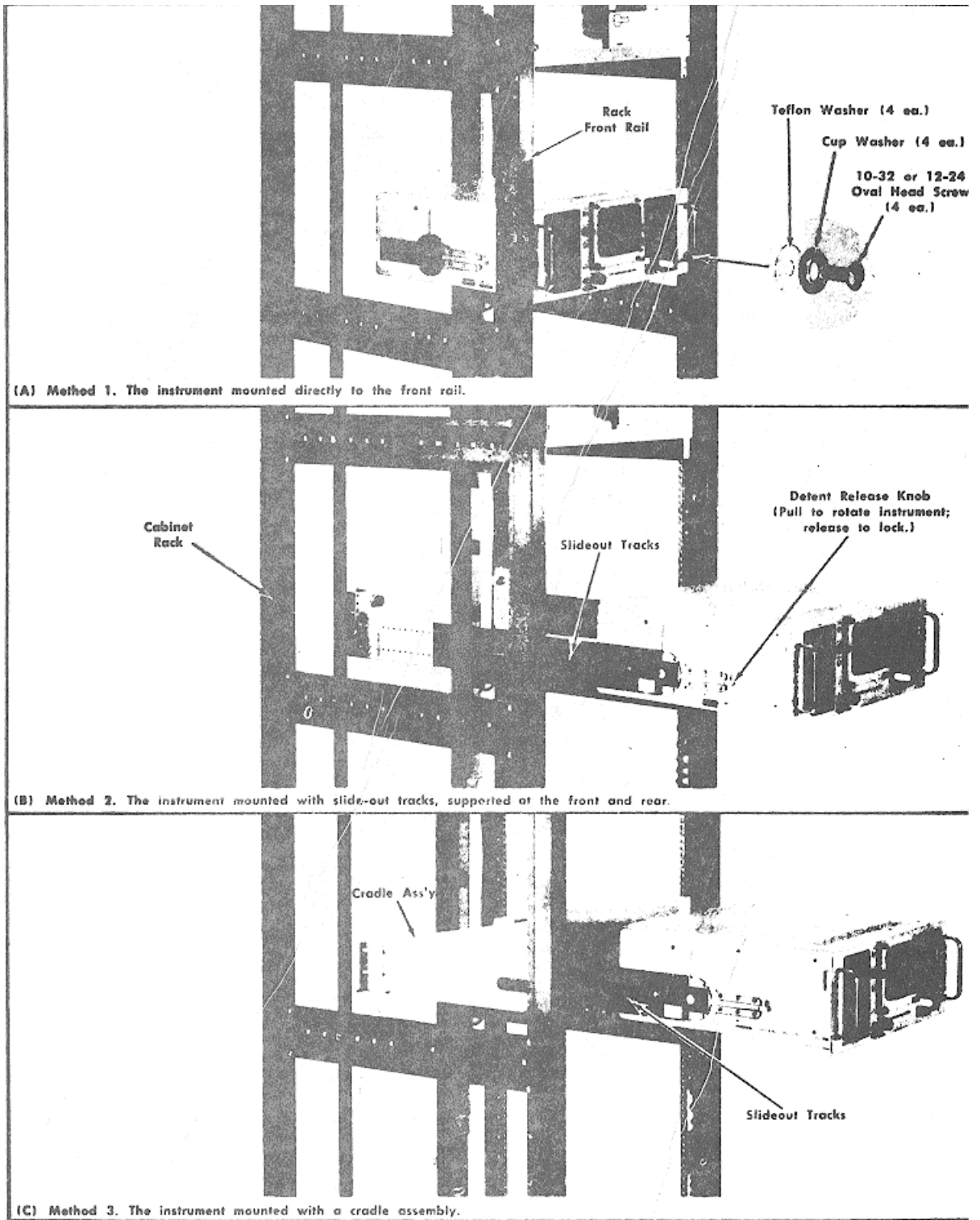

Fig. 11-1. Three methods of rack-mounting installation.

(A)

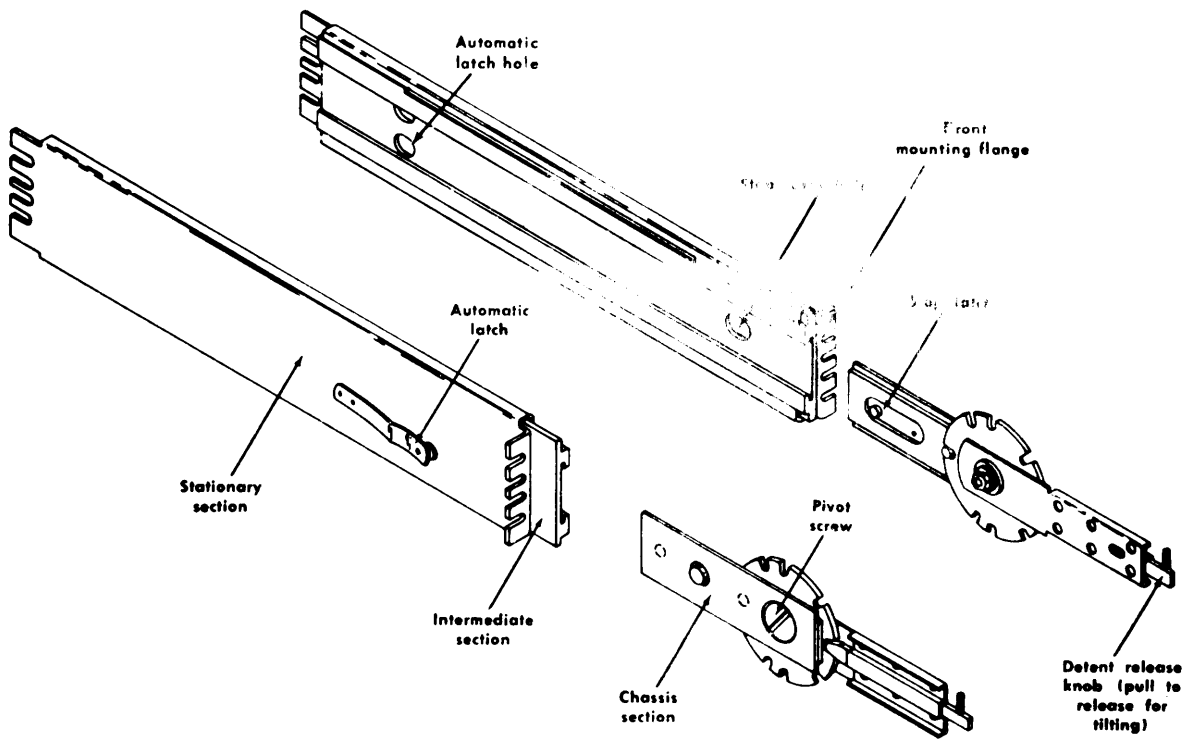

Fig. 11-2. Slide out track assemblies (optional items).

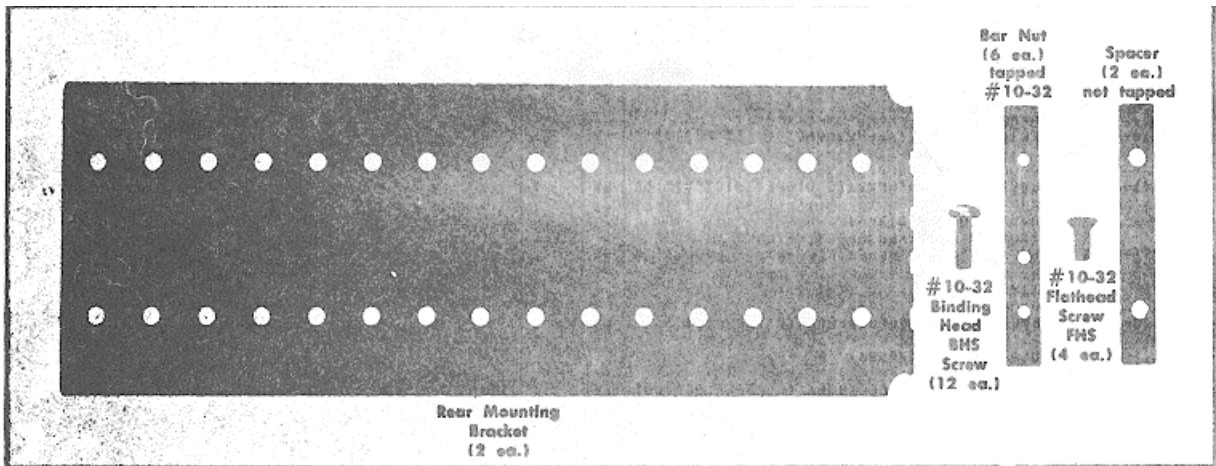

Fig. 11-3. Small hardware components for mounting the stationary sections to the rack rails (supplied with optional slide-out tracks).

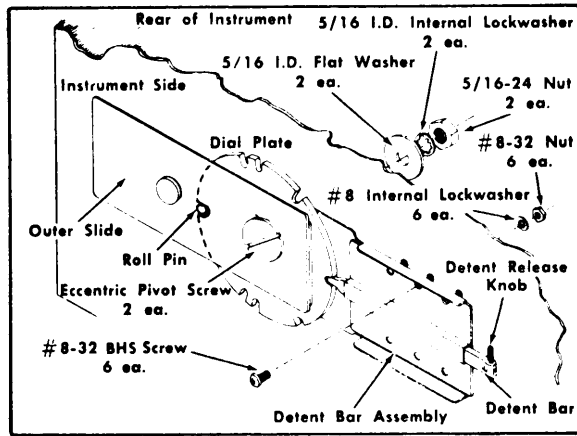

Fig. 11-4. Details for mounting the left chassis section to the instrument (supplied with optional slide-out tracks).

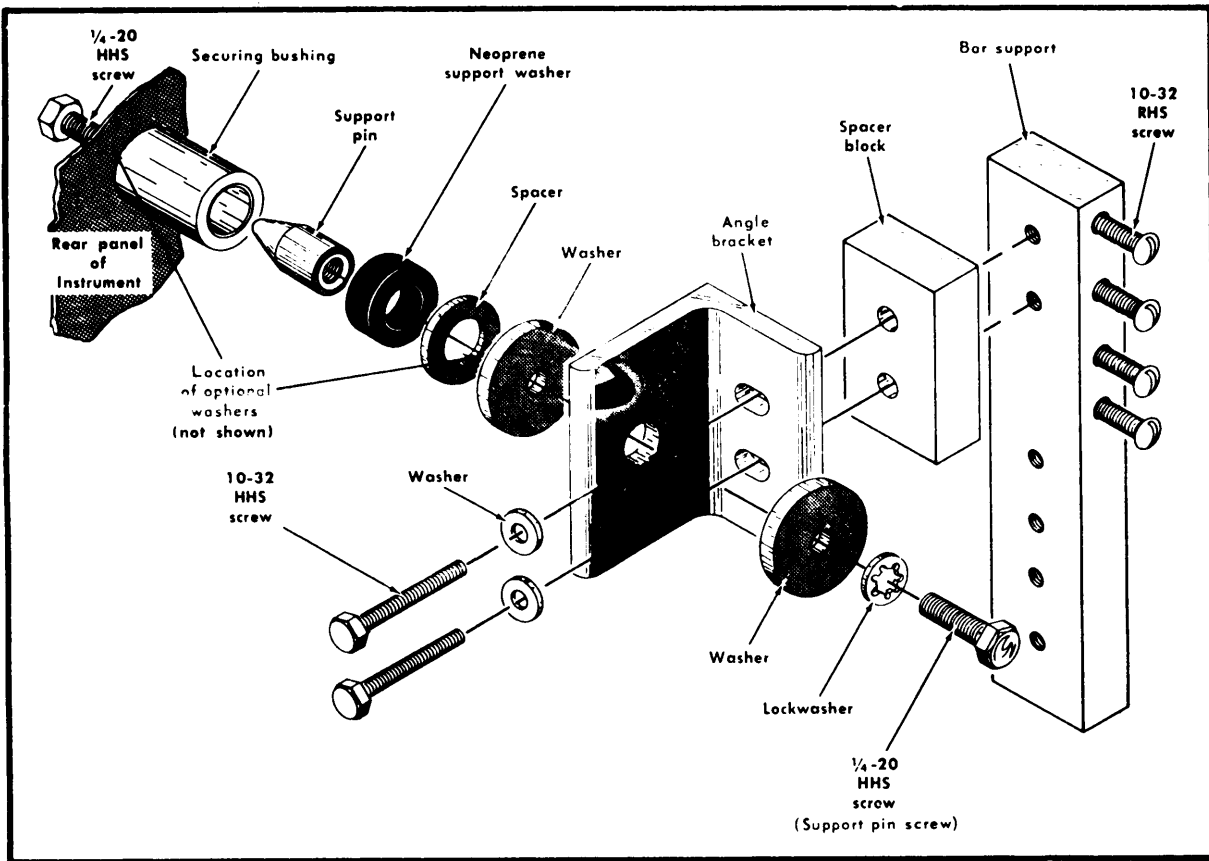

Fig. 11-5. Rear-support ruggedizing hardware (optional).

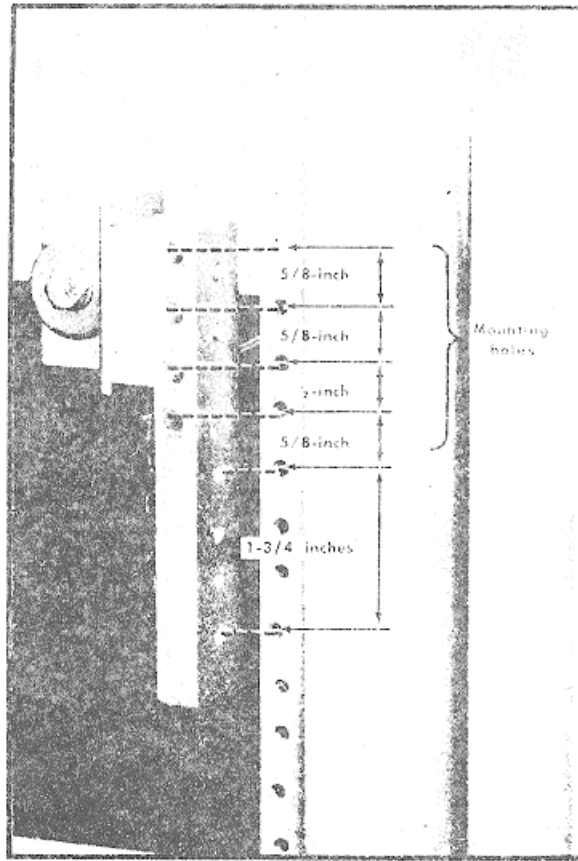

Fig. 11-6. Vertical mounting position for rear-support ruggedizing hardware in an 18-inch deep rack. Left side (only shown.)

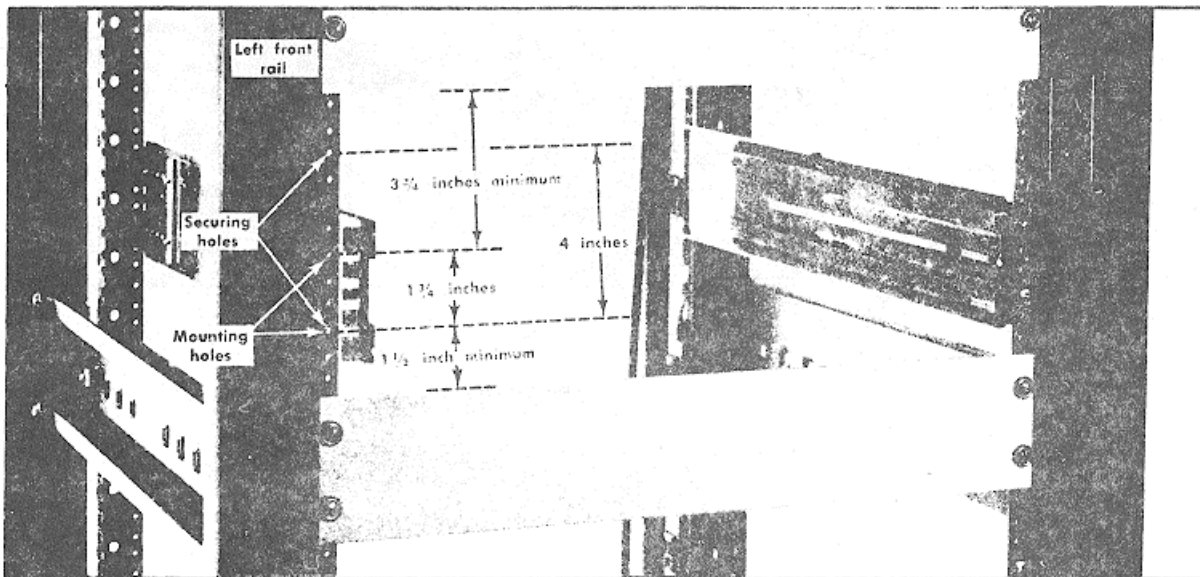

Fig. 11-7. Vertical mounting position for front end of slide-out tracks. Left stationary section (only) is shown.

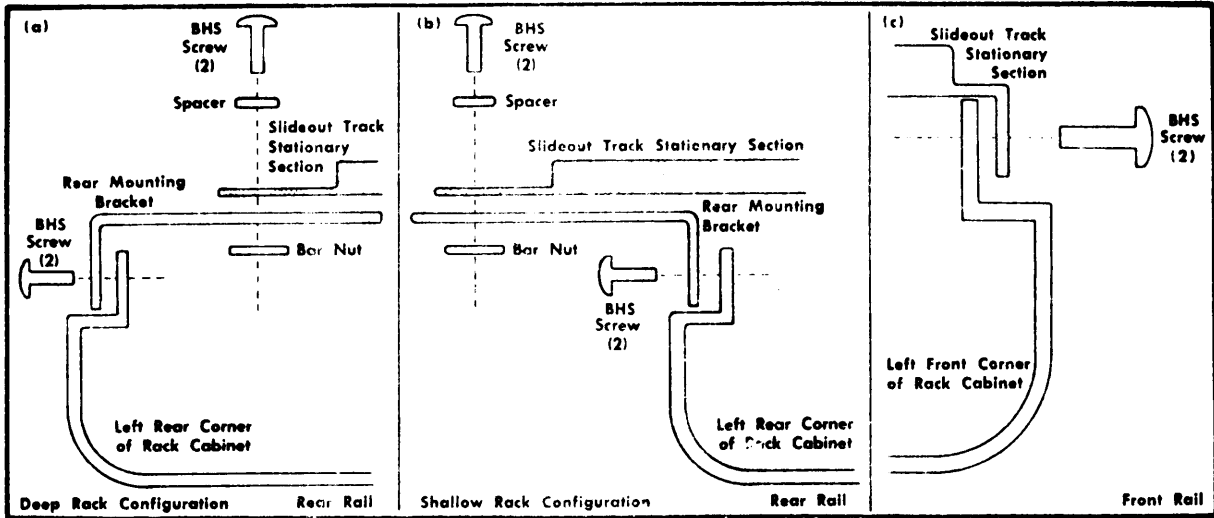

Fig. 11-8. Mounting the left stationary section to topped vertical rails.

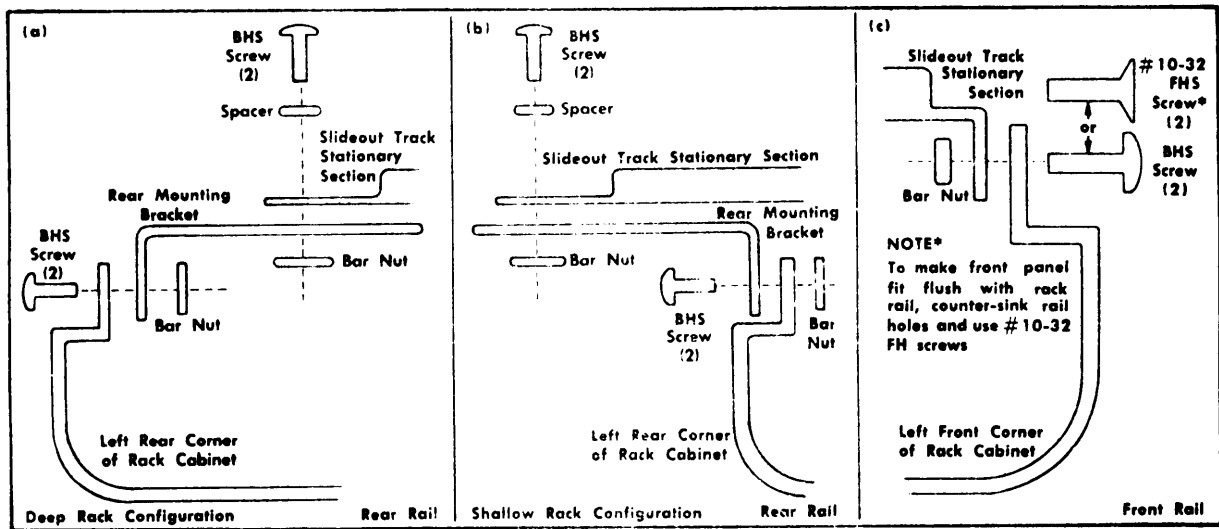

Fig. 11-9. Mounting the left stationary section to untapped vertical rails.

TO INSERT THE INSTRUMENT

1. Pull out the intermediate section (A) of each slide-out rack to its fully extended position.
2. Insert the chassis sections (B) into the intermediate sections and push the instrument in until the stop latches hit the intermediate sections.
3. Press both stop latches (C) and push the instrument in until the stop latches snap into the stop latch holes (D).
4. Press both stop latches (D) and push the instrument all the way into the rack.
5. Insert the securing screws (E), with finishing washers and Teflon washers, through the slots in the handle bracket and screw them into the front rails of the rack.
6. Connect power cord to a suitable power source.

TO REMOVE THE INSTRUMENT

1. Disconnect the power cord and remove the interconnecting cables from the rear-panel connectors.
2. Remove the securing screws and washers (E).
3. Pull the instrument outward until the stop latches snap into the stop latch holes and the automatic latches snap into the automatic latch holes.
4. Press both stop latches (D) and pull the instrument out of the rack.
5. Press the automatic latch in each intermediate section and push the track into the rack.

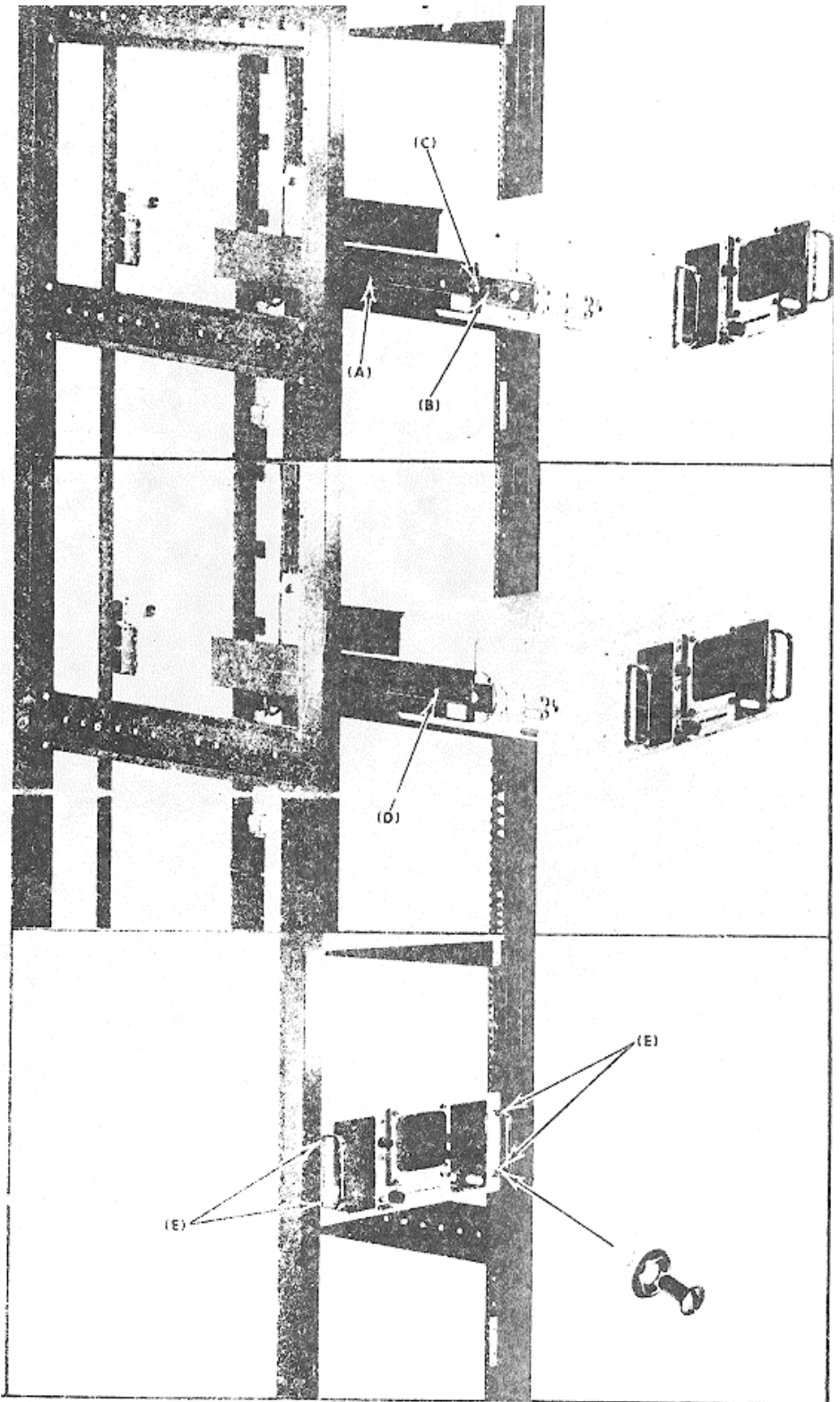

Fig. 11-10. Insertion and removal of the instrument after the slide-out tracks have been installed.

(A)

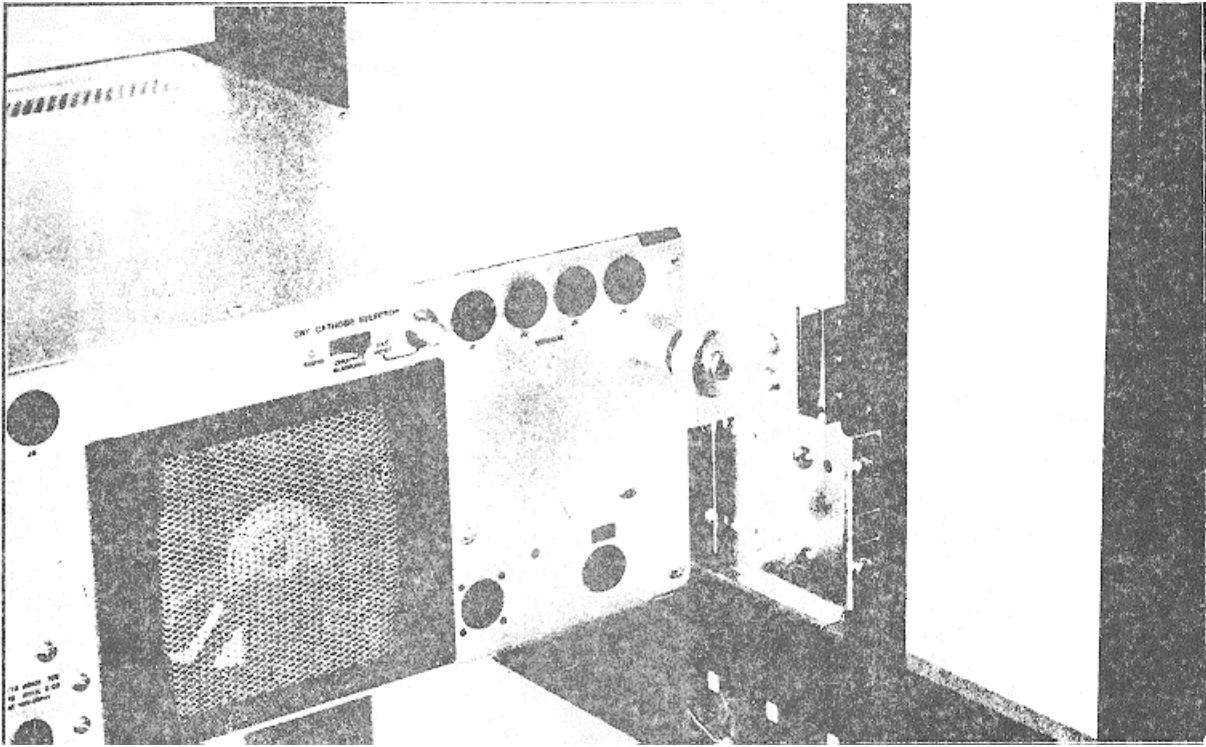

Fig. 11-11. Completed installation of left rear support in a 22½-inch deep rack.

SECTION 12

DIRECT SUPPORT AND GENERAL SUPPORT MAINTENANCE

REPAIR PARTS AND SPECIAL TOOLS LIST

INTRODUCTION

1. Scope. This RPSTL lists and authorizes spares and repair parts required for performance of direct and general support maintenance of Graphical Display System, Tektronix Type 561 Series. It authorizes the requisitioning, issue, and disposition of spares and repair parts as indicated by the Source, Maintenance and Recoverability (SMR) codes.

2. General. This Repair Parts and Special Tools List is divided as follows:

a. Repair Parts List. A list of spares and repair parts authorized by this RPSTL for use in the performance of maintenance. Parts lists are composed of functional groups in ascending numeric sequence. Parts are listed in alphabetical sequence within each figure number.

b. Special Tools List. Not applicable.

c. National Stock Number and Part Number Index. A list, in National Item Identification Number (NIIN) sequence, of all National Stock Numbered items (NSN) appearing in the listing, followed by a list in alphanumeric sequence of all part numbers appearing in the listing. NSN's and part numbers are cross-referenced to the figure and item number appearance.

3. Explanation of Columns (Section II)

a. Item No. (Column (1)). Indicates the number used to identify each item appearing in the listing.

b. SMR CODE (Column (2)). The Source, Maintenance, and Recoverability (SMR) code is a 5-position code containing supply/requisitioning information, maintenance category authorization criteria, and disposition instructions as shown in the following breakdown:

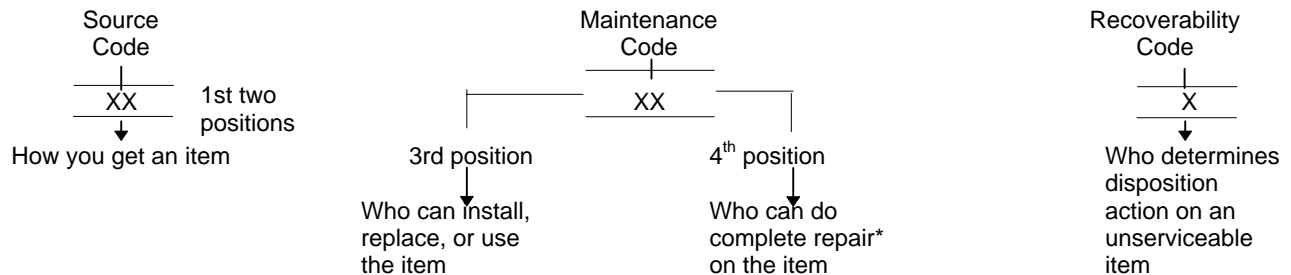

*Complete Repair: Maintenance capacity, capability, and authority to perform all the corrective maintenance tasks of the "Repair" function in a use/user environment in order to restore serviceability to a failed item.

(1) Source Code. The source code tells you how you get an item needed for maintenance, repair, or overhaul of an end item/equipment. Source codes are always the first two positions of the SMR code. Explanation of source codes follows:

Code	Explanation
PA -	Stocked items; use the applicable NSN to request/requisition items with this code. This item is authorized to the category indicated by the code entered in the 3d position of the SMR code.
XD -	Item is not stocked. Order an "XD" coded item through normal supply channels using the FSCM and part number given, if no NSN is available.

(2) Maintenance Code. Maintenance codes tell you the level(s) of maintenance authorized to USE and REPAIR support items. The maintenance codes are entered in the third and fourth positions of the SMR code as follows:

(a) The maintenance code entered in the third position tells you the lowest maintenance level authorized to remove, replace, and use an item. The maintenance code entered in the third position will indicate authorization to the following level of maintenance.

Code	Application/Explanation
F	- Direct support level can remove, replace, and use the item.

(b) The maintenance code entered in the fourth position tells you whether or not the item is to be repaired and identifies the lowest maintenance level with the capability to do complete repair (i.e., perform all authorized repair functions). This position will contain the following code.

Code	Application/Explanation
Z	- Nonreparable. No repair is authorized.

(3) Recoverability Code. Recoverability codes are assigned to items to indicate the disposition action on unserviceable items. The recoverability code is entered in the fifth position of the SMR code as follows:

Recoverability Codes	Definition
Z	- Nonreparable item. When unserviceable, condemn and dispose of the item at the level of maintenance shown in the third position of the SMR code.

c. FSCM (Column (3)). The Federal Supply Code for Manufacturer (FSCM) is a 5-digit numeric code which is used to identify the manufacturer, distributor, or Government agency, etc., that supplies the item.

d. PART NUMBER (Column (4)). Indicates the primary number used by the manufacturer (individual, company, firm, corporation, or Government activity), which controls the design and characteristics of the item by means of its engineering drawings, specifications standards, and inspection requirements to identify an item or range of items.

NOTE: When you use an NSN to requisition an item, the item you receive may have a different part number from the part ordered, but go ahead and use or furnish it as the replacement part.

e. **DESCRIPTION AND USABLE ON CODE (UOC) (Column (5)).** This column includes the following information:

- (1) The Federal item name and, when required, a minimum description to identify the item.
- (2) The usable on code, when applicable (see paragraph 5, Special Information).

f. **QTY (Column (6)).** The QTY (quantity per figure column) indicates the quantity of the item used in the parts list which is prepared for a functional group, subfunctional group, or an assembly.

4. Explanation of Columns

a. NATIONAL STOCK NUMBER (NSN) INDEX

(1) **STOCK NUMBER column.** This column lists the NSN by National Item Identification Number (NIIN) sequence. The NIIN consists of the last nine digits of the NSN

NSN

(i.e., 5305-01-674-1467). When using this column to locate an item, ignore the first 4 digits of the NSN. However, the complete NSN
NIIN
should be used when ordering items by stock number.

(2) **FIG. column.** Indicates the figure number used to identify each item appearing in the listing. The figures are in numerical order in Section II.

(3) **ITEM column.** The item number identifies the item associated with the figure listed in the adjacent FIG. column. This item is also identified by the NSN listed on the same line.

b. **PART NUMBER INDEX.** Part numbers in this index are listed by part number in ascending alphanumeric sequence (i.e., vertical arrangement of letter and number combination which places the first letter or digit of each group in order A through Z, followed by the numbers 0 through 9 and each following letter or digit in like order).

(1) **FSCM column.** The Federal Supply Code for Manufacturer (FSCM) is a 5-digit numeric code used to identify the manufacturer, distributor, or Government agency, etc., that supplies the item.

(2) **PART NUMBER column.** Indicates the primary number used by the manufacturer (individual, firm, corporation, or Government activity), which controls the design and characteristics of the item by means of its engineering drawings, specifications standards, and inspection requirements to identify an item or range of items.

(3) **STOCK NUMBER column.** This column lists the NSN for the associated part number and manufacturer identified in the PART NUMBER and FSCM columns to the left. The part number line entry (with NSN, when available) identifies the first figure/item number appearance for which the part number is applicable. The part number is not listed for additional figure/item number appearances identified by that part number.

(4) **FIG. column.** This column lists the number of the figure where the item is located in Section II.

(5) **ITEM column.** The item number is that number assigned to the item as it appears in the figure referenced in the adjacent figure number column.

5. Special Information

a. Repair parts for components of standards sets which can be identified as existing in the supply system will be requisitioned through normal supply channels from the appropriate supply commodity manager.

b. Repair parts for components of standards sets which cannot be identified as to proper supply source will be requisitioned from USAMICOM, using routing identifier B64 and furnishing, as a minimum, the following as exception data.

(1) Component stock number of the individual end item to be repaired.

(2) Component manufacturer's equipment model number and serial number.

(3) The equipment manufacturer's stock number as listed in the appropriate manual for the desired repair part.

(4) The repair part reference designation, circuit reference, circuit symbol schematic designation, or reference number as listed in the manufacturer's manual.

(5) The technical specification of the repair part as contained in the appropriate manufacturer's manual.

(6) The title and date of the manufacturer's manual from which the information in a and b (3), (4), and (5) above was taken.

c. For requisitioning miscellaneous consumable maintenance supplies or expendable supplies, use CTA 50-970.

d. The usable on code appears in the lower left corner of the Description column heading. Usable on codes are shown as "UOC" in the Description column (justified left) on the first line applicable item description/nomenclature.

e. This RPSTL does not contain illustration for items listed in the Repair Parts List, since the manufacturer's manuals contain exploded view illustrations which are adequate for repair parts location. Copies of the manufacturer's manual (Tektronix Type 561 Series) are furnished with the equipment for which this RPSTL is prepared. The figure and item numbers in the listing are for locating the item within this RPSTL.

6. How to Locate Repair Parts

a. When National Stock Number or Part Number is Not Known.

(1) **First.** Refer to the parts list to locate the item by description. This list is listed in alphabetical sequence within each figure number.

(2) **Second.** After locating the item in the Repair Parts List, refer to the Part Number Index to find the NSN.

b. When National Stock Number or Part Number is Known.

(1) **First.** Using the Index of National Stock Numbers and Part Numbers, find the pertinent National Stock Number or Part Number. The NSN index is in National Item Identification Number (NIIN) sequence. The part numbers in the Part Number index are listed in ascending alphanumeric sequence.

Change 2 12-4

Both indexes cross-reference you to the illustration figure and item number of the item you are looking for.

(2) **Second.** After finding the figure and item number, verify that the item is the one you're looking for, then locate the item number in the repair parts list for the figure.

7. **Abbreviations.** Not applicable.

Change 2 12-5

SECTION II

TM 9-6625-963-14-1

(1) ITEM NO	(2) SMR CODE	(3) FSCM	(4) PART NUMBER	(5) DESCRIPTION AND USABLE ON CODES (UOC)	(6) QTY
GROUP 0010 - FIGURE 1 OSCILLOSCOPE 7910655-4 (19200)					
10	PAFZZ	80009	011-0052-00	ADAPTER.....	1
20	PAFZZ	80009	119-0013-00	BLOWER ASSEMBLY.....	1
30	PAFZZ	81349	CC30UJ101G	CAPACITOR, FIXED 500 V DC, 100 UUF,.....	1
				TYPE CC30UJ101G.....	
40	PAFZZ	81349	CK2ZAX1S1K	CAPACITOR, FIXED 500 V DC, 150 UUF,.....	1
				TYPE CK2ZAX151K (+- 10 0/0)	
50	PAFZZ	18876	10156805-1	CAPACITOR, FIXED 500 V DC, 1,000 UUF.....	1
60	XDFZZ	71590	DA049-145K	CAPACITOR, FIXED 500 V DC, 20,000.....	1
				UUF, (+ 80 0/0, - 20 0/0).....	
70	PAFZZ	37942	20-43851	CAPACITOR, FIXED 6.25 UF, 300 VDC.....	1
80	XDFZZ	81349	M39006/09-8513	CAPACITOR, FIXED 15 V DC, 100 UUF.....	1
90	XDFZZ	28480	0180-0244	CAPACITOR, FIXED.....	1
100	XDFZZ	56289	30D257G012DH4	CAPACITOR, FIXED 25 V DC, 100 UF.....	1
110	PAFZZ	56289	D27740	CAPACITOR, FIXED 30 V DC, 2,000 UF.....	2
120	PAFZZ	81349	CP05A1KE103K3	CAPACITOR, FIXED 400 V DC, 10,000.....	4
				UUF, TYPE CPO5A1KE103K3.....	
130	XDFZZ	80009	285-0519-C0	CAPACITOR, FIXED.....	1
140	PAFZZ	56289	5C023224X025C83	CAPACITOR, FIXED, CER 25 V DC, 220,.....	1
				000 UUF (+- 20 0/0).....	
150	PAFZZ	81349	6AU6WC	ELECTRON TUBE TYPE 6AU6WC.....	2
160	PAFZZ	81349	6DJ8	ELECTRON TUBE TYPE 6DJ8.....	1
170	PAFZZ	80131	6CZ5	ELECTRON TUBE TYPE 6CZ5.....	1
180	PAFZZ	81349	6080WC	ELECTRON TUBE TYPE 6C80WC.....	1
190	PAFZZ	80009	154-0613-00	ELECTRON TUBE.....	1
200	PAFZZ	81349	F02B250V3A	FUSE, CARTRIDGE 3 AMP, 125 V.....	1
210	PAFZZ	96906	MS25237-328	LAMP, INCANDESCENT 6 V, 0.2 AMP, 1C-6.....	1
				TUN-FIL, MIDGET FLGD BASE, T-1-3/4 BULB, CLEAR, WHITE LIGHT, 500 HR RATED LIFE, 5/8 LG.....	
220	PAFZZ	19200	7911844	MODIFICATION KIT.....	2
230	PAFZZ	96906	MS2508284	NUT, PLAIN, HEXAGON BR, CD-PLTD FIN., 1/4-28UNF-2B, 0.437 W ACROSS FLATS, 0.094 TH,.....	3
240	PAFZZ	96906	MS35649-245	NUT, PLAIN, HEXAGON.....	2
250	PAFZZ	96906	MS35649-2252	NUT, PLAIN, HEXAGON S, CD-PLTD W/ CHROMATE FIN., 1/4-20UNC-2B, 0.437 W/ ACROSS FLATS, 0.193 THK.....	3
260	PAFZZ	96906	MS535649-2382	NUT, PLAIN, HEXAGON S, CD-PLTD W/ CHROMATE FIN. 3/8-16UNC- 2B, 0.625 W ACROSS FLATS, 0.257 H.....	1
270	PAFZZ	96906	MS35649-242	NUT, PLAIN, HEXAGON S, CD-PLTD W/ CHROMATE FIN., NO. 4-4CUNC-2B, 1/4 W ACROSS FLATS, 0.098 THK.....	11
280	PAFZZ	96906	MS35649-262	NUT, PLAIN, HEXAGON S, CD-PLTD FIN., NO. 6-32UNC-2B, 0.312 W ACROSS FLATS, 0.114 H.....	17
290	PAFZZ	96906	MS35649-282	NUT, PLAIN, HEXAGON S, CD-PLTD W/	3

Change 2 12-6

SECTION II					
(1)	(2)	(3)	(4)	(5)	(6)
ITEM NO	SMR CODE	FSCM	PART NUMBER	DESCRIPTION AND USABLE ON CODES (UOC)	QTY
300	PAFZZ	96906	MS35649-202	CHROMATE FIN., NO. 8-32UNC-28, 0.344 W ACROSS FLATS, 0.13 H	4
310	PAFZZ	96906	MS35649-265	NUT, PLAIN, HEXAGON S, CD-PLTD W/ CHROMATE FIN., NO. 10-24UNC-2B, 0.375 W ACROSS FLATS, 0.13 H	17
320	PAFZZ	80009	017-0066-00	PROBE	1
330	XDFZZ	81349	RC42GF565J	RESISTOR, FIXED 2 W, 5.6 MEG HB5655 01121*	3
340	PAFZZ	81349	RCR20G470JS	RESISTOR, FIXED 1/2 W, 47 OHMS, TYPE RCR20G470JS (+- 5 0/0)	4
350	PAFZZ	81349	RCR20G101JS	RESISTOR, FIXED 1/2 W, 100 OHMS, TYPE RCR20G101JS (+- 5 0/0)	1
360	PAFZZ	81349	RCR20G151JS	RESISTOR, FIXED PORM 5 PCT	1
370	PAFZZ	81349	RCR20G221JS	RESISTOR, FIXED 1/2 W, 220 OHMS, TYPE RCR20GF221JS (+- 5 0/0)	1
380	PAFZZ	81349	RCR20G471JS	RESISTOR, FIXED 1/2 W, 470 OHMS, TYPE RCR20G471JS (+- 5 0/C)	3
390	PAFZZ	81349	RCR20G102JS	RESISTOR, FIXED 1/2 W, 1,000 OHMS, TYPE RCR20G102JS (+- 5 0/0)	7
400	PAFZZ	81349	RCR20G242JS	RESISTOR , FIXED 1/2 W, 2,400 OHMS, TYPE RCR20G242JS (+- 5 0/0)	1
410	PAFZZ	81349	RCR20G272JS	RESISTOR, FIXED 1/2 W, 2,700 OHMS, TYPE RCR20G272JS (+- 5 0/0)	2
420	PAFZZ	81349	RCR20G302JS	RESISTOR, FIXED 1/2 W, 3,000 OHMS, TYPE RCR20G302JS (+- 5 0/0)	1
430	PAFZZ	81349	RCR20G472JS	RESISTOR, FIXED 1/2 W, 4,700 OHMS, TYPE RCR20G472JS (+- 5 0/0)	1
440	PAFZZ	81349	RCR20G562JS	RESISTOR, FIXED 1/2 W, 5,600 OHMS, TYPE RCR20G562JS (+ - 5 0/0)	1
450	PAFZZ	81349	RCR20G103JS	RESISTOR, FIXED 1/2 W, 10,000 OHMS, TYPE RCR20G103JS (+- 5 0/0)	1
460	PAFZZ	81349	RCR20G153JS	RESISTOR, FIXED 1/2 W, 15,000 OHMS, TYPE RCR20G153JS (+- 5 0/0)	1
470	PAFZZ	81349	RCR20G183JS	RESISTOR, FIXED 1/2 W, 18,000 OHMS, TYPE RCR20G183JS (+- 5 0/0)	1
480	PAFZZ	81349	RCR20G223JS	RESISTOR, FIXED 1/2 W, 22,000 OHMS, TYPE RCR20G223JS (+- 5 0/0)	2
490	PAFZZ	81349	RCR20G273JS	RESISTOR ,FIXED 1/2 W, 27,000 OHMS, TYPE RCR20G273JS (+- 5 0/0)	2
500	PAFZZ	81349	RCR20G333JS	RESISTOR, FIXED 1/2 W, 33,000 OHMS, TYPE RCR20G333JS (+- 5 0/0)	2
510	PAFZZ	81349	RCR20G393JS	RESISTOR, FIXED 1/2 W, 39,000 OHMS, TYPE RCR20G393JS (+- 5 0/0)	1
520	PAFZZ	81349	RCR20G473JS	RESISTOR, FIXED 1/2 W, 47,000 OHMS, TYPE RCR20G473JS (+- 5 0/0)	2
530	PAFZZ	81349	RCR20G683JS	RESISTOR, FIXED 1/2 W, 68,000 OHMS, TYPE RCR20G683JS (+- 5 0/0)	1
540	PAFZZ	81349	RCR20G823JS	RESISTOR, FIXED 1/2 W, 82,000 OHMS, TYPE RCR20G823JS (+- 5 0/0)	3
550	PAFZZ	81349	RCR20G104JS	RESISTOR, FIXED 1/2 W, 100,000 OHMS,	6

Change 2 12-7

SECTION II					
(1)	(2)	(3)	(4)	(5)	(6)
ITEM NO	SMR CODE	FSCM	PART NUMBER	DESCRIPTION AND USABLE ON CODES (UOC)	QTY
560	PAFZZ	81349	RCR20G114JS	TYPE RCR20G104JS (+- 5 0/0) RESISTOR, FIXED PORM 5 PCT.....	1
570	PAFZZ	81349	RCR20G154JS	RESISTOR, FIXED 1/2 W, 150,000 OHMS, TYPE RCR20G154JS (+- 5 0/0).....	1
580	PAFZZ	81349	RCR20G184JS	RESISTOR, FIXED 1/2 W, 180,000 OHMS, TYPE RCR20G18JS (+- 5 0/0).....	1
590	PAFZZ	81349	RCR20G224JS	RESISTOR, FIXED 1/2 W, 220,000 OHMS, TYPE RCR20G224JS (+- 5 0/0).....	1
600	PAFZZ	81349	RCR20G474JS	RESISTOR, FIXED 1/2 W, 470,000 OHMS, TYPE RCR20G474JS (+- 5 0/0).....	2
610	PAFZZ	81349	RCR20G564JS	RESISTOR, FIXED 1/2 W, 560,000 OHMS, TYPE RCR20G564JS (+- 5 0/0).....	3
620	PAFZZ	81349	RCR20G684JS	RESISTOR, FIXED 1/2 W, 680,000 OHMS, TYPE RC20GF684J (+- 5 0/0).....	1
630	PAFZZ	81349	RCR20G125JS	RESISTOR, FIXED 1/2 W, 1.2 MEG, TYPE RCR20G125JS (+- 5 0/0).....	1
640	PAFZZ	81349	RCR20G106JS	RESISTOR FIXED 1/2 W, 10 MEG, TYPE RCR20G106JS (+ - 5 0/0).....	2
650	PAFZZ	81349	RCR32G100JS	RESISTOR, FIXED 1 W, 10 OHMS, TYPE RCR32G100JS (+- 5 0/0).....	3
660	XDFZZ	81349	RC32GF224J	RESISTOR, FIXED 1 W, 220,000 OHMS, TYPE RC32GF224J (+- 5 0/0).....	1
670	PAFZZ	81349	RC42GF681J	RESISTOR, FIXED 2 W, 680 OHMS, TYPE RC42GF681J (+- 5 0/0).....	1
680	XDFZZ	81349	RC42GF395J	RESISTOR, FIXED 2 W, 3.9 MEG, TYPE RC42GF395J (+- 5 0/0).....	3
690	PAFZZ	81349	RCR32G563JS	RESISTOR, FIXED 1 W, 56,000 OHMS, TYPE RCR32G563JS (+- 5 0/0).....	1
700	XDFZZ	81349	RC42GF685J	RESISTOR, FIXED 2 W, 6.8 MEG, TYPE RC42GF685J (+- 5 0/0).....	2
710	PAFZZ	81349	RCR42G223JS	RESISTOR, FIXED, COMP 2 W, 22,000 OHMS (+- 5 0/0).....	1
720	XDFZZ	81349	RN65F1800D	RESISTOR, FIXED, FILM.....	2
730	XDFZZ	81349	RN65D20R0F	RESISTOR, FIXED, FILM 1/2 W, 20 OHMS, TYPE RN65D20R0F (+- 1/2 0/0).....	2
740	PAFZZ	81349	RN65F2490D	RESISTOR, FIXED, FILM 1/2 W, 49 OHMS, TYPE RN65F2490D (+- 1/2 0/0).....	1
750	PAFZZ	81349	RN65F1F801D	RESISTOR, FIXED, FILM 1/2 W, 1,800 OHMS, TYPE RN65F1801D (+- 1/2 0/0).....	2
760	PAFZZ	81349	RN65D2051F	RESISTOR , FIXED, FILM 1/2 W, 2,050 OHMS, TYPE RN65D2051F (+- 1 0/0).....	1
770	PAFZZ	81349	RN65F3323F	RESISTOR, FIXED, FILM 1/2 W, 330,000 OHMS (+- 1 0/0).....	1
780	PAFZZ	81349	RBR54L10001BR	RESISTOR, FIXED, WIRE 1/4 W, 10,000 OHMS (+- 1 0/0).....	1
790	PAFZZ	80009	308-0090-00	RESISTOR, FIXED, WIRE 1 W, 1/4 OHMS (+- 1 0/0).....	1
800	XDFZZ	81349	RB58CE79601D	RESISTOR, FIXED, WIRE 1 W, 79,600 OHMS, TYPE RB58CE79601D (+- .5 0/0).....	1
810	PAFZZ	81349	RW69V300	RESISTOR, FIXED, WIRE 3 W,30 OHMS, TYPE RW69V300 (+- 5 0/0).....	1

Change 2 12-8

SECTION II

(1) ITEM NO	(2) SMR CODE	(3) FSCM	(4) PART NUMBER	(5) DESCRIPTION AND USABLE ON CODES (UOC)	(6) QTY
820	PAFZZ	80009	308-0176-00	RESISTOR, FIXED, WIRE 20 W, 4,000 OHMS (+ 5 0/0)	1
830	PAFZZ	81349	RA20NASD103A	RESISTOR, VARIABLE 10,000 OHMS	1
840	PAFZZ	80009	311-0206-00	RESISTOR, VARIABLE 250,000 OHMS (+20 0/0).....	1
850	PAFZZ	80009	311-0068-00	RESISTOR, VARIABLE	3
860	PAFZZ	12697	CM30944	RESISTOR, VARIABLE 50 OHMS	1
870	PAFZZ	18876	1093878-002	RESISTOR, VARIABLE COMPOSITION ELEMENT, 1 SEC, 0.2 W, 2 MEG (+ 20 0/0)	1
880	PAFZZ	81349	RV4NAYSD104A	RESISTOR, VARIABLE COMPOSITION ELEMENT, 2 W, 100,000 OHMS, TYPE RV4NAYSD104A (+ 10 0/0)	1
890	PAFZZ	80009	311-0254-00	RESISTOR, VARIABLE 2 W, 5 MEG	1
900	PAFZZ	01121	JJ38270D	RESISTOR, VARIABLE, N	1
910	PAFZZ	96906	MS16998-33	SCREW, CAP, SOCKET ALLOY-S, CD-PLTD FIN., NO. 10-32UNF-3A X 1-1/2	4
920	PAFZZ	96906	MS16997-23	SCREW, CAP, SOCKET FL-FIL-HD, S, CD- PLTD W/CHROMATE FIN., NO. 6-32UNC-3A X 7/8	2
930	PAFZZ	96906	MS35214-13	SCREW, MACHINE CROSS-RECESS-PAN-HD, BR, BLK-OXIDE FIN., NO. 4-40NC-2A X 5/16	3
940	PAFZZ	96906	MS51957-79	SCREW, MACHINE CROSS-RECESS-PAN-HD, CORR-RES-S, PASS-FIN., 1/4-20UNC-2A X 1/2	4
950	PAFZZ	96906	MS51957-27	SCREW, MACHINE CROSS-RECESS-PAN-HD, CORR-RES-S, PASS-FIN., NO. 6-32UNC-2A X 5/16	9
960	PAFZZ	96906	MS35206-227	SCREW, MACHINE CROSS-RECESS-PAN-HD, S, CD-PLTD W/CHROMATE FIN., NO. 6-32UNC-2A X 5/6	6
970	PAFZZ	96906	MS35206-228	SCREW, MACHINE CROSS-RECESS-PAN-HD, S, CD-PLTD W/CHROMATE FIN., NO. 6- 32UNC-2A X 0.375	4
980	PAFZZ	96906	MS35206-235	SCREW, MACHINE CROSS-RECESS-PAN-HD, S, CD-PLTD W/CHROMATE FIN., NO. 6-32UNC-2A X 1-1/4	1
990	PAFZZ	96906	MS24693S48	SCREW, MACHINE CROSS RECESS FL-CK- HD, S, CD-PLTD W/CHROMATE FIN., NO. 8-32NC-2A X 3/8	10
1000	PAHZZ	96906	MS24693S26	SCREW, MACHINE CROSS RECESS FL-CK- HD, S, CD-PLTD W/CHROMATE FIN., NO. 6- 32UNC-2A X 0.375	2
1010	PAFZZ	96906	MS35206-247	SCREW, MACHINE CROSS-RECESS-PAN-HD, S, CD-PLTD W/CHROMATE FIN., NO. 8-32NC-2A X 3/4	6
1020	PAFZZ	96906	MS51957-15	SCREW, MACHINE CROSS-RECESS-PAN-HD, CORR-RES-S, PASS-F IN., NO. 4-40UNC-2A X 3/8	2
1030	PAHZZ	96906	MS51957-17	SCREW, MACHINE CROSS-RECESS-PAN-HD, CORR-RES-S, PASS-F IN., NO. 4-40UNC-2A X 1/2	4

Change 2 12-9

SECTION II

(1) ITEM NO	(2) SMR CODE	(3) FSCM	(4) PART NUMBER	(5) DESCRIPTION AND USABLE ON CODES (UOC)	(6) QTY
1040	PAFZZ	96906	MS51957-25	SCREW, MACHINE CROSS-RECESS-PAN-HD, CORR-RES-S, PASS-FIN. , NO. 6-32UNC-2A X 3/16	2
1050	PAFZZ	96906	MS51957-26	SCREW, MACHINE CROSS-RECESS-PAN-HD, CORR-RES-S, PASS-FIN. ,NO. 6-32NC-2A X 1/4	8
1060	PAFZZ	96906	MS51957-28	SCREW, MACHINE CROSS-RECESS-PAN-HD, CORR-RES-S, PASS-FIN. , NO. 6-32UNC-2A X 3/8	3
1070	PAFZZ	96906	MS51957-32	SCREW, MACHINE CROSS-RECESS-PAN-HD, CORR-RES-S, PASS-FIN. NO. 6-32UNC-2A X 3/4	4
1080	PAFZZ	96906	MS51957-42	SCREW, MACHINE CROSS-RECESS-PAN-HD, CORR-RES-S, PASS-FIN. NO. 8-32UNC-2A X 5/16	3
1090	PAFZZ	96906	MS51957-52	SCREW, MACHINE CROSS-RECESS-PAN-HD, CORR-RES-S, PASS-FIN. , NO. 8-32UNC-2A X 1-3/4	3
1100	PAFZZ	96906	MS51958-63	SCREW, MACHINE CROSS-RECESS-PAN-HD, CORR-RES-S, PASS-FIN. , NO. 10-32UNF-2A X 1/2	2
1110	PAFZZ	96906	MS35206-226	SCREW, MACHINE CROSS-RECESS-PAN-HD, 40 S, CD-PLTD W/CHROMATE FIN., NO. 6-32UNC-2A X 1/4	40
1120	PAFZZ	96906	MS35206-242	SCREW, MACHINE CROSS-RECESS-PAN-HD, S, CD-PLTD W/CHROMATE FIN., NO. 8-32NC-2A X 0.312.....	41
1130	PAFZZ	96906	MS24693S25	SCREW, MACHINE FL-CK-HD, S, CD-PLTD W/ CHROMATE FIN., NO. 6-32NC-2A X 03125	14
1140	PAFZZ	96906	MS24693S24	SCREW, MACHINE FL-CK-HODS, CD-PLTD W/ CHROMATE FIN., NO. 6-32NC-2A X 0.25	4
1150	PAFZZ	96906	MS51959-42	SCREW, MACHINE HEX-HD, CORR-RES-S, PASS-FIN., NO. 8-32UNC-2A X .313	23
1160	XDFZZ	96906	MS51861-40	SCREW TAPPING ,THREA	4
1165	PAFZZ	96906	MS24629-4	SCREW, TAPPING CROSS-RECESS-PAN-HD, S, CD-PLTD W/CHROMATE FIN., NO. 2-56 X 5/16	6
1170	PAFZZ	96906	MS24629-20	SCREW, TAPPING CROSS-RECESS-PAN-HD, S, CD-PLTD W/CHROMATE FIN., NO. 6-32 X 0.1875	8
1180	PAFZZ	81349	JAN1N540	SEMICONDUCTOR TYPE 1N540	12
1190	PAFZZ	96906	MS51965-17	SETSCREW	1
1200	PAFZZ	96906	MS51963-33	SETSCREW HDLS, FL-PT , SCD-PLTD W/ CHROMATE FIN. ,NO. 8-32NC-3A X 1/8 NON-IDENTICAL, DATED 8 MAR 72, SEE FSN 5305-719-5336, REF NO. MS51963-33 #	2
1210	PAFZZ	80009	260-0449-00	SWITCH, SLIDE	1
1220	PAFZZ	04713	SP1820	TRANSISTOR TYPE 2N3614	1
1230	PAFZZ	81349	JAN2N1302	TRANSISTOR GERMANIUM , HERMETICALLY SEALED, 0.37 X 0.26, W/3 WIRE LEAD TYPE TERM.....	1

Change 2 12-10

SECTION II

(1) ITEM NO	(2) SMR CODE	(3) FSCM	(4) PART NUMBER	(5) DESCRIPTION AND USABLE ON CODES (UOC)	(6) QTY
1240	PAFZZ	81349	JAN2N1131	TRANSISTOR TYPE JAN2N1131	1
1250	PAFZZ	80131	2N1378	TRANSISTOR.....	1
1260	PAFZZ	80009	151-0005-00	TRANSISTOR TYPE 2N1302.....	1
1270	PAFZZ	96906	MS15795-413	WASHER, FLAT	1
1280	PAFZZ	88044	AN960-3	WASHER, FLAT CARB-S, CD-PLTD FIN 0.109 ID, 0.25 OD, 0.032 THK.....	2
1290	PAFZZ	18876	8193544	WASHER, FLAT	3
1300	PAFZZ	96906	MS15795-913	WASHER, FLAT BR, BLK OXIDE FIN., 0.375 ID, 0.875 OD, 0.104 THK.....	2
1310	XDFZZ	96906	MS45901-8	WASHER, FLAT BR, TN OR SIL-PLTD FN., 0.515 ID, 0.875 OD, 0.064 THK.....	2
1320	PAFZZ	88044	AN960-616	WASHER, FLAT CARB-S, CD-PLTD FIN., 0.39 ID, 5/8 OD, 0.064 THK.....	4
1330	PAFZZ	96906	MS15795-803	WASHER, FLAT CORR-RES-S, PASS-FIN., 0.125 ID, 0.25 OD, 0.022 THK.....	4
1340	PAFZZ	96906	MS15795-414	WASHER, FLAT NI-COP. ALLOY, 3/8 BOLT SIZE .0812 OD, 0.08 THK	1
1350	PAFZZ	80205	NAS155M3L	WASHER, FLAT PLASTIC, 0.203 ID 0.438 OD, 0.031 THK	2
1360	PAFZZ	88044	AN960-416	WASHER, FLAT S, CD-PLTD FIN., 17/64 ID, 1/2 OD, 1/16 THK.....	2
1370	PAFZZ	88044	AN960-10	WASHER, FLAT S, CD-PLTD FIN., 13/64 ID, 7/16 OD, 0.063 THK.....	2
1380	PAFZZ	96906	MS35333-77	WASHER, LOCK CORR-RES-S, PASS-FIN., 0.789 ID, 0.789 OD, 0.04 THK.....	1
1390	PAFZZ	96906	MS35333-76	WASHER, LOCK INT-TEETH, CORR-RES-S, PASS-FIN., 0.398 ID, 0.692 OD, 0.04 THK	4
1400	PAFZZ	96906	MS35333-70	WASHER, LOCK INT-TEETH, CORR-RES-S, PASS-FIN., 0.123 ID, 0.27 OD, 0.019 THK	7
1410	PAFZZ	96906	MS35333-71	WASHER, LOCK INT-TEETH, CORR-RES-S, PASS-FIN., 0.15 ID, 0.295 OD, 0.021 THK	13
1420	PAFZZ	96906	MS35333-36	WASHER, LOCK INT-TEETH, S, CD-PLTD W/ CHROMATE FIN., 0.112 ID, 0.27 OD, 0.018 THK.....	2
1430	PAFZZ	96906	MS35333-37	WASHER, LOCK INT-TEETH, S, CD-PLTD W/ CHROMATE FIN., 0.15 ID, 0.295 OD, 0.021 THK	5

Change 2 12-11

NATIONAL STOCK NUMBER AND PART NUMBER INDEX

NATIONAL STOCK NUMBER INDEX					
STOCK NUMBER	FIG.	ITEM	STOCK NUMBER	FIG.	ITEM
5310-00-045-5213	1	1300	5905-00-141-1116	1	440
5905-00-050-2422	1	900	5905-00-141-1130	1	410
5305-00-051-6521	1	1130	5310-00-141-1795	1	1360
5305-00-052-6908	1	1165	6240-00-155-7857	1	210
5305-00-054-5649	1	1020	5960-00-156-4954	1	190
5305-00-054-5651	1	1030	5310-00-167-0657	1	1280
5305-00-054-6649	1	1040	5310-00-167-0818	1	1370
5305-00-054-6650	1	1050	5310-00-167-0821	1	1320
5305-00-054-6651	1	950	5905-00-177-7434	1	780
5305-00-054-6652	1	1060	5960-00-179-3252	1	180
5305-00-054-6656	1	1070	5960-00-179-3710	1	150
5305-00-054-6667	1	1080	5310-00-180-0277	1	1390
5305-00-054-6677	1	1090	5310-00-193-7577	1	1420
5905-00-055-7942	1	870	4931-00-193-8226	1	220
5310-00-056-3395	1	260	5305-00-207-7466	1	930
5305-00-059-3659	1	1100	5905-00-247-8735	1	690
5305-00-071-1315	1	940	5905-00-256-0390	1	670
5910-00-081-0587	1	140	5310-00-264-1340	1	1380
5961-00-081-8365	1	1240	5310-00-264-1389	1	1290
5305-00-087-2070	1	1170	4931-00-404-7389	1	10
5905-00-104-8330	1	500	4140-00-409-9252	1	20
5905-00-104-8333	1	580	4931-00-410-5786	1	320
5905-00-104-8336	1	550	5905-00-459-5427	1	820
5905-00-104-8343	1	650	5310-00-550-3715	1	1400
5905-00-104-8350	1	370	5910-00-577-1269	1	70
5905-00-106-1273	1	460	5310-00-579-0079	1	1430
5905-00-106-1282	1	480	5310-00-595-6211	1	1330
5905-00-106-9344	1	350	5910-00-615-0105	1	30
5905-00-106-9345	1	530	5310-00-616-3555	1	1410
5905-00-106-9348	1	570	5310-00-616-6750	1	1340
5905-00-106-9351	1	490	5905-00-617-8016	1	830
5905-00-108-6922	1	360	5905-00-644-6693	1	880
5905-00-110-0196	1	390	5310-00-655-9477	1	1270
5905-00-111-4732	1	630	5310-00-717-5584	1	1350
5905-00-111-4734	1	340	5305-00-719-5336	1	1200
5905-00-111-4741	1	400	5305-00-724-6740	1	1190
5905-00-111-4858	1	380	5905-00-725-9141	1	790
5905-00-114-5393	1	590	5905-00-729-0051	1	850
5905-00-114-5417	1	420	5305-00-765-4252	1	1150
5905-00-114-5456	1	620	5960-00-800-0548	1	170
5905-00-114-5489	1	540	5910-00-821-4702	1	120
5905-00-116-8557	1	560	5310-00-822-0077	1	230
5905-00-121-9859	1	640	5961-00-824-3777	1	1220
5905-00-140-6155	1	710	5961-00-850-7646	1	1230
5905-00-141-0591	1	450	5960-00-880-0457	1	160
5905-00-141-0595	1	430	5305-00-889-3002	1	1120
5905-00-141-0596	1	520	5961-00-891-7440	1	1260
5905-00-141-0599	1	510	5910-00-916-3648	1	50
5905-00-141-1071	1	600	5905-00-917-0235	1	750
5905-00-141-1073	1	610	5905-00-918-2272	1	860

Change 2 12-12

NATIONAL STOCK NUMBER AND PART NUMBER INDEX

		NATIONAL STOCK NUMBER INDEX			
STOCK NUMBER	FIG.	ITEM	STOCK NUMBER	FIG.	ITEM
5905-00-919-5886	1	740			
5310-00-934-9739	1	270			
5310-00-934-9746	1	240			
5310-00-934-9747	1	280			
5310-00-934-9757	1	290			
5310-00-934-9758	1	300			
5310-00-934-9763	1	310			
5910-00-935-3401	1	40			
5905-00-935-8545	1	470			
5930-00-937-0871	1	1210			
5910-00-954-1773	1	110			
5305-00-957-7814	1	990			
5305-00-957-7816	1	1140			
5305-00-957-7817	1	1000			
5905-00-968-0112	1	890			
5961-00-978-7660	1	1180			
5305-00-978-9351	1	920			
5905-00-980-8811	i	840			
5905-00-982-3336	1	810			
5905-00-983-5954	1	770			
5305-00-983-7430	1	910			
5961-00-984-0059	1	1250			
5305-00-984-4983	1	1110			
5305-00-984-4984	1	960			
5305-00-984-4988	1	970			
5305-00-984-6195	1	1010			
5305-00-984-6222	1	980			
5905-00-990-4915	1	760			
5310-00-997-1888	1	250			
5920-01-028-5727	1	200			

Change 2 12-13

NATIONAL STOCK NUMBER AND PART NUMBER INDEX

FSCM	PART NUMBER	PART NUMBER INDEX		FIG.	ITEM
			STOCK NUMBER		
88044	AN960-10		5310-00-167-0818	1	1370
88044	AN960-3		5310-00-167-0657	1	1280
88044	AN960-416		5310-00-141-1795	1	1360
88044	AN960-616		5310-00-167-0821	1	1320
81349	CC30UJ101G		5910-00-615-0105	1	30
81349	CK22AX151K		5910-00-935-3401	1	40
12697	CM30944		5905-00-918-2272	1	860
81349	CP05A1KE103K3		5910-00-821-4702	1	120
71590	DA049-145K			1	60
56289	D27740		5910-00-954-1773	1	110
81349	F02B250V3A		5920-01-028-5727	1	200
81349	JAN1N540		5610-00-978-7660	1	1180
81349	JAN2N1131		5961-00-081-8365	1	1240
81349	JAN2N1302		5961-00-850-7646	1	1230
01121	JJ38270D		5905-00-050-2422	1	900
96906	MS15795-413		5310-00-655-9477	1	1270
96906	MS15795-414		5310-00-616-6750	1	1340
96906	MS15795-803		5310-00-595-6211	1	L330
96906	MS15795-913		5310-00-045-5213	1	1300
96906	MS16997-23		5305-00-978-9351	1	920
96906	MS16998-33		5305-00-983-7430	1	910
96906	MS24629-20		5305-00-087-2070	1	170
96906	MS24629-4		5305-00-052-6908	1	1165
96906	MS24693S24		5305-00-957-7816	1	140
96906	MS24693S25		5305-00-051-6521	1	1130
96906	MS24693S26		5305-00-957-7817	1	1000
96906	MS24693S48		5305-00-957-7814	1	990
96906	MS25082B4		5310-00-822-0077	1	230
96906	MS25237-328		6240-00-155-7857	1	210
96906	MS35206-226		5305-00-984-4983	1	1110
96906	MS35206-227		5305-00-984-4984	1	960
96906	MS35206-228		5305-00-984-4988	1	970
96906	MS35206-235		5305-00-984-6222	1	980
96906	MS35206-242		5305-00-889-3002	1	1120
96906	MS35206-247		5305-00-984-6195	1	1010
96906	MS35214-13		5305-00-207-7466	1	930
96906	MS35333-36		5310-00-193-7577	1	1420
96906	MS35333-37		5310-00-579-0079	1	1430
96906	MS35333-70		5310-00-550-3715	1	1400
96906	MS35333-71		5310-00-616-3555	1	1410
96906	MS35333-76		5310-00-180-0277	1	1390
96906	MS35333-77		5310-00-264-1340	1	1380
96906	MS35649-202		5310-00-934-9758	1	300
96906	MS35649-2252		5310-00-997-1888	1	250
96906	MS35649-2382		5310-00-056-3395	1	260
96906	MS35649-242		5310-00-934-9739	1	270
96906	MS35649-245		5310-00-934-9746	1	240
96906	MS35649-262		5310-00-934-9747	1	280
96906	MS35649-265		5310-00-934-9763	1	310
96906	MS35649-282		5310-00-934-9757	1	290
96906	MS45901-8			1	1310

Change 2 12-14

NATIONAL STOCK NUMBER AND PART NUMBER INDEX

FSCM	PART NUMBER	PART NUMBER INDEX		FIG.	ITEM
			STOCK NUMBER		
96906	MS51861-4C			1	1160
96906	MS51957-15		5305-00-054-5649	1	1020
96906	MS51957-17		5305-00-054-5651	1	1030
96906	MS51957-25		5305-00-054-6649	1	1040
96906	MS51957-26		5305-00-054-6650	1	1050
96906	MS51957-27		5305-00-054-6651	1	950
96906	MS51957-28		5305-00-054-6652	1	1060
96906	MS51957-32		5305-00-054-6656	1	1070
96906	MS51957-42		5305-00-054-6667	1	1080
96906	MS51957-52		5305-00-054-6677	1	1090
96906	MS51957-79		5305-00-071-1315	1	940
96906	MS51958-63		5305-00-059-3659	1	1100
96906	MS51959-42		5305-00-765-4252	1	150
96906	MS51963-33		5305-00-719-5336	1	1200
96906	MS51965-17		5305-00-724-6740	1	1190
81349	M39006/09-8513			1	80
80205	NAS1515M3L		5310-00-717-5584	1	1350
81349	RA20NASD103A		5905-00-617-8016	1	830
81349	RBR54L10001BR		5905-00-177-7434	1	780
81349	RB58CE79601D			1	800
81349	RCR20G101JS		5905-00-106-9344	1	350
81349	RCR20G102JS		5905-00-110-0196	1	390
81349	RCR20G103JS		5905-00-141-0591	1	450
81349	RCR20G104JS		5905-00-104-8336	1	550
81349	RCR20G106JS		5905-00-121-9859	1	640
81349	RCR20G114JS		5905-00-116-8557	1	560
81349	RCR20G125JS		5905-00-111-4732	1	630
81349	RCR20G151JS		5905-00-108-6922	1	360
81349	RCR20G153JS		5905-00-106-1273	1	460
81349	RCR20G154JS		5905-00-106-9348	1	570
81349	RCR20G183JS		5905-00-935-8545	1	470
81349	RCR20G184JS		5905-00-104-8333	1	580
81349	RCR20G221JS		5905-00-104-8350	1	370
81349	RCR20G223JS		5905-00-106-1282	1	480
81349	RCR20G224JS		5905-00-114-5393	1	590
81349	RCR20G242JS		5905-00-111-4741	1	400
81349	RCR20G272JS		5905-00-141-1130	1	410
81349	RCR20G273JS		5905-00-106-9351	1	490
81349	RCR20G302JS		5905-00-114-5417	1	420
81349	RCR20G333JS		5905-00-104-8330	1	500
81349	RCR20G393JS		5905-00-141-0599	1	510
81349	RCR20G470JS		5905-00-111-4734	1	340
81349	RCR20G471JS		5905-00-111-4858	1	380
81349	RCR20G472JS		5905-00-141-0595	1	430
81349	RCR20G473JS		5905-00-141-0596	1	520
81349	RCR20G474JS		5905-00-141-1071	1	600
81349	RCR20G562JS		5905-00-141-1116	1	440
81349	RCR20G564JS		5905-00-141-1073	1	610
81349	RCR20G683JS		5905-00-106-9345	1	530
81349	RCR20G684JS		5905-00-114-5456	1	620
81349	RCR20G823JS		5905-00-114-5489	1	540

Change 2 12-15

NATIONAL STOCK NUMBER AND PART NUMBER INDEX

FSCM	PART NUMBER	PART NUMBER INDEX		FIG.	ITEM
			STOCK NUMBER		
81349	RCR32G100JS		5905-00-104-8343	1	650
81349	RCR32G563JS		5905-00-247-8735	1	690
81349	RCR42G223JS		5905-00-140-6155	1	710
81349	RC32GF224J			1	660
81349	RC42GF395J			1	680
81349	RC42GF565J			1	330
81349	RC42GF681J		5905-00-256-0390	1	670
81349	RC42GF685J			1	700
81349	RN65020R0F			1	730
81349	RN65D2051F		5905-00-990-4915	1	760
81349	RN65F1800D			1	720
81349	RN65F1801D		5905-00-917-0235	1	750
81349	RN65F2490D		5905-00-919-5886	1	740
81349	RN65F3323F		5905-00-983-5954	1	770
81349	RV4NAYS104A		5905-00-644-6693	1	880
81349	RW69V300		5905-00-982-3336	1	810
04713	SP1820		5961-00-824-3777	1	1220
80009	011-0052-00		4931-00-404-7389	1	10
80009	017-0066-00		4931-00-410-5786	1	320
28480	0180-0244			1	90
18876	10156805-1		5910-00-916-3648	1	50
18876	10193878-002		5905-00-055-7942	1	870
80009	119-0013-00		4140-00-409-9252	1	20
80009	151-0005-00		5961-00-891-7440	1	1260
80009	154-0613-00		5960-00-156-4954	1	190
8013	2N1378		5961-00-984-0059	1	1250
37942	20-43851		5910-00-577-1269	1	70
80009	260-0449-00		5930-00-937-0871	1	1210
80009	285-0519-00			1	130
56289	30D257G012DH4			1	100
80009	308-0090-00		5905-00-725-9141	1	790
80009	308-0176-00		5905-00-459-5427	1	820
80009	311-0068-00		5905-00-729-0051	1	850
80009	311-0206-00		5905-00-980-8811	1	840
80009	311-0254-00		5905-00-968-0112	1	890
56289	5C023224X0250B3		5910-00-081-0587	1	140
81349	6AU6WC		5960-00-179-3710	1	150
80131	6CZ5		5960-00-800-0548	1	170
81349	6DJ8		5960-00-880-0457	1	160
81349	6080WC		5960-00-179-3252	1	180
19200	7911844		4931-00-193-8226	1	220
18876	8193544		5310-00-264-1389	1	1290

* U. S. GOVERNMENT PRINTING OFFICE: 1986 637-871/40149

PIN 027977 002

Change 2 12-16

APPENDIX A

REFERENCES

Following is a list of publications available to the Graphical Display System, Tektronix Type 561 Series operator and maintenance personnel.

DA Pam 310-4	Military Publications: Index of Technical Manuals, Technical Bulletins, Supply Manuals types 7, 8, and 9), Supply Bulletins, and Lubrications Orders.
DA Pam 310-7	Military Publications: U. S. Army Equipment Index of Modification Work Orders.
TM 38-750	The Army Maintenance Management System (TAMMS).
SB 38-100	Preservation, Packaging, Packing, and Marking Materials, Supplies, and Equipment used by the Army.
TB 746-10	Field Instruction for Painting and Preserving Electronics Command Equipment.
TB 750-236	Calibration Requirements for the Maintenance of Army Materiel.

APPENDIX B

BASIC ISSUE ITEMS LIST AND ITEMS TROOP INSTALLED

OR AUTHORIZED LIST

Section I. INTRODUCTION

B-1 Scope

This manual lists basic issue items and troop installed or authorized items which accompany the Graphical Display System, Tektronix Type 561 Series and are required for installation, operation, or maintenance.

authorized list is divided into the following sections:

a. *Basic Issue Items-Section II.* A list of items which accompany the Graphical Display System, Tektronix Type 561 Series and are required by the operator/crew for installation, operation, or maintenance.

b. *Items Troop Installed or Authorized List-Section III.* Not applicable.

B-2 General

This basic issue items list and items troop installed or

Section II. BASIC ISSUE ITEMS LIST FOR 561 SERIES

B-3 TYPE RM561A

Description	Qty Furn. W/Equip	Serial No.		Mfr. Part No.
		Eff.	Disc.	
CORD, power	1	5001	7499	161-0013-00
CORD, power	1	7500	8829	161-0022-00
CORD, power	1	8830	9819	161-0024-00
CORD, power	1	8830	11589	161-0024-00
CORD, power	1	11590		161-0024-01
ADAPTER, 3- to 2-wire	1			103-0013-00
FILTER, green	1	5001	6885	378-0534-00
FILTER, smoke gray (installed)	1	8608		378-0560-00
PLATE, protector	1	X6886		387-0935-00
CORD, patch	1	X6200	7978	012-0031-00
CORD, patch	1	7979		012-0087-00
CORD, patch	1	X7979		012-0092-00
JACK, BNC-post	1	X7979		012-0092-00
ADAPTER, BNC to binding post	2	X5280	X7978X	103-0033-00
SCREW, 10-32x1/2 OHS	4			212-0512-00
SCREW, 12-24x1/4 OHS	4			212-0561-00
WASHER, Teflon	4			210-0833-00
WASHER, steel, finishing No. 10	4			210-0917-00

B-4 TYPE R561B

Description	Qty Furn. W/Equip	Serial No.		Mfr. Part No.
		Eff.	Disc.	
CORD, patch	1			012-0087-00
JACK, BNC-post	1			012-0092-00
HARDWARE KIT	1			016-0131-00

APPENDIX C

MAINTENANCE ALLOCATION CHART

MAINTENANCE ALLOCATION CHART,

This maintenance allocation chart designates overall responsibility for the performance of maintenance functions on the identified end item or component. The implementation of field maintenance task support upon this end item or component will be consistent with the assigned maintenance operations which are-defined as follows:

	<i>Operation</i>	<i>Definition</i>
Depot		That level of logistics which has the facilities, personnel, and capabilities to equal the quality of the equipment repair available at the contractor's facilities (D).
Reference		That level in the maintenance of calibration equipment which provides DS and GS logistical support (H).
Transfer		That level in the maintenance of calibration equipment which provides organizational and limited DS logistical support to secondary transfer equipment (F).

Oscilloscope, 7910655-2

MAC

Group number	Functional group	Maintenance functions												
		a	b	c	d	e	f	g	h	i	j	k	l	m
		Inspect	Test	Service	Adjust	Align	Calibrate	Install	Repalce	Repair	Overhaul	Rebuild	Tool reqd.	Remarks
1	Oscilloscope, Type TM561A	F	F	F			F	F	F	F	D		1	A
2	Switch, Calibrate, Wired	F							F	F	D		2	B
3	Shield, CRT	F							F	F	D		3	C
4	Chassis, front Assembly	F							F	F	D		4	D
5	Chassis, Rear Assembly	F							F	F	D		4	D

Oscilloscope, 79110655-2

Tools Required

Tool code	Category	Nomenclature	Tool number
1-b	F	Transformer, Variable Power 7910809	6120-054-7794
	F	Amplifier, Plug-In, Unit, Dual Trace 7911441-1	4931-913-2979
	F	Plug-In Unit, Electrical Time Base 7911437-1	6625-247-4461
	F	Voltage Kilovoltmeter, DC 8616326	6625-580-7731
	F	Oscilloscope 7910655-2	6625-936-1313
	F	Preamplifier, DC 7910993	4931-959-6727
	F	Voltmeter/Ratiometer, Digital 7910588-3	4931-913-3069
	F	Adapter, Connector 7907560	4931-739-4420
	F	Adapter, Connector 7909401	5935-992-6112

Tool code	Category	Nomenclature	Tool number
	F	Adapter, Connector 10519439	6625-953-3214
	F	Cable Assembly, RF 7909410	4931-072-0780
	F	Cable Assembly, RF 7907467	4931-843-2792
	F	Lead, Electrical 7907497	4931-739-4432
	F	Lead, Electrical 7907498	4931-739-4433
1-c	F	Cleaner, Electrical Contact	6850-973-3122
	F	Brush, Artist	8020-224-8022
		Brush, Dusting	7920-685-3980
		Clean Soft Cloth	7920-205-3571
1-f	F	Auto-transformer 7910809	6120-054-7794
	F	Amplifier Plug-In Unit, Dual Trace 7911441-1	4931-913-2979
	F	Plug-In Unit, Electrical, Time Base 7911437-1	6625-247-4461
	F	Voltmeter, Kilovoltmeter, DC 8616326	6625-580-7731
	F	Oscilloscope 7910655-2	6625-935-1313
	F	Preamplifier, DC 7910993	4931-959-6727
	F	Voltmeter, Ratiometer Digital 7916588-3	4931-959-6727
	F	Adapter, Connector 7907560	4931-739-4420
	F	Adapter, Connector 7909401	5935-992-6112
	F	Adapter, Connector 10519439	6625-953-3214
	F	Cable Assembly, RF 7909410	4931-072-0780
	F	Cable Assembly, RF 7907467	4931-843-2792
	F	Lead, Electrical 7907497	4931-739-4432
	F	Lead, Electrical 7907498	4931-739-4433
	F	Tool Kit, Alignment	5180-650-7823
1-9	F	Tool Kit	5819-650-7821
1-h	F	Tool Kit	5180-650-7821
1-h	F	Tool Kit	5180-650-7821
	F	Solder	3439-821-7674
	F	Multimeter 7904729	6625-649-3290
	F	Impedance Measuring 7912149-2	4931-913-2897
	F	Cable Assembly, GR874 to GR874	4931-914-5949
	F	Semiconductor Tester with Probe	4931-914-5185
	F	Heat Sink	(28493) 30A
	F	Galvanometer 7910439	6625-510-1814
	F	Power Supply, DC MIS-10230	4931-115-0567
	F	Cable Assembly, Radio Frequency 3 Required 7907470	4931-846-0010
	F	Tool Kit	5180-650-7821
1-j	D	Tool Kit	5180-650-7821
	D	Solder	3439-821-7674
	D	Multimeter 7904729	6625-649-3290
	D	Capacitance Measuring Assembly 7910842	4931-916-5952
	D	Cable Assembly, GR874 to GR874	4931-914-5949
	D	Semiconductor Tester with Probe	4931-914-5185
	D	Heat Sink	(28493) 30A
	D	Bridge, Resistance 7909149	4931-869-7997
	D	Detector, Galvanometer 7907452	4931-788-0021
	D	Power Supply, Precision 7907279	4931-778-3688
	D	Cable Assembly, Radio Frequency 7907470	4931-846-0010
2-i	F	Galvanometer 7910439	6625-510-1814
	F	Impedance Measuring 7912149-2	4931-913-2897
	F	Power Supply, DC MIS-10230	4931-115-0567
	F	Cable Assembly, Radio Frequency 7907470	4931-846-0010
	F	Tool Kit	5180-620-7821
	F	Solder	3439-821-7674
	F	Multimeter 7904729	6625-649-3290
2-j	D	Bridge, Resistance 7909149	4931-896-7997
	D	Detector, Galvanometer 7907452	4931-788-0021
	D	Power Supply, Precision 7907779	4931-778-3688
	D	Cable Assembly, Radio Frequency 7907470	4931-846-0010
	D	Tool Kit	5180-650-7821
	D	Solder	3439-821-7674
	D	Multimeter 7904729	6625-649-3290
	F	Multimeter 7904729	6625-649-3290
	F	Tool Kit	5180-650-7821

Tool code	Category	Nomenclature	Tool number
3-j	D	Multimeter 7904729	6625-649-3290
	D	Tool Kit	5180-650-7821
4-i	F	Tool Kit	5180-650-7821
	F	Solder	3439-821-7674
	F	Multimeter 7904729	6625-649-3290
	F	Impedance Measuring 7912149-2	4931-913-2987
	F	Cable Assembly, GR874 to GR874	4931-914-5949
	F	Semiconductor Tester with Probe	4931-914-5185
	F	Heat Sink	(28493) 39A
	F	Galvanometer 7910439	6625-510-1814
	F	Power Supply, DC MIS-10230	4931-115-0567
	F	Cable Assembly, Radio Frequency 7907470	4931-846-0010
4-j	D	Tool Kit	5180-650-7821
	D	Solder	3439-821-7674
	D	Multimeter 7904729	6625-649-3290
	D	Capacitance Measuring Assembly 7910842	4931-916-5952
	D	Cable Assembly, GR874 to GR874	4931-914-5949
	D	Semiconductor Tester with Probe	4931-914-5185
	D	Heat Sink	(28493) 30A
	D	Bridge, Resistance 7909149	4931-869-7997
	D	Detector, Galvanometer 7907452	4931-788-0021
	D	Power Supply, Precision 7907279	4931-778-3688
	D	Cable Assembly, Radio Frequency 790470	4931-846-0010

Oscilloscope, 7910655-2

Remarks

Reference Code	Remarks
A-b	Test in accordance with calibration procedure TB 9-6625-963-50
A-c	Clean components and case periodically
A-f	Calibrate in accordance with calibration procedure TB 9-6625-963-50
A-g	Install case No. 14 of calibration van (M292A5)
A-i	Repair in accordance with section 4 of vendors operating and service manual
	Solder all connections per MIL-S-45743
A-j	Repair in accordance with section 4 of vendors operating and service manual
	Solder all connections per MIL-S-45743
B-h	Solder all connections per MIL-S-45743
B-i	Solder all connections per MIL-S-45743
B-j	Solder all connections per MIL-S-45743
C-i	Repair in accordance with section 4 of vendors operating and service manual
C-j	Repair in accordance with section 4 of vendors operating and service manual
D-i	Repair in accordance with section 4 of vendors operating and service manual
	Solder all connections per MIL-S-45743
D-j	Repair in accordance with section 4 of vendors operating and service manual
	Solder all connections per MIL-S-45713

By Order of the Secretary of the Army:

Official:

BRUCE PALMER, JR.,
General, United States Army,
Acting Chief of Staff.

VERNE L. BOWERS
Major General, United States Army,
The Adjutant General.

Distribution:

To be distributed in accordance with DA Form 12-34, Section II (qty rqr block No. 75) Requirements for Calibration Procedures Publications.

* U. S. GOVERNMENT PRINTING OFFICE: 1976-0-211-373/6551B

RECOMMENDED CHANGES TO EQUIPMENT TECHNICAL PUBLICATIONS



THEN . . . JOT DOWN THE DOPE ABOUT IT ON THIS FORM, CAREFULLY TEAR IT OUT, FOLD IT AND DROP IT IN THE MAIL!

SOMETHING WRONG WITH THIS PUBLICATION?

FROM: (PRINT YOUR UNIT'S COMPLETE ADDRESS)

DATE SENT

PUBLICATION NUMBER

PUBLICATION DATE

PUBLICATION TITLE

BE EXACT . . . PIN-POINT WHERE IT IS

IN THIS SPACE TELL WHAT IS WRONG AND WHAT SHOULD BE DONE ABOUT IT:

PAGE NO.

PARA-GRAPH

FIGURE NO.

TABLE NO.

TEAR ALONG PERFORATED LINE

PRINTED NAME, GRADE OR TITLE, AND TELEPHONE NUMBER

SIGN HERE:

DA FORM 2028-2
JUL 79

PREVIOUS EDITIONS
• ARE OBSOLETE.

P.S.—IF YOUR OUTFIT WANTS TO KNOW ABOUT YOUR RECOMMENDATION MAKE A CARBON COPY OF THIS AND GIVE IT TO YOUR HEADQUARTERS.

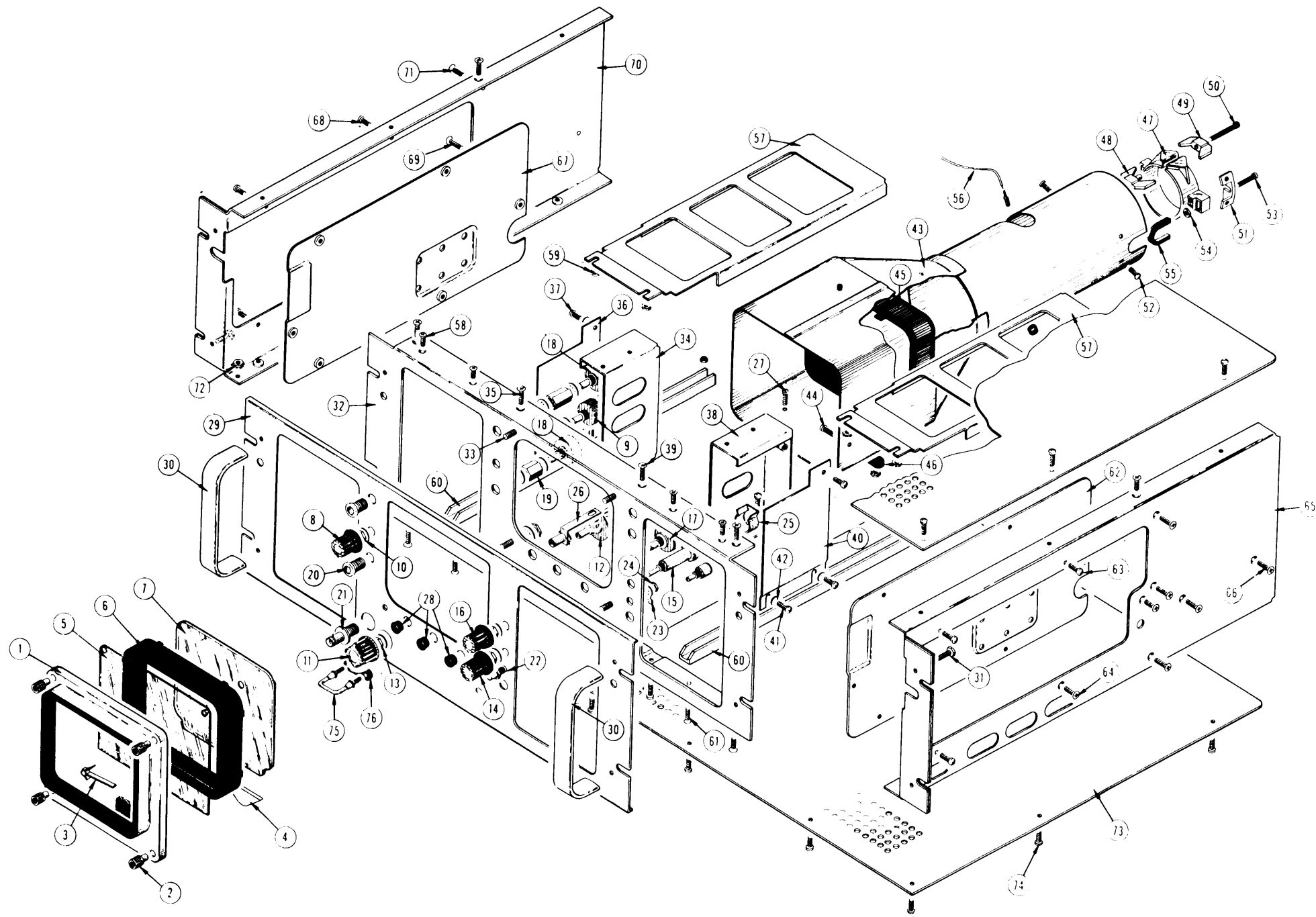

Fig. 1 Front
MECHANICAL PARTS LIST — TYPE R561B

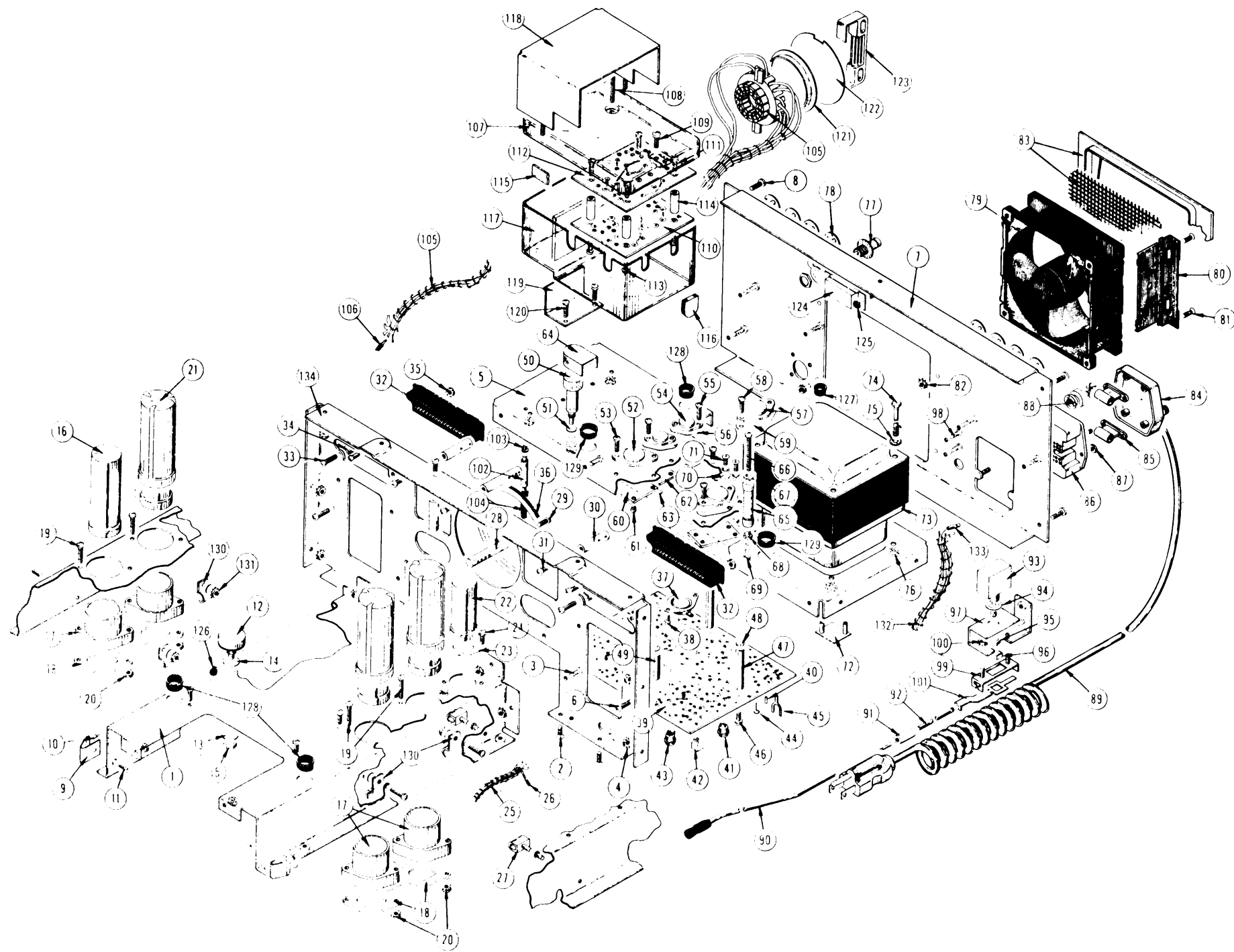

Fig. 2 REAR
MECHANICAL PARTS LIST—TYPE R561B

Voltage readings and waveforms were obtained under the following conditions unless otherwise noted on the individual diagrams:

TYPE R561B

INTENSITY	Counterclockwise
FOCUS	Centered
SCALE ILLUM	Counterclockwise
ASTIGMATISM	Centered
CALIBRATOR	40 V
CRT CATHODE SELECTOR	NORM

Amplifier Unit

Position	Centered
Mode	Normal (Channel 1)
Volts/Div	5
Input Coupling	GND

Time-Base Unit

Position	Centered
Time/Div	1 ms
Sweep Mode	Normal
Level	Free run (clockwise)
Triggering Source	Internal
Triggering Slope	+
Triggering Coupling	Auto
Line voltage	115 VAC
Signal applied	None

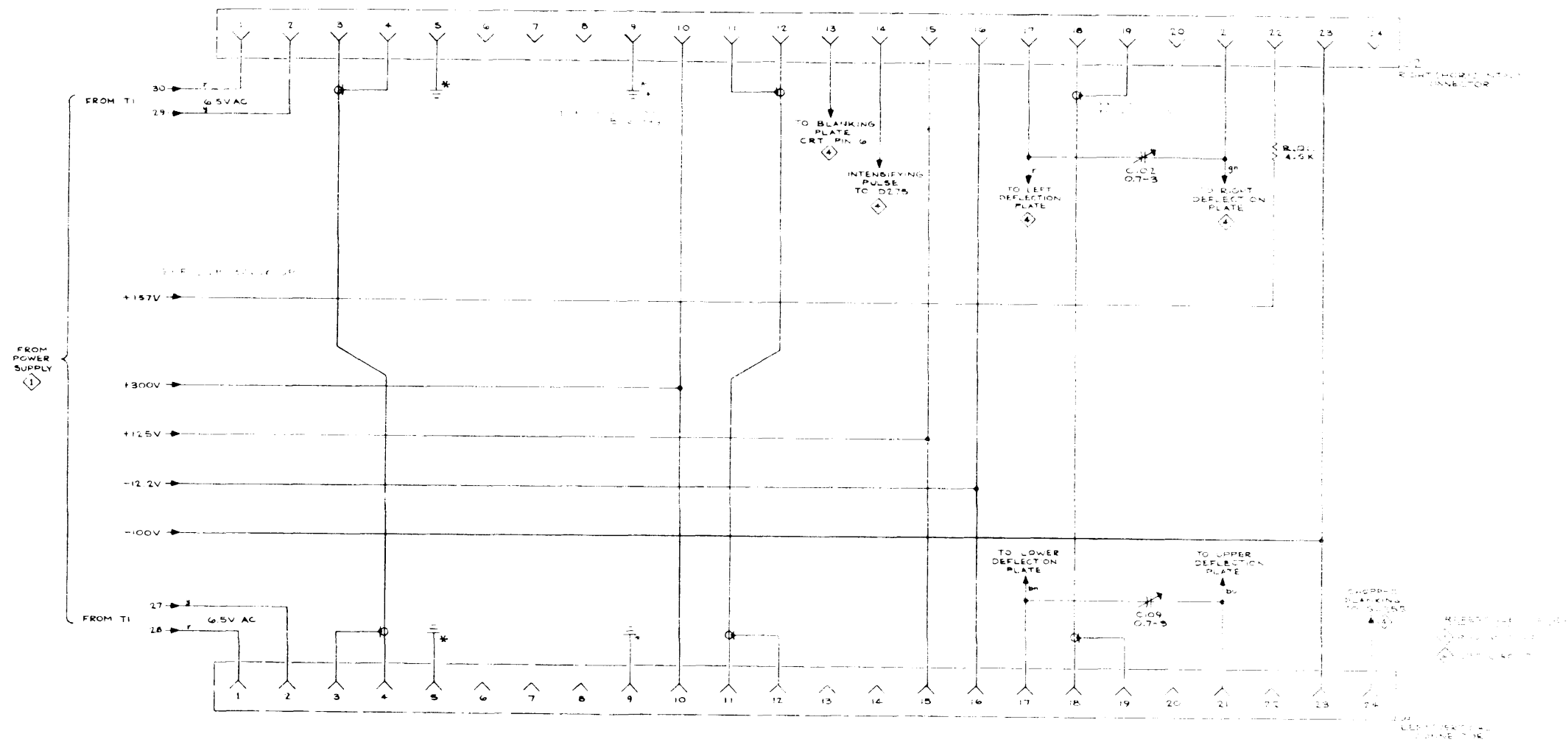

TYPE R561B

PLUG-IN CONNECTOR

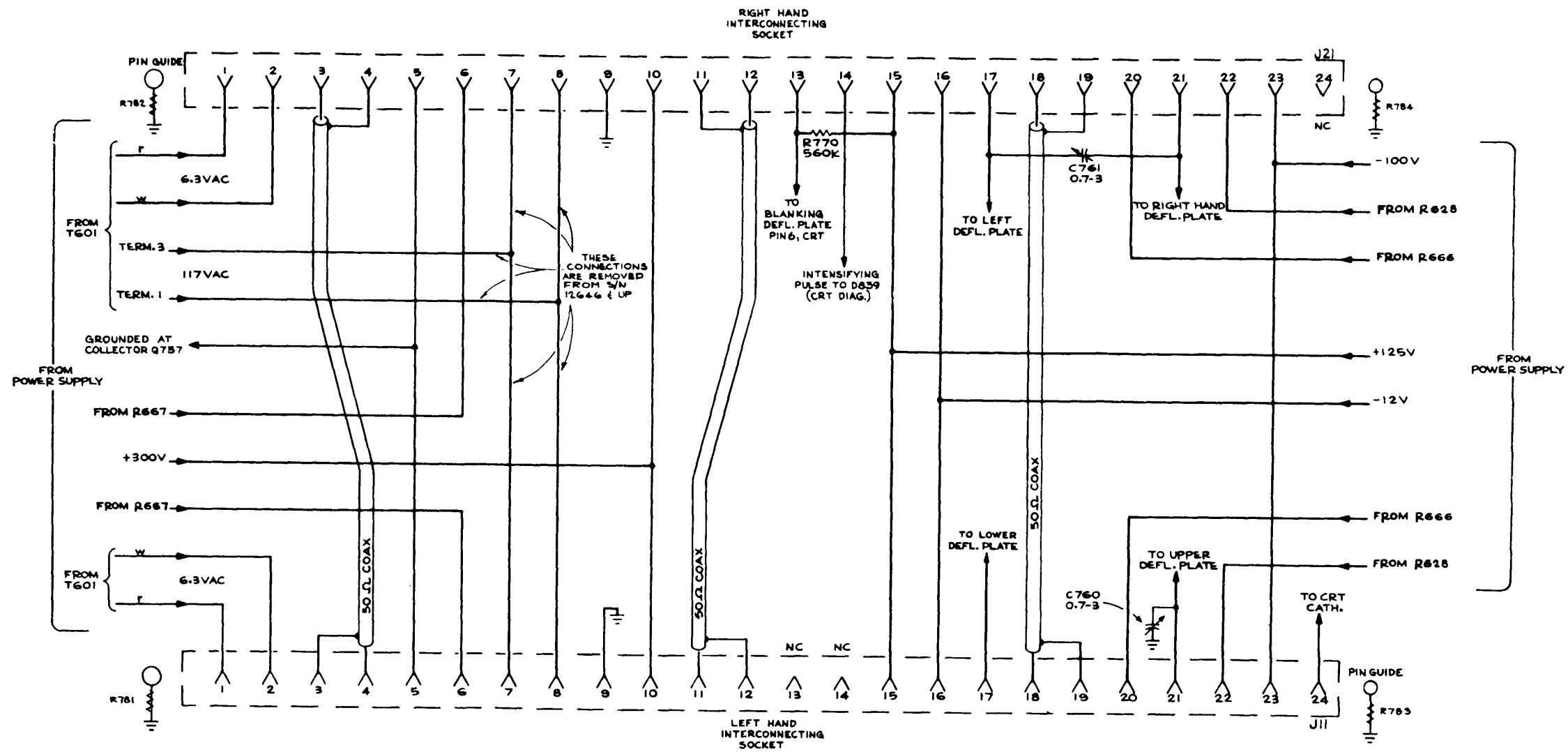

TYPE RM561A OSCILLOSCOPE

D

SEE PARTS LIST FOR EARLIER
VALUES AND SERIAL NUMBER
RANGES OF PARTS MARKED
WITH BLUE OUTLINE

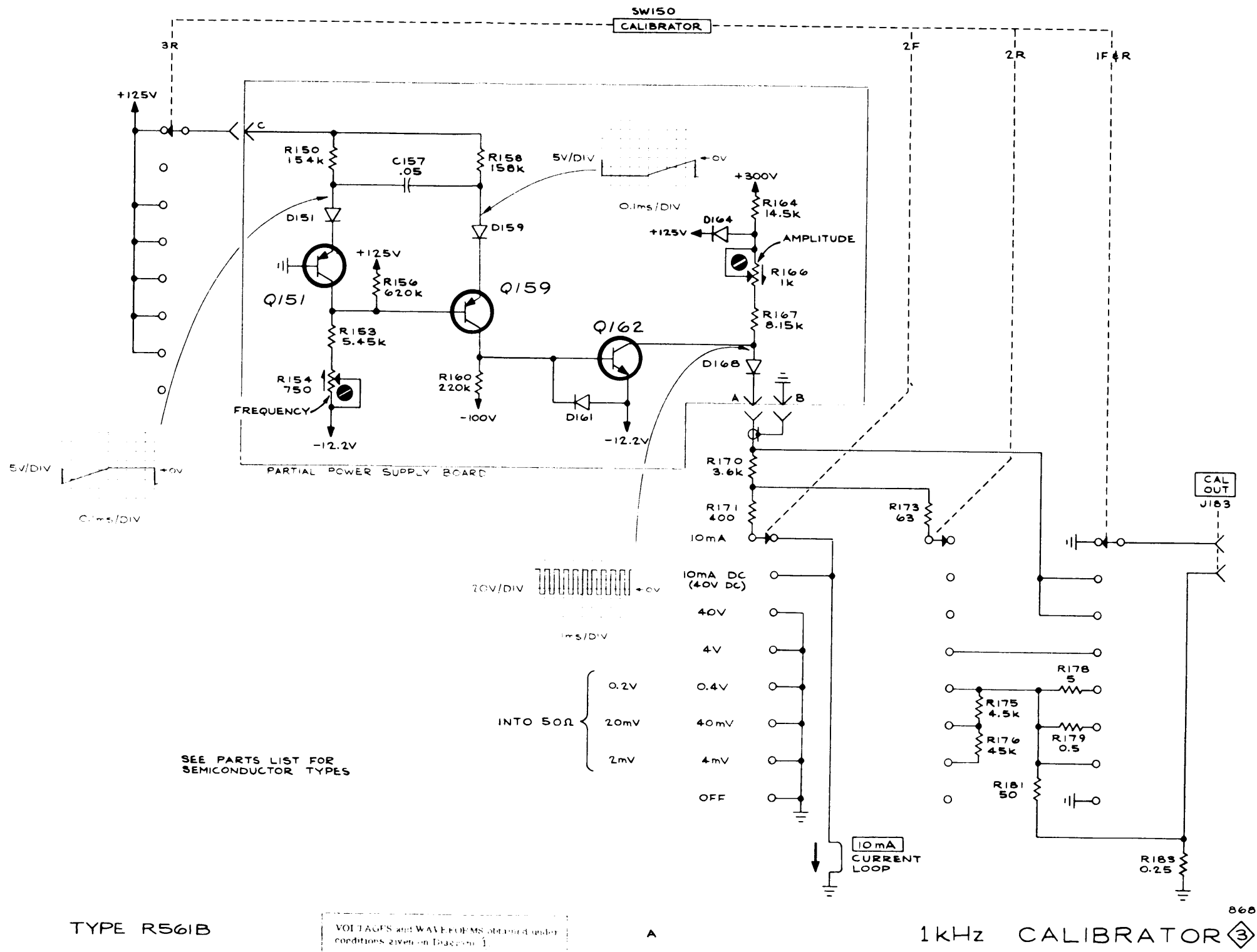

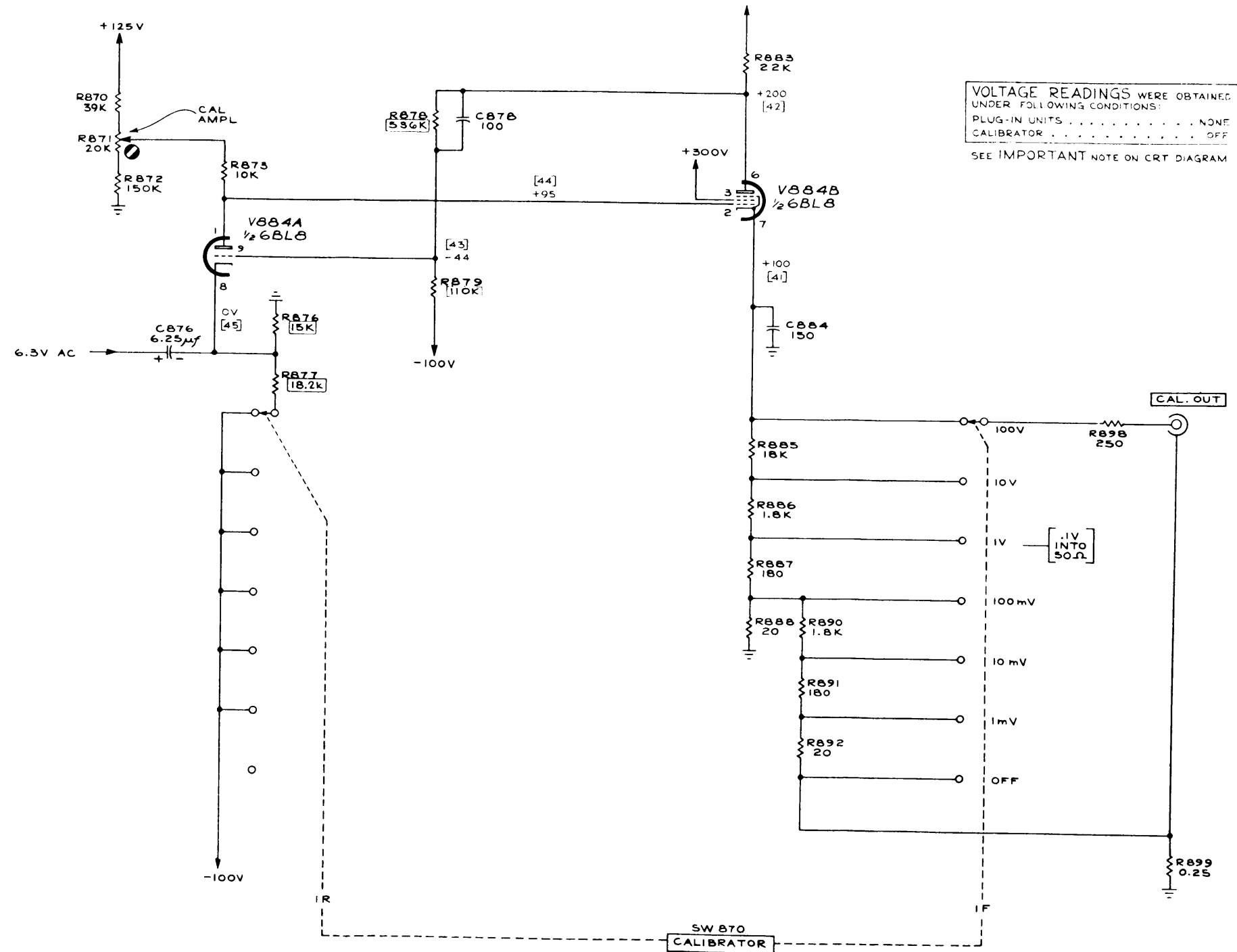

561A OSCILLOSCOPE

C

SEE PARTS LIST FOR EARLIER VALUES AND S/N CHANGES OF PARTS MARKED WITH BLUE OUTLINE

568 PLM CALIBRATOR

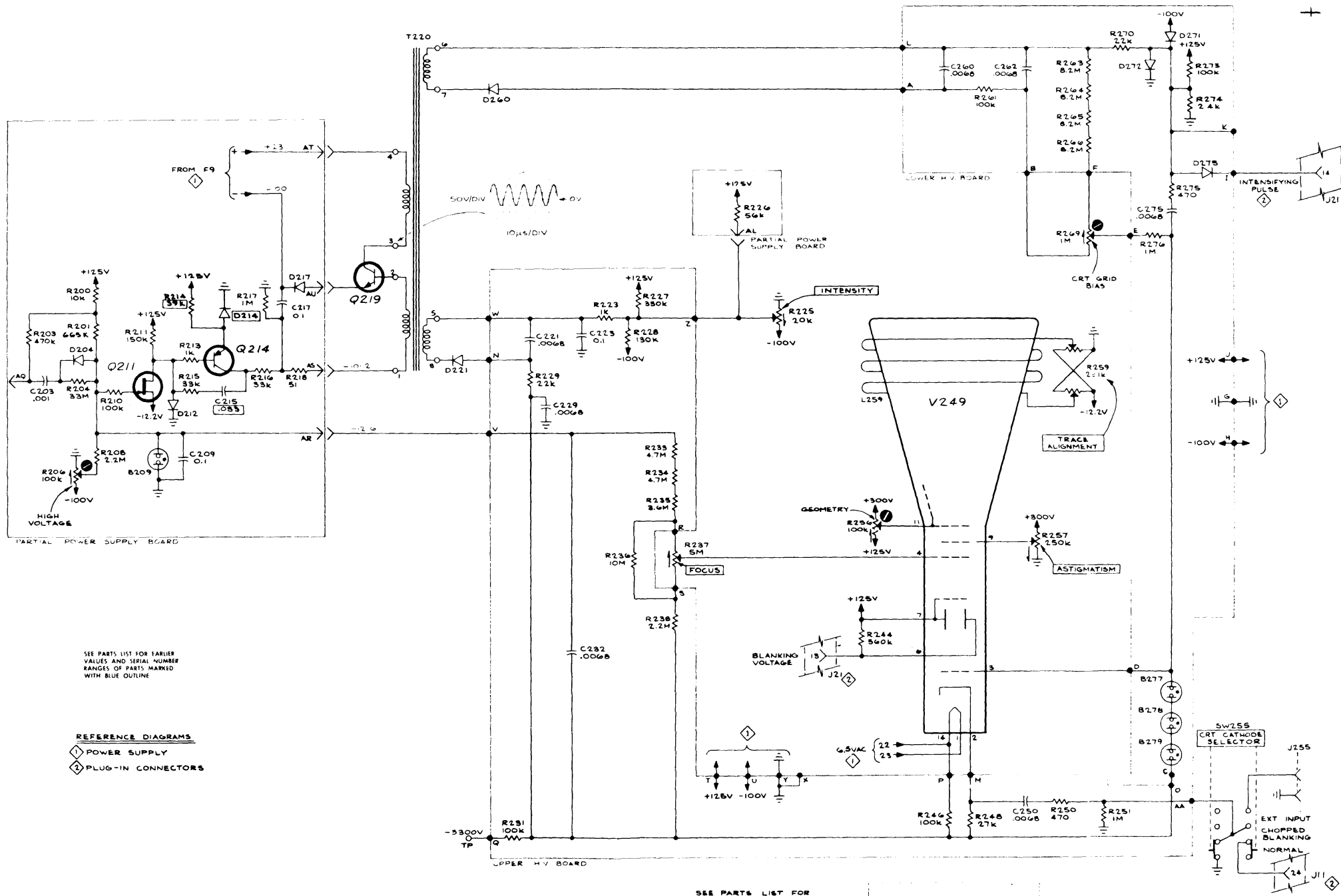

SEE PARTS LIST FOR EARLIER VALUES AND SERIAL NUMBER RANGES OF PARTS MARKED WITH BLUE OUTLINE

- REFERENCE DIAGRAMS
- ① POWER SUPPLY
 - ② PLUG-IN CONNECTORS

SEE PARTS LIST FOR SEMICONDUCTOR TYPES

VOLTAGES and WAVESHAPES shown are conditions given in Diagram 1

TYPE R561B

CRT CIRCUIT ④

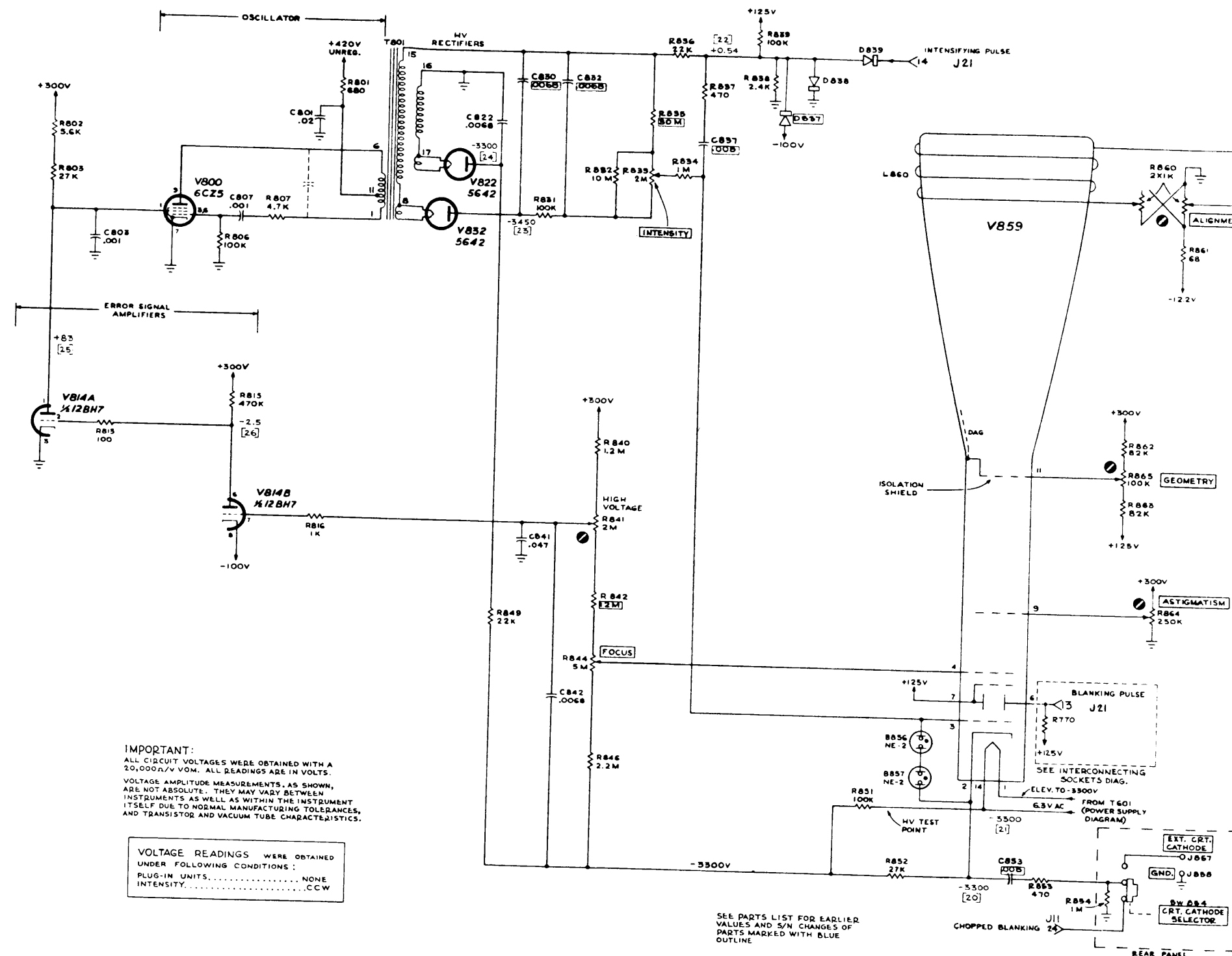

IMPORTANT:
 ALL CIRCUIT VOLTAGES WERE OBTAINED WITH A 20,000Ω/V VOM. ALL READINGS ARE IN VOLTS.
 VOLTAGE AMPLITUDE MEASUREMENTS, AS SHOWN, ARE NOT ABSOLUTE. THEY MAY VARY BETWEEN INSTRUMENTS AS WELL AS WITHIN THE INSTRUMENT ITSELF DUE TO NORMAL MANUFACTURING TOLERANCES, AND TRANSISTOR AND VACUUM TUBE CHARACTERISTICS.

VOLTAGE READINGS WERE OBTAINED UNDER FOLLOWING CONDITIONS:
 PLUG-IN UNITS..... NONE
 INTENSITY..... CCW

SEE PARTS LIST FOR EARLIER VALUES AND S/N CHANGES OF PARTS MARKED WITH BLUE OUTLINE

CRT CIRCUIT
 CIRCUIT NUMBERS 800 THRU 869

TYPE RMS61A OSCILLOSCOPE

PIN: 027977